

Bright The World

Home Resource

2015 - 2016

Collection



Our Vision

To illuminate every part of the world

Our Mission

- To be the leading lighting company in Taiwan and China
 - To be the best at what customers value most
 - To exceed customers expectation
 - Treat staffs & customers & substructures as partnership
 - Enjoy work as part of life
-

Our Core Competence

- Innovation
 - Integrity
 - Efficiency
 - Passion
 - Responsibility
 - Team Work
-

President's Message



Sam Chen MBA

**President & Honorary
Chairman of TLFEA**

■ TLFEA: Taiwan Lighting
Fixture Export Association

Since its establishment in 1988, Home Resource Ind. CO.Ltd. has been dedicated to production and development of lighting products for two decades. We would like to take this opportunity to express our sincere appreciation for your fully supports and concerns over the past 26 years.

With years of efforts on upgrading production capability and capacity, Home Resource has grown into a consummate manufacturer of lightings on OEM (original equipment manufacturing) and ODM (original design manufacturing) basis. Globally reputed R&D talent has also helped Home Resource to enhance popularity and recognition of its own-brand products in recent years.

In addition to existing branches, Home Resource has officially operated a newly constructed plant of 26,000 square meters in China (Zhong Shan City, Guangdong Province), which employs advanced production equipment to assure even shorter delivery and more considerate services for clients than before.

We strive for success not only in having determination and courage, but also developing innovative products and marketing intelligence base on our core competence: innovation, efficiency, integrity and passion. Home Resource will definitely get hold of past success to carry on growing continuously in the lighting territory now and then. Let's witness the brand new, prosperous Home Resource to achieve an even higher peak of success in the coming future.

Company Profile



David Chen

General Manager

Home Resource was established in 1988. Since then, the company has developed into one of the most professional lighting manufactures in Taiwan and Mainland China.

Home Resource/Green Resource would like to express our sincere thanks to all customers, parts sub-contractors and every one of our employees. It is their continuing support and hard work that has allowed Home Resource/Green Resource to grow as rapidly as they have been able to. HR&GR will continue to make even greater efforts in the future.

Other than a self-support manufacturer, through a presence in Ningbo and Zhongshan and 50 employees, Home Resource also operates a sourcing network of two offices in China.

We strive to attain a position of long-term, sustainable pre-eminence in the lighting field "lighting up" both our customers and ourselves.

We look forward to working with you all continuously to create a brilliant future.

► Taipei Headquarter



► China Factory



► Sales Team



► Production Line



► China Show Room

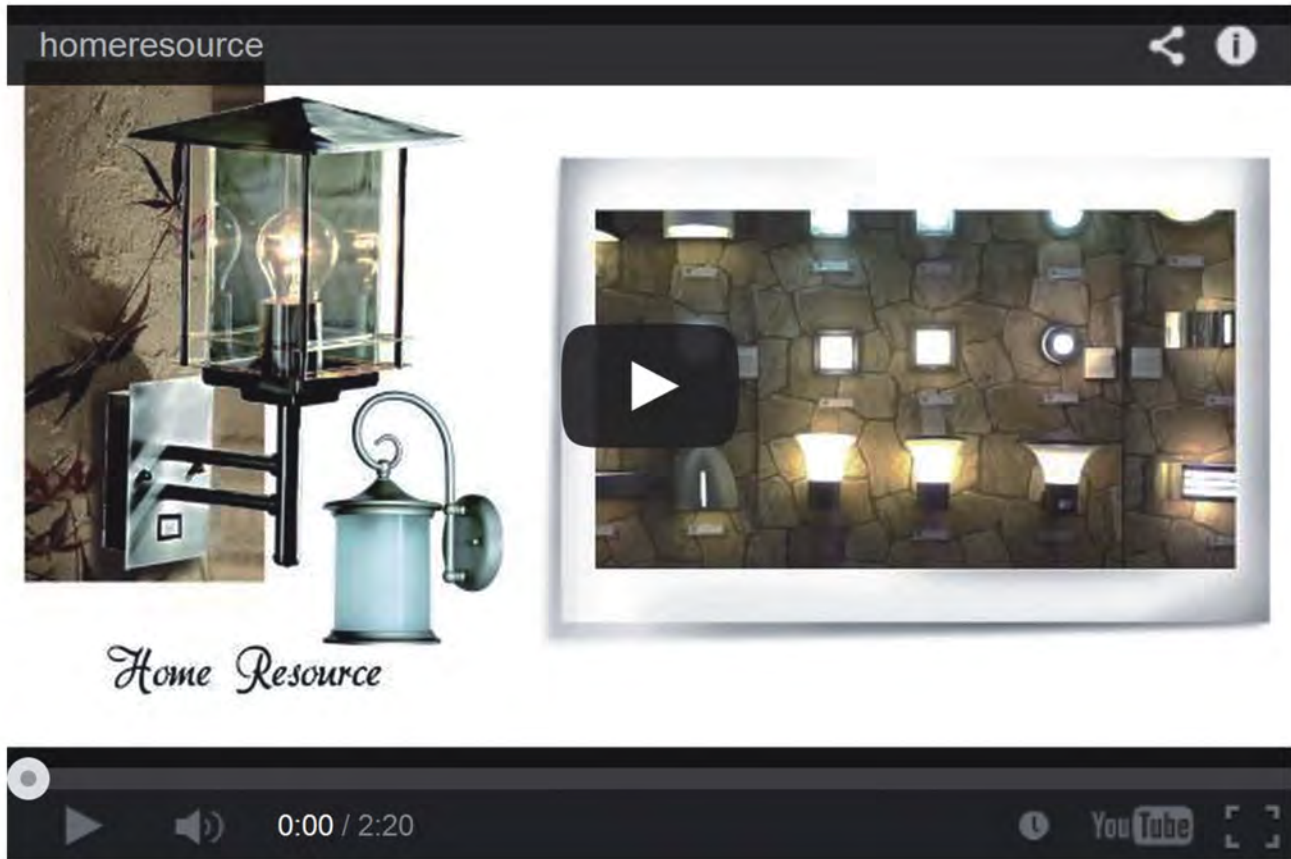

Exterior Wall Light



Exterior Garden Light



Stainless Steel Garden Light



Exterior Bulkheads

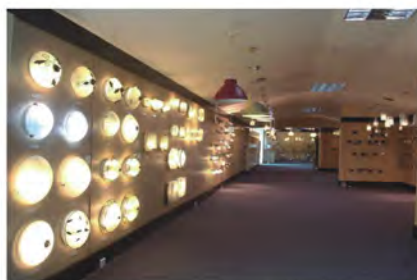

Interior Ceiling Light



LED Table Lamp



Novelty Light & Mood Light



In-ground Light & Deck Light

► Test Facilities



Integrator Machine Set



Integrator Machine Set



Integrator Machine Set (To test Color Temperature, Luminous Flux, Ra ...)



Salt Spary Test Machine (To test Anti-corrosion status of metal material)



LCR Test Machine (To test Electrical resistance, Capacitance, Inductance)



Switching Power (To Adjust Voltage and Frequency when conducting aging test)



Instrument for Color Temperature Contrast



Lampholder Torsion Test Machine (Torsion test after the lampholder is assembled)



LED Aging Test Machine (Mainly use to test High Power LED)



LED Luminous Intensity Meter (To test the bright of LED)

HOME RESOURCE has received the following awards:

Design Awards:



■ Good Design Product of Taiwan



■ Red Dot Award of Germany



L: Sam Chen
(President of Home Resource Co.)

R: Alfred Albrecht, TUVPS
(GS Testing & Certification Body)

- Awarded from TUVPS as one of the Top 5 golden clients in 2003



L: Sam Chen
(President of Home Resource Co.)

R: P.K. Chiang
(Minister of Economic Department Taiwan)

- Being elected as Chairman of TLFEA in 2004
- TLFEA: Taiwan Lighting Fixture Export Association



L: Jack Chen, Former President of HR/GR
R: Representative of Senior Group

- Award from Senior Group
Towards Annual Charity Donation

- The best innovation award of TLFEA 1993, 1994 and 2002
- Asia-pacific area golden quality award 1995
- In 1995, HR being the 1st Taiwanese company in receipt of NEMKO SEMKO, DEMKO, FI Certificate Excellent quality award, Spain 1996
- The excellent manufacture & export golden globe award in Taiwan 1997
- National excellent lighting quality award in Japan 1998
- Awarded as one of the best 'ISO 9001:2000' companies listed as members of KEMA organization in 1999 & 2004
- The best image award of Taiwan lighting fixture export association 1996 & 1997 & 1998 & 1999 & 2000 & 2001
- National quality award in Taiwan in 2002 & 2003 & 2004 & 2005 & 2006
- Good Design Product, Taiwan, since 2008
- Red Dot Design Award: product design 2008, Germany
- The Most Popular Product of Award in 2009 from Taiwan External Trade Development Council

► Safety Approval: CE, GS, CUL, ETL



GS Certificate

CUL, ETL Certificate



CE Certificate

► More than 60 patents...

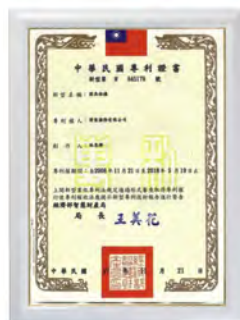
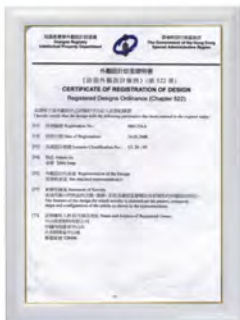



虹瑞斯

Home Resource

Since 1988

Manufacturer

&

Buying Agent

&

I

nspection

Agent

INDEX

Exterior Light

◆ Exterior Garden Light.....	P11-P40
◆ Exterior Wall Light & Spot Light.....	P41-P78
◆ Exterior Rechargeable Work Light.....	P79-P81
◆ Exterior Non-Rechargeable Work Light.....	P82-P89
◆ Exterior Ground Light & Deck Light.....	P90-P93
◆ Exterior Bulkhead & Ceiling Light.....	P94-P101
◆ Exterior Fluorescent Light.....	P102-P104

Interior Light

◆ Interior Cabinet Light & Kitchen Light.....	P106-P114
◆ Interior Picture Light.....	P115-P120
◆ Interior Mood Light & Novelty Light.....	P121-P138
◆ Interior Strip Light.....	P139-P140
◆ Interior Reading Light.....	P141-P171
◆ Interior Fluorescent Light.....	P172-P173
◆ Interior Ceiling Light.....	P174-P175
◆ Interior Bathroom Light.....	P176-P180
◆ Interior Pendant Light.....	P181-P185
◆ Interior Decorative Light.....	P186-P191
◆ Interior Spot Light.....	P192-P211
◆ Interior Down Light.....	P212-P218

Commercial Light.....	P219-P224
------------------------------	------------------

Lighting & Electrical Accessories

◆ USB Light.....	P226-P227
◆ Wardrobe Light.....	P228-P231
◆ Flash Light.....	P232-P235
◆ Sensor & Sensor Socket.....	P236-P241
◆ Travel Adapter.....	P242-P244
◆ Bulb & Tube.....	P245-P248

Commercial Light

HOME RESOURCE 2015~2016 COLLECTION



LED Down Light

- Material: Aluminum
- Finish: White
- External Driver (Inclu.)

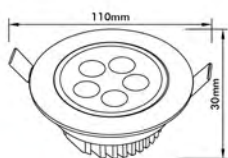

● DLED-S862

5W (5x1W LED)
Luminous: 400lm (6500K)
CRI(Ra): >80
LED Beam Angle: 60°

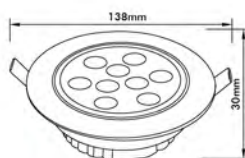

● DLED-862

9W (9x1W LED)
Luminous: 720lm (6500K)
CRI(Ra): >80
LED Beam Angle: 60°

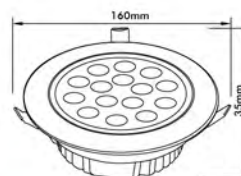

● DLED-M862

15W (15x1W LED)
Luminous: 1050lm (6500K)
CRI(Ra): >80
LED Beam Angle: 60°



● DLED-867

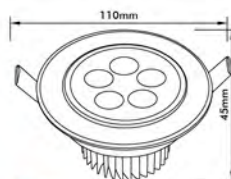

5W
5W (5x1W LED)
Luminous: 400lm (6500K)
CRI(Ra): >80
LED Beam Angle: 60°

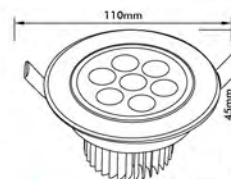

7W
7W (7x1W LED)
Luminous: 560lm (6500K)
CRI(Ra): >80
LED Beam Angle: 60°

LED Down Light

- Material: Aluminum + PC
- Finish: Silver/White

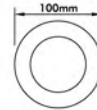

● **DLED-56S**
6W
(60 x 0.1W SMD3528 LED)

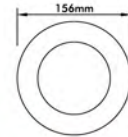

● **DLED-56**
12W
(120 x 0.1W SMD3528 LED)

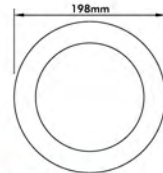

● **DLED-56M**
15W
(150 x 0.1W SMD3528 LED)

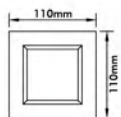

● **DLED-58S**
6W
(60 x 0.1W SMD3528 LED)

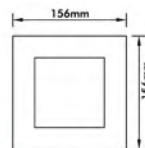

● **DLED-58A**
12W
(120 x 0.1W SMD3528 LED)

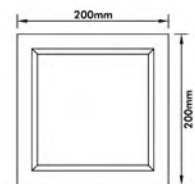

● **DLED-58M**
15W
(150 x 0.1W SMD3528 LED)

LED High Bay

- Material: Aluminum
- Finish: Silver
- Input Voltage: 220V
- Luminous Flux: 90lm/W
- Color Temperature: 2700~7000K
- IP20



● **HBLED-11**

Power: 100W COB LED
Product size: Ø430mm



● **HBLED-12**

Power: 50W COB LED
Product size: Ø450mm



● **HBLED-14**

Power: 100W COB LED
Product size: Ø510mm



LED Panel Light

- Material: Aluminum + PMMA
- Input Voltage: 100V~240V
- Color Temperature: 2800K~7000K
- Ra>80
- IP20

CE  RoHS EMC

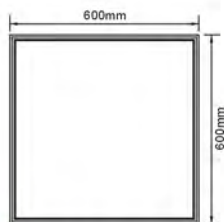

● PALED-6060

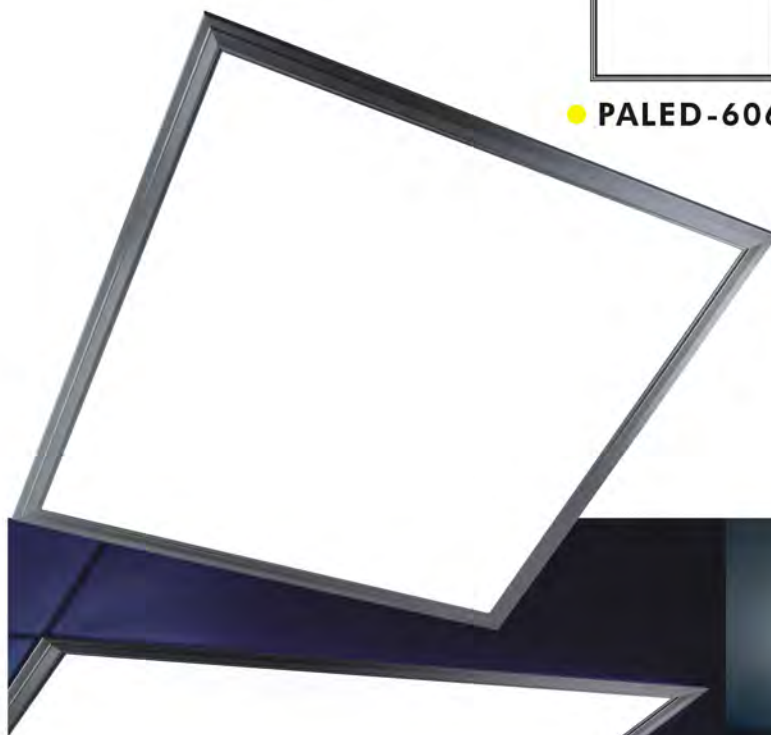

Model No.	Size (cm)	LED	Watt	Luminous Flux (LM)
PALED-6060	60 x 60 x 1.2cm	180ps (SMD2835)	36W	2700LM
PALED-6060	60 x 60 x 1.2cm	192ps (SMD2835)	40W	3000LM
PALED-6012	60 x 120 x 1.2cm	192ps (SMD2835)	40W	3000LM
PALED-3012	30 x 120 x 0.9cm	192ps (SMD2835)	40W	3000LM
PALED-3012	30 x 120 x 0.9cm	216ps (SMD2835)	42W	3150LM
PALED-3030	30 x 30 x 1.2cm	96ps (SMD2835)	20W	1500LM
PALED-3060	30 x 60 x 1.2cm	96ps (SMD2835)	20W	1500LM

LED Sign Light

- Material: Alu. Body
- Lamp: 3W LED (6000K/Cool White)
- Finish: Silver
- IP44

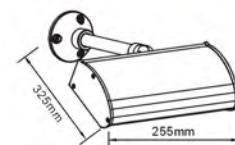

● **SNLED-132B1**
2 x 3W = 6W
6000K: 360Lm

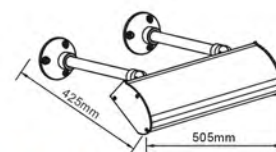

● **SNLED-133B2**
3 x 3W = 9W
6000K: 420Lm

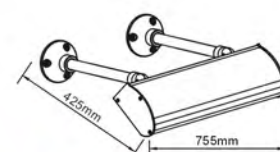

● **SNLED-135B2**
5 x 3W = 15W
6000K: 700Lm

Lighting & Electrical Accessories

HOME RESOURCE 2015~2016 COLLECTION

USB Light

Wardrobe Light

Flash Light

Sensor & Sensor Socket

Travel Adapter

Bulb & Tube



USB Light

HOME RESOURCE 2015~2016 COLLECTION



USB LED Portable Reading Lamp-Yoyo

- Material: PC Body + Iron Gooseneck
- Lamp: 0.5W SMD5630 LED Modules
- Luminous flux: 30Lm(5000K)
- Finish: White/Black/Pink/Blue/Orange/Green
- With Black USB Plug + Black Flexible Tube
- Illuminance(20cm): >300Lux

0.5W LED
Super Bright
300 Lux(20cm)



Blue



Pink



Green



White



Black



Orange

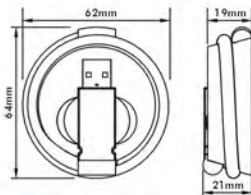

●● BLED-006

Method of use:

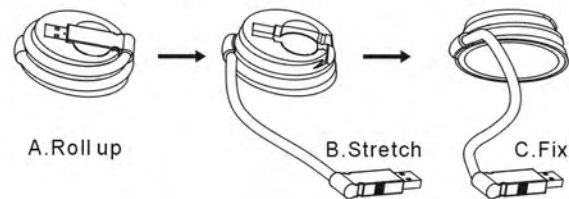

(Recommended position)



Wardrobe Light

HOME RESOURCE 2015~2016 COLLECTION



LED Wardrobe Light

- Material: ABS
- Lamp: 3 x 0.1W LEDs
- LED Light Color: White
- Battery: 3 x AAA(Excl.)
- With Vibration Sensor
- Finish: Gray

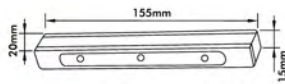

● **WDLED-003B**



- Material: ABS
- With PIR Sensor
- Lamp: 6 x 0.1W LEDs
- Battery: 5 x AAA(Excl.)
- Sensor Detection Distance: 2M
- Sensor Detection Range(Max.): 60°
- Finish: Gray

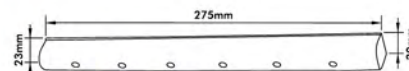

● **WDLED-002A**



- Material: ABS
- Lamp: 2 x 0.1W LEDs
- LED Light Color: White
- Battery: 3 Button Batteries(Incl.)
- With Vibration Sensor
- Finish: Gray



● **WDLED-008B**



LED Clothes Hanging Bar

- Material: Aluminum
- Finish: Aluminum
- 5pcs AAA Batteries Excl.
- Hanging Bracket x 2

Length	LEDs (6400K)	Max. length allowable to cut
40CM	6 x 0.1W	10CM
60CM	8 x 0.1W	30CM
80CM	10 x 0.1W	50CM
100CM	12 x 0.1W	70CM
120CM	14 x 0.1W	90CM

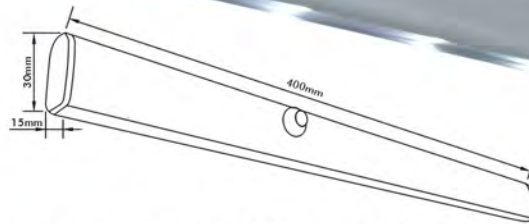
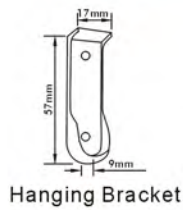

- **HALED-001A - With Motion Sensor**
- **HALED-001B - With Vibration Sensor**



LED Wardrobe Light

- Material: ABS
- Lamp: 6 x 0.1W LEDs
- LED Light Color: White
- Battery: 5 x AAA(Excl.)
- Finish: Gray



● WDLED-011A

- With Body Sensor (PIR Sensor)

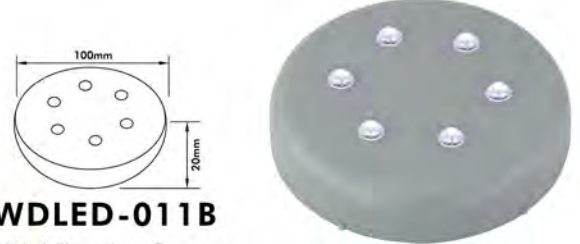

● WDLED-011B

- With Vibration Sensor

- Material: ABS
- Lamp: 8 x 0.1W SMD3528 LED
- LED Light Color: White
- Battery: 3 x AAA(Excl.)
- Finish: White



● WDLED-010A

- With Body Sensor (PIR Sensor)

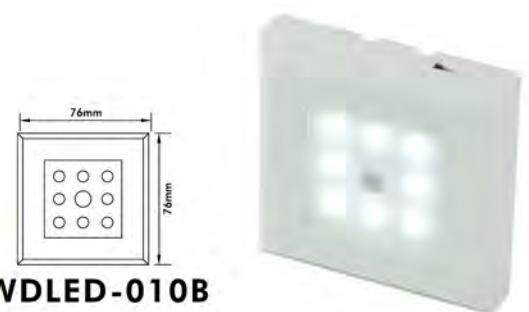

● WDLED-010B

- With Vibration Sensor

- Material: ABS
- Lamp: 6 x 0.1W LEDs(6400K)
- Finish: Gray/White
- 5pcs AAA Batteries Excl.
- Motion Sensor: 60° & Max 2M

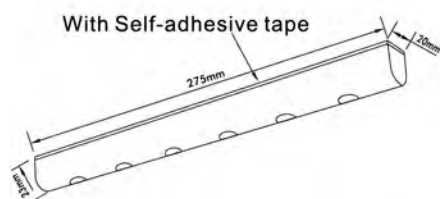
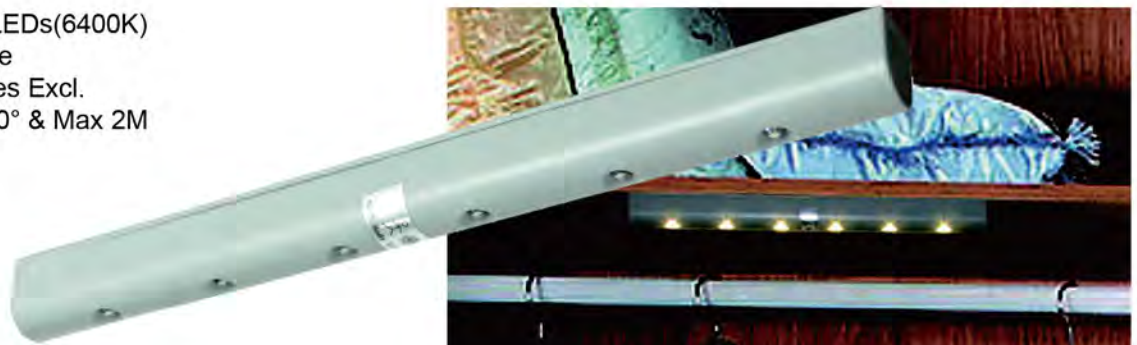

- WDLED-002A - With Motion Sensor
- WDLED-002B - With Vibration Sensor



Flash Light

HOME RESOURCE 2015~2016 COLLECTION



LED Sensor Light



CE RoHS EMC

● BO-LED17

16 + 2 LED Sensor Light
Sensor Light + Torch

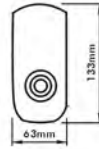

- Material: Plastic
- With Charger
- LED : Top - 2pcs (1W) / Side - 16pcs (1W)
- Battery: Li-ion 3.7V 500mAh
- Battery charging hours: 8~10H
- Torch use: Working time 1.5H for Top / 2H for Side
- Sensor Light use: Photocell & PIR function
2~3M, 25+/-5S, 60° , Side on
- Emergency use: Side On 2H



Push Switch at side for Torch use:
Side On - Top On - Off

LED Sensor Light



● BO-LED19

14 + 6 LED Sensor Light
Sensor Light + Torch

- Material: Plastic
- With Charger
- LED : Top - 6pcs (0.42W) / Side - 14pcs (1W)
- Battery: 14430 Li-ion 3.7V 650mAh
- Battery charging hours: 6~8H
- Torch use: Working time 12H for Top / 2.5H for Side
- Sensor Light use: Photocell & PIR function
2~3M, 25+/-5S, 60° , Side on
- Emergency use: Side On 2.5H

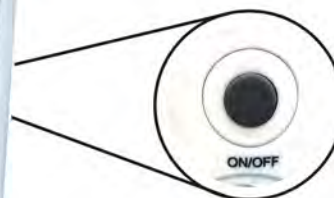
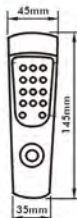

Push Switch at backside for Torch use:
Side On - Top On - Off

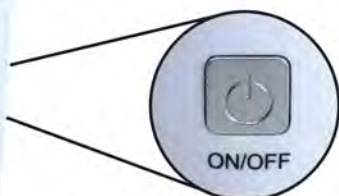

Push Switch at front for Torch use:
Side On - Top On - Off

● BO-LED20

15 + 5 LED Sensor Light
Sensor Light + Torch

- Material: Plastic
- With Charger
- LED : Top - 5pcs (0.35W) / Side - 15pcs (1W)
- Battery: 502030 Li-ion 3.7V 250mAh
- Battery charging hours: 6~8H
- Torch use: Working time 5H for Top / 1.5H for Side
- Sensor Light use: Photocell & PIR function
2~3M, 25+/-5S, 60° , Side on
- Emergency use: Side On 1.5H

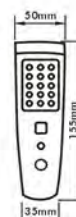

LED Sensor Light



● BO-LED21

6+10 LED Sensor Light
Sensor Light + Torch



- Material: Plastic
- With Charger
- LED : Top - 10pcs (0.7W) / Side - 6pcs (0.42W)
- Battery: Li-ion 3.7V 500mAh
- Battery charging hours: 8~10H
- Torch use: Working time 1.5H for Top / 3H for Side
- Sensor Light use: Photocell & PIR function
3~4M, 25+/-5S, 60° , Side on
- Emergency use: Side On 3H
- Switch for Top Light: 100% bright - 50% bright - Flashing



Push Switch at front for Torch use:
Side On - Top On - Off



Switch for Top Light



Push Switch at backside
for Torch use:
Side On - Top On - Off



● BO-LED22

5+1 LED Sensor Light
Sensor Light + Torch

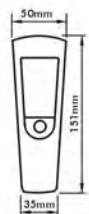

- Material: Plastic
- With Charger
- LED : Top - 1pc (1W) / Side - 5pcs (0.35W)
- Battery: Li-ion 3.7V 650mAh
- Battery charging hours: 8~10H
- Torch use: Working time 3H for Top / 6H for Side
- Sensor Light use: Photocell & PIR function
2~3M, 25+/-5S, 60° , Side on
- Emergency use: Side On 6H



Sensor & Sensor Socket

HOME RESOURCE 2015~2016 COLLECTION



Infrared Motion Detector PIR Sensor

- Material: Plastic + Metal
- Power Source: 110~130V/AC OR 220~240V/AC
- Work Temperature: -20°C ~ +40°C
- Available Color: Black / White
- IP20

CE  RoHS EMC





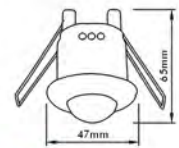





● HR-S16A



● HR-S17



ITEM	HR-S16A	HR-S17
Detection Distance (22~24°C)	6M MAX	6M MAX
Detection Angle (Max)	360°	360°
Total Max. Rated Load	800W (110~130V/AC)  1200W (220~240V/AC)  200W (110~130V/AC)  300W (220~240V/AC) 	300W (110~130V/AC)  500W (220~240V/AC)  100W (110~130V/AC)  150W (220~240V/AC) 
Installation Height	1.5~3.5M	1.5~3.5M
Time Delay (adjustable)	10±3Sec~8±2Min	5Sec~10±2Min
Ambient Light (adjustable)	<10~2000Lux	<10~2000Lux

Infrared Motion Detector PIR Sensor(Outdoor Use)

- Material: Plastic + Metal
- Power Source: 110~130V/AC OR 220~240V/AC
- Work Temperature: -20°C ~ +40°C
- Available Color: Black / White
- IP44

CE  RoHS EMC





● **HR-S51**

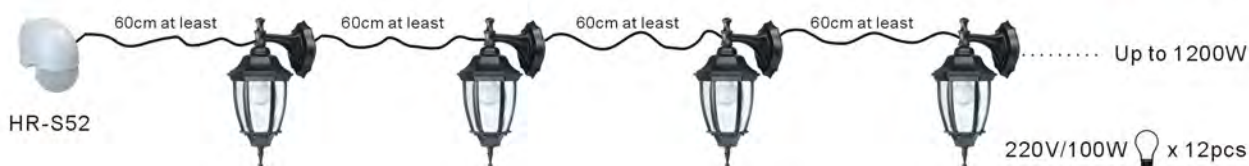

● **HR-S52**





ITEM	HR-S51	HR-S52
Detection Distance (22~24°C)	12M MAX	12M MAX
Detection Angle (Max)	180°	180°
Total Max. Rated Load	800W (110~130V/AC)  1200W (220~240V/AC)	200W (110~130V/AC)  300W (220~240V/AC)
Installation Height	2~4.5M	1.8~2.5M
Time Delay (adjustable)	10±3Sec~8±2Min	10±3Sec~7±2Min
Ambient Light (adjustable)	<10~2000Lux	<3~2000Lux
Remark	With indicator to show it works normally	

Motion Detector(Sensor Socket)

- Material: Plastic + Metal
- Power Source: 220~240V/AC only
- Adaptable Plug: EU plug (German type or French type)
- Work Temperature: -20°C ~ +40°C
- Available Color: Black / White
- IP20

CE  RoHS EMC

ITEM	HR-S73
Detection Distance (22~24°C)	9M MAX (adjustable)
Detection Angle (Max)	120°
Max. Rated Load	1200W (220~240V/AC) 
	300W (220~240V/AC) 
Installation Height	1~1.8M
Time Delay (adjustable)	10±3Sec~7±2Min
Ambient Light (adjustable)	<3~2000Lux
Remark	AUTO / OFF / ON

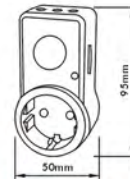
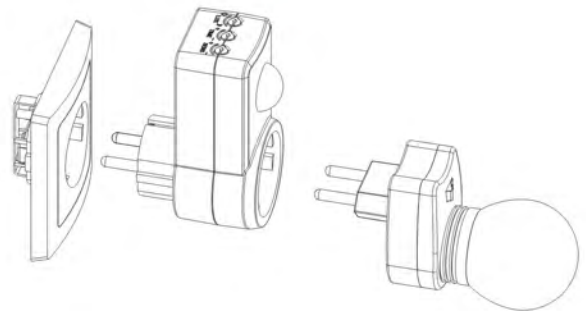

● HR-S73



(French socket)



(German socket)

Motion Detector(PIR Sensor)

- Rated Load: 1200W(220-240V/AC) or 800W(110-130V/AC)
- Power Source: 220-240V/AC or 110-130V/AC
- Ambient Temperature: -20 - +40°C



● HR-S9



● HR-S10



● HR-S11



● HR-S12



● HR-S13



● HR-S15

ITEM	HR-S9	HR-S10	HR-S11	HR-S12	HR-S13	HR-S15
Detection Distance	12m	12m	9m	12m	2-12m	12m
Detection Range (Max)	360°	360°	140°	180°	180°	180°
Installation Height	1.5-3.5m	1.5-3.5m	1-1.6m	0.5±3.5m	1.8-2.5m	0.5±3.5m
Time Delay	5Sec.-9Min	5Sec.-9Min	5Sec.-9Min	8Sec.-8Min	5Sec.-8Min	8Sec.-8Min
IP	20	20	20	44	44	44

Motion Detector(PIR Sensor)

- Power Source: 110-130V/AC, 220-240V/AC
- Working Temperature: -20-+40°C



● HR-S1



● HR-S2



● HR-S3



● HR-S4



● HR-S5



● HR-S6



● HR-S8

Item	S1	S2	S3	S4	S5	S6	S8
Detection Distance	10±2M	10±2M	12±2M	10±2M	10±2M	19M	13M
Detection Range(Max)	360°	140°	180°	360°	180°	110°	180°
Rated Load	1000W	500W	1000W	1000W	500W	1500W	1000W
Installation Height	2~4.5M	0.4~1.8M	0.5~3.5M	2~4.5M	2~4.5M	2~4.5M	2~4.5M
IP	20	20	44	44	44	44	44
Sensitivity(Sound Control)	-	30db~90db	-	-	-	-	-

ITEM	HR-S14
Detection Distance	9m
Detection Range (Max)	180°
Rated Load	200W(220-240V/AC) or 100W(110-130V/AC)
Installation Height	1-1.6m
Time Delay	5Sec.-9Min
	20



● HR-S14

Travel Adapter

HOME RESOURCE 2015~2016 COLLECTION



World Universal Travel Adapter

- Material: High-gloss Plastic New PC with fire prevention material
- Power Source: 100V AC-250V AC, 6A
- With Double USB: Output 5V Total 1000MA for 2 USB ports
- Available color: White, Black
- Converts UK/US/AU/EU Plugs

●● TFE-721USB2

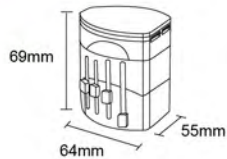

CE FC



Europe



UK



Australia



USA

World Universal Travel Adapter

- Material: High-gloss Plastic New PC with fire prevention material
- Power Source: 100V AC-250V AC, 6A
- With Double USB: Output 5V 1000mA, Max: 2100MA
- Available color: Matt Black (Rubber Paint Effect) / Shiny White
- Converts UK/US/AU/EU Plugs

●● TFE-722USB2

With Double USB: Output 5V 1000mA, Max: 2100MA



Australia



UK



USA



Europe

Bulb & Tube

HOME RESOURCE 2015~2016 COLLECTION



LED BULB

Specifications

Item No.	GU10LED-3W50-4GK5	GU10LED-4W50-4GK5	GU10LED-5W50-4GK5	GU10LED-6W50-4GK5
Voltage	100-240V	100-240V	100-240V	100-240V
Wattage	3W	4W	5W	6W
Angle	120°	120°	120°	120°
CCT	6000K	6000K	6000K	6000K
CRI	Ra>80	Ra>80	Ra>80	Ra>80
Luminous Flux	180lm	320lm	400lm	450lm
Lifetime	40000hrs	40000hrs	40000hrs	40000hrs
Product Size	Ø50*49mm	Ø50*53mm	Ø50*60mm	Ø50*60mm



Specifications

Item No.	MR16LED-3W50-4GK5	MR16LED-5W50-4GK5	MR16LED-6W50-4GK5
Voltage	12V	12V	12V
Wattage	3W	5W	6W
Angle	120°	120°	120°
CCT	6000K	6000K	6000K
CRI	Ra>80	Ra>80	Ra>80
Luminous Flux	180lm	320lm	450lm
Lifetime	40000hrs	40000hrs	40000hrs
Product Size	Ø50*49mm	Ø50*54.5mm	Ø50*65mm



Specifications

Item No.	E27LED-3WB3-4GK5	E27LED-5WB3-4GK5	E27LED-7WB3-4GK5
Voltage	100-240V	100-240V	100-240V
Wattage	3W (14ps x SMD2835)	5W (24ps x SMD2835)	7W (34ps x SMD2835)
Angle	—	—	—
CCT	6000K	6000K	6000K
CRI	Ra>80	Ra>80	Ra>80
Luminous Flux	240lm	400lm	560lm
Lifetime	40000hrs	40000hrs	40000hrs
Product Size	Ø55*108mm	Ø60*118mm	Ø70*128mm



Specifications

Item No.	E14LED-3WB3-4GK5	E14LED-4WB3-4GK5
Voltage	100-240V	100-240V
Wattage	3W (1*3W COB)	4W (1*4W COB)
Angle	270°	270°
CCT	6000K	6000K
CRI	Ra>80	Ra>80
Luminous Flux	300lm	400lm
Lifetime	40000hrs	40000hrs
Product Size	Ø36*102mm	Ø36*102mm



Halogen Bulbs



● **JDR**

E14 or E27 Cap
With UV Filter
C Class 14W
C Class 25W
C Class 35W
110V-240V



● **GU10**

With Ceramic Base or Glass Base
With UV Filter; With or W/O Glass Cover
C Class 28W
C Class 40W
110V-240V



● **GZ10**



● **MR-11**

G4
C Class 12V/14W
C Class 12V/25W



● **MR-16**

G6.35
With or W/O Glass Cover
With UV Filter
C Class 12V/14W
C Class 12V/25W



● **JC-6.35**

G6.35
12V/20W
12V/35W
12V/50W



● **JC-4**

G4
12V/10W
12V/20W



● **G9**

Clear or Frosted
UV Stop Quartz
Double Protection Fuses
C Class 18W
C Class 28W
C Class 42W



● **PAR16, PAR20, PAR30, PAR38**

E27/E26 Cup
110V-240V

PAR16
C Class 40W

PAR20
C Class 40W

PAR30
C Class 40W
C Class 53W

PAR38
C Class 53W
C Class 70W
C Class 105W

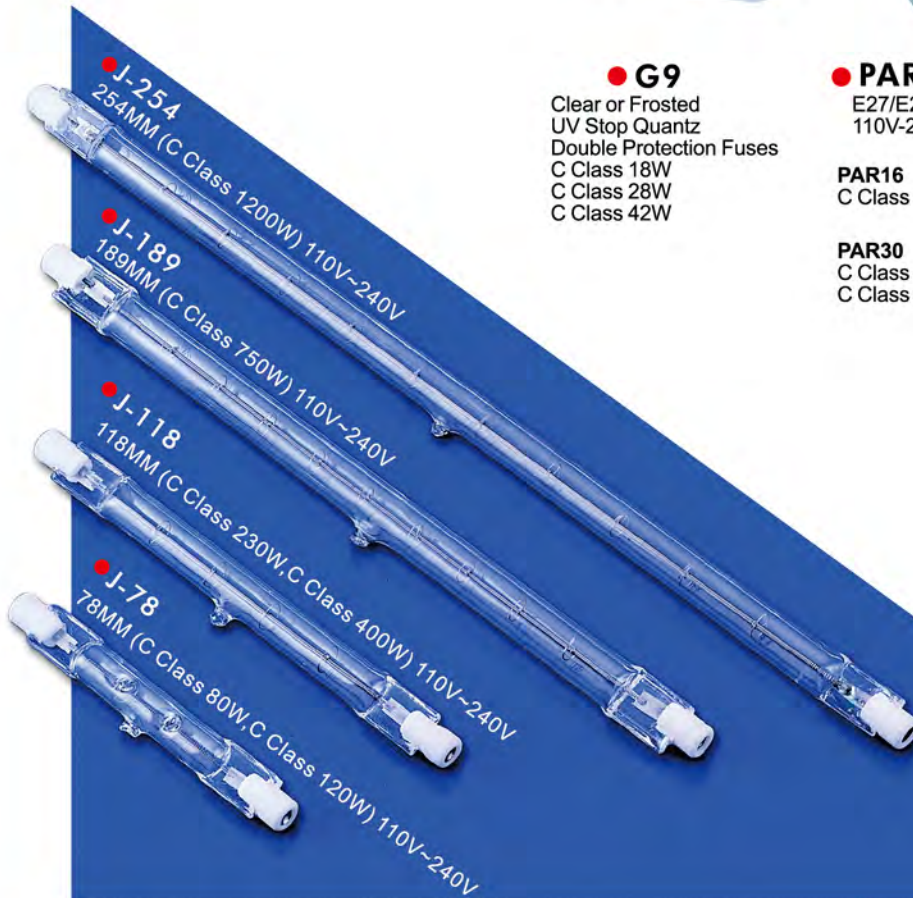

● **J-254**
254MM (C Class 1200W) 110V-240V

● **J-189**
189MM (C Class 750W) 110V-240V

● **J-118**
118MM (C Class 230W, C Class 400W) 110V-240V

● **J-78**
78MM (C Class 80W, C Class 120W) 110V-240V

T8 LED Tube

- Material: Aluminum + PC
- Input Voltage: 85V~265V
- Color Temperature: 2700-6500K
- CRI: Ra>70



● T8LD-A60
● T8LD-A12

● T8LD-B60
● T8LD-B12

Model No.	Size(mm)	No. of Leds	Watt	Luminous Flux(LM)
T8LD-A60	26 x 600	120pcs(SMD3528)	9W	750LM±5%
T8LD-A12	26 x 1200	240pcs(SMD3528)	17W	1500LM±5%
T8LD-A60	26 x 600	144pcs(SMD3528)	10W	1015LM±5%
T8LD-A12	26 x 1200	288pcs(SMD3528)	18W	2050LM±5%
T8LD-A60	26 x 600	96pcs(SMD3014)	10W	806LM±5%
T8LD-A12	26 x 1200	168pcs(SMD3014)	18W	1411LM±5%
T8LD-B60	26 x 600	48pcs(SMD2835)	10W	800LM±5%
T8LD-B12	26 x 1200	100pcs(SMD2835)	18W	1600LM±5%
T8LD-B60	26 x 600	108pcs(SMD3528)	10W	750LM±5%
T8LD-B12	26 x 1200	240pcs(SMD3528)	18W	1550LM±5%

Supply Partner

We are not only playing the role as a manufacturer but also can implement as a supply partner on your behalf which covers following functions:.

- Quality control ie quality assurance & conduct inspection.
- Shipping control ie consolidation of goods & shipment arrangement.
- Payment release
- Buying trip arrangement

We involve a comprehensive product range covering home lighting; commercial lighting, outdoor lightings, bulbs & tube lights.

if you are in consideration of having some one to act as your supply partner for above function , please don't hesitate to contact Home Resource for further discussion.



■ Service team



■ Inspection & Testing



■ Shipping & Financial

Sales Representative Wanted



R&D Personnel Wanted



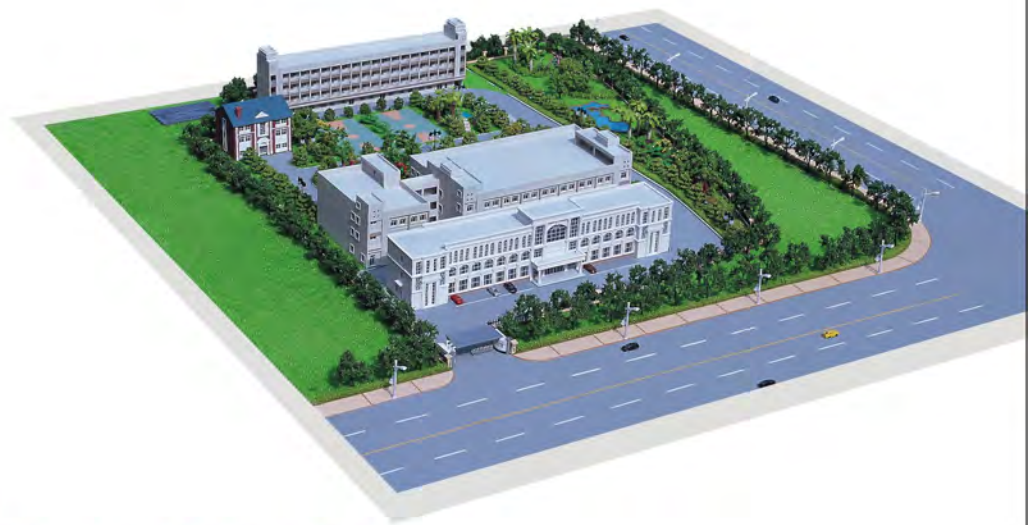

China New Factory (Zhongshan City, Guangdong Province)

Home Resource's products are designed and manufactured by its own factory (Green Resource) sited in Zhongshan, China.



Home Resource Ind. Co., Ltd.

The 19th Home Resource Prize Golf Invitation Tournament

To be held at Agile Golf & Country Club, ZhongShan, China

Expect your Participation



■ **Home Resource Golf Team**

Welcome Your Participation for a Friendly Golf Competition



Please call: 886-(0)2-2809-1212



Home Resource Industrial Co., Ltd.

4F, No. 69-5, Sec. 2, Chung Cheng East Rd., Tanshui Town 251, Taipei County, Taiwan

Tel : 886-2-2809-1212 (Rep. 12Lines) Fax : 886-2-2808-1565 , 2808-0190

E-mail : hr@homerresource.com.tw www.homerresource.com.tw

Factory : Home Resource Illumination Co., Ltd.

No. 8, Yanjiang W. 1st Rd., Keji Ave., Torch Development Zone, Zhongshan City,
Guangdong, China

廣東省中山市火炬開發區科技大道沿江西一路8號