

2017 LEDS THE WORLD

Let's Make Sweet Homes Together



www.homeresource.com.tw

28th anniversary



Our Vision

To illuminate every country of the world

Our Mission

- To be one of the leading lighting companies in Taiwan and China
 - To be the best at what customers value most
 - To exceed customers expectation
 - Treat staffs & customers & substructures as partnership
 - Enjoy work as part of life
-

Our Promise to Customer

- Quality assurance
 - Prompt delivery
 - Price competition
 - Excellent service
-

Our Core Competence

- Integrity
 - Passion
 - Innovation
 - Profession
 - Efficiency
 - Responsibility
 - Team Work
-

President's Message

Since its establishment in 1988, Home Resource Ind. Co. Ltd. has been Dedicated to production and Development Of lighting products for Two decades. We would like to take This opportunity to express our sincere Appreciation for your Fully supports and concerns over the past 28 years.



Sam Chen Ph.D

President of Home Resource

- Chairman of Taiwan Lighting Association: 2004~2007
- Director of CEECA and LABC
CEECA: The Central, Eastern Europe and CIS Association
LABC: Latin American Business Council
- Vice Chairman of Taiwan Investors Association in Zhongshan

With years of efforts on upgrading production capability and capacity, Home Resource has grown into a consummate manufacturer of lightings on O&M and ODM basis. Globally reputed R&D talent has also helped Home Resource to enhance popularity and recognition of its own-brand products in recent years.

In addition to existing branches, Home Resource has officially operated a newly constructed plant of 26,000 square meters in China (Zhong Shan City, Guangdong Province), which employs advanced production equipment to assure even shorter delivery and more considerate services for clients than before.

We strive for success not only in having determination and courage, but also developing innovative products and marketing intelligence base on our core competence: innovation, efficiency, integrity and passion. Home Resource will definitely get hold of past success to carry on growing continuously in the lighting territory now and then. Let's witness the brand new, prosperous Home Resource to achieve an even higher peak of success in the coming future.

Company Profile

Home Resource was established in 1988. Since then, the company has developed Into one of the most professional lighting manufactures in Taiwan and Mainland China.

Home Resource/Green Resource would like to express our sincere thanks to all customers, parts sub-contractors and every one of our employees. It is their continuing support and hard work that has allowed Home Resource/Green Resource to grow as rapidly as they have been able to. HR&GR will continue to make even greater efforts in the future.

Other than a self-support manufacturer, through a presence in Ningbo and Zhongshan and 50 employees, Home Resource also operates a sourcing network of two offices in China.

We strive to attain a position of long-term, sustainable pre-eminence in the lighting field "lighting up" both our customers and ourselves.

We look forward to working with you all continuously to create a brilliant future.



David Chen

General Manager

► Taipei Headquarter



► China Factory



► Sales Team



► Production Line



► China Show Room

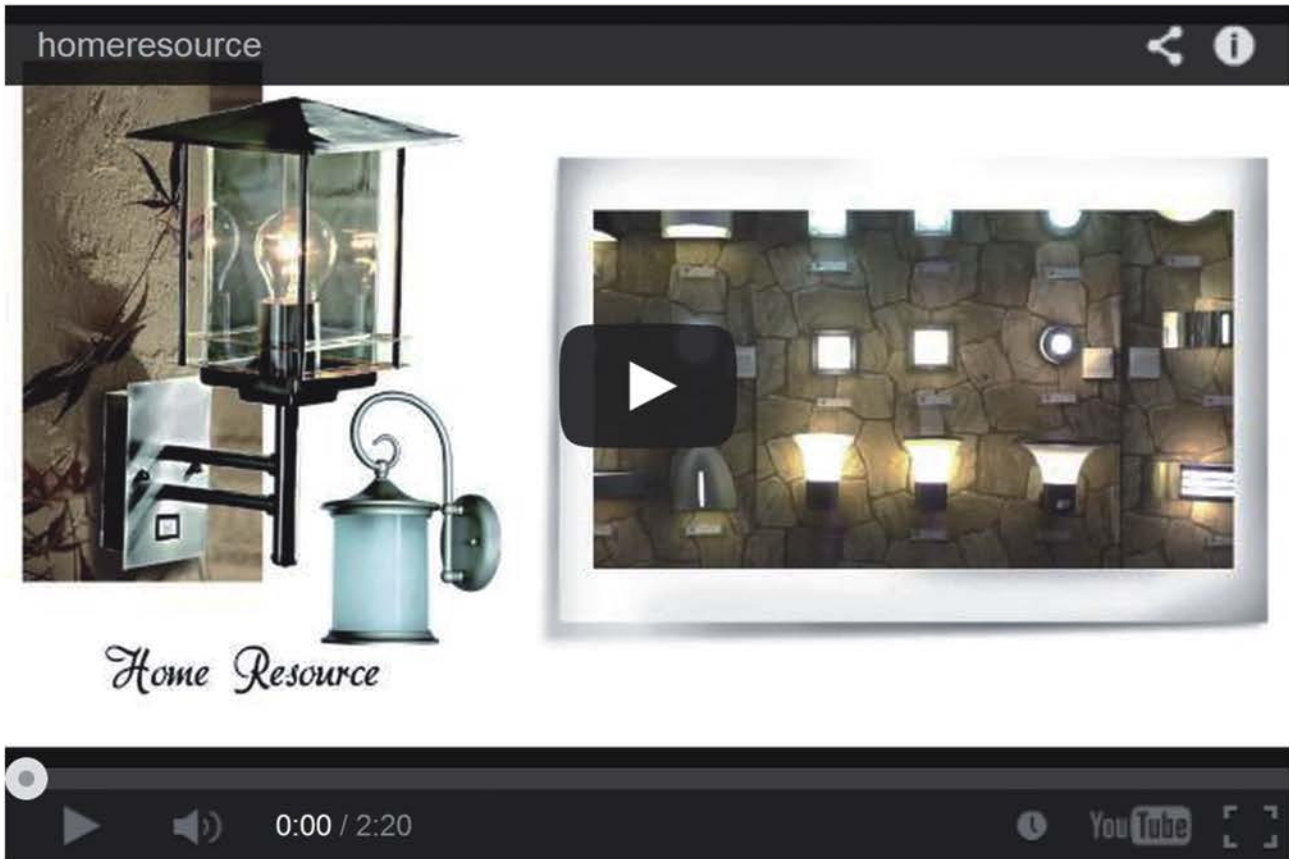

Exterior Wall Light



Exterior Garden Light



Stainless Steel Garden Light



Exterior Bulkheads



Interior Ceiling Light



LED Table Lamp



Novelty Light & Mood Light



In-ground Light & Deck Light

► **In-House Lab in our ZhongShan Factory**



Integrator Machine Set



Integrator Machine Set



Integrator Machine Set (To test Color Temperature, Luminous Flux, Ra ...)



Salt Spary Test Machine (To test Anti-corrosion status of metal material)



LCR Test Machine (To test Electrical resistance, Capacitance, Inductance)



Switching Power (To Adjust Voltage and Frequency when conducting aging test)



Instrument for Color Temperature Contrast



Lampholder Torsion Test Machine (Torsion test after the lampholder is assembled)



LED Aging Test Machine (Mainly use to test High Power LED)



LED Luminous Intensity Meter (To test the bright of LED)



IP Tester



Temperature Meter

HOME RESOURCE has received the following awards:

Design Awards:



■ Good Design Product of Taiwan



■ Red Dot Award of Germany



L: Sam Chen
(President of Home Resource Co.)

R: Alfred Albrecht, TUVPS
(GS Testing & Certification)

● Awarded from TUVPS as one of the Top 5 golden clients in Asia (2003)



L: Sam Chen
(President of Home Resource Co.)

R: P.K. Chiang
(Minister of Economic Department Taiwan)

● Being as Chairman of Taiwan Lighting Association in 2004



L: Jack Chen, Former President of HR/GR
R: Representative of Senior Group

● Award from Senior Group
Towards Annual Charity Donation

1. Red Dot Design Award: product design 2008, Germany
2. National Excellent Lighting Quality Award in Japan 1998, 2011 In 1995, HR being the 1st Taiwanese company in receipt of NEMKO, SEMKO, DEMKO, FI Certificates
3. Excellent Quality Award, Spain 1996
4. Awarded as one of the best "ISO 9001:2000" companies listed as members of KEMA organization in 1999, 2004 & 2010
5. National Quality Award in Taiwan in 2002, 2003, 2004, 2005, 2006 & 2014
6. The Most Popular Product Award in 2009 from Taiwan External Trade Development Council
7. Good Design Product, Taiwan, since 2008
8. The Best Innovation Award of Taiwan Lighting Association 1993, 1999, 2002, 2005, 2008, 2012 & 2015

➤ **Safety Approval:**
CE, GS, CUL, ETL



GS Certificate

CUL, ETL Certificate



CE Certificate

➤ **More than 60 patents...**





Home Resource

Manufacturer

&

Buying Agent

&

I

nspection
Agent

INDEX

Exterior Light

- ◆ Exterior Wall Light / Path Light / Hanging Light / Table Light / Floor Light P10-P59
- ◆ Exterior Spot Light P60-P70
- ◆ Exterior Lantern P71-P90
- ◆ Exterior Solar Light P91-P101
- ◆ Exterior Socket Outlet P102-P106
- ◆ Exterior Work Light / Flood Light P107-P123
- ◆ Exterior Ground Light & Deck Light P124-P128
- ◆ Exterior Bulkhead & Ceiling Light P129-P143
- ◆ Exterior Step Light P144-P146
- ◆ Exterior LED Tri Proof Light P147-P149

Interior Light

- ◆ Interior Decorative Light P150-P174
- ◆ Interior Mood Light & Novelty Light P175-P201
- ◆ Interior Plant Growth Light P202-P205
- ◆ Interior Wall / Reading Light & Table / Reading Light P206-P234
- ◆ Interior Spot Light P235-P252
- ◆ Interior Cabinet Light & Kitchen Light P253-P270
- ◆ Interior Picture Light & Display Light P271-P275
- ◆ Interior Bathroom Light P276-P284
- ◆ Interior Ceiling Light P285-P289
- ◆ Interior Panel Light / Down Light P290-P301

Miscellaneous

- ◆ Security Light P302-P307
- ◆ High Bay Light P308-P310
- ◆ Air Monitor Light P311-P313
- ◆ Sensor & Sensor Socket P314-P319
- ◆ Bulb & Tube P320-P328

Exterior Wall Light /
Path Light /
Hanging Light /
Table Light /
Floor Light

Home Resource 2017 Collection

LED Exterior Wall Light

- Material: Aluminum Body & Reflector + Glass Diffuser
- Lamp: 10W (2 x 5W COB LED)
- Voltage: 220V~240V
- Lumen: 420LM (4000K)
- Finish: Grey / Black / White
- IP54

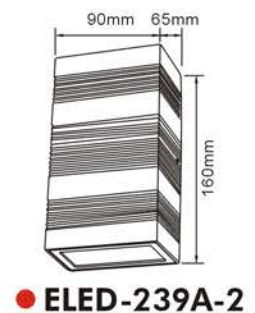
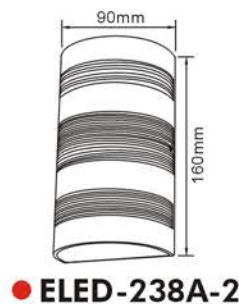

LED Exterior Wall Light

- Material: Aluminum Die-Casting Body + Opal PC Diffuser
- Voltage: 220V ~ 240V
- Finish: Black / White / Grey
- IP44



● **ELED-581**

Lamp: 12W (24 x 0.5W SMD2835 LED)
Lumen: 850LM (4000K)



● **ELED-582**

Lamp: 9W (45 x 0.2W SMD2835 LED)
Lumen: 650LM (4000K)



● **ELED-583**

Lamp: 5W (10 x 0.5W SMD2835 LED)
Lumen: 400LM (4000K)

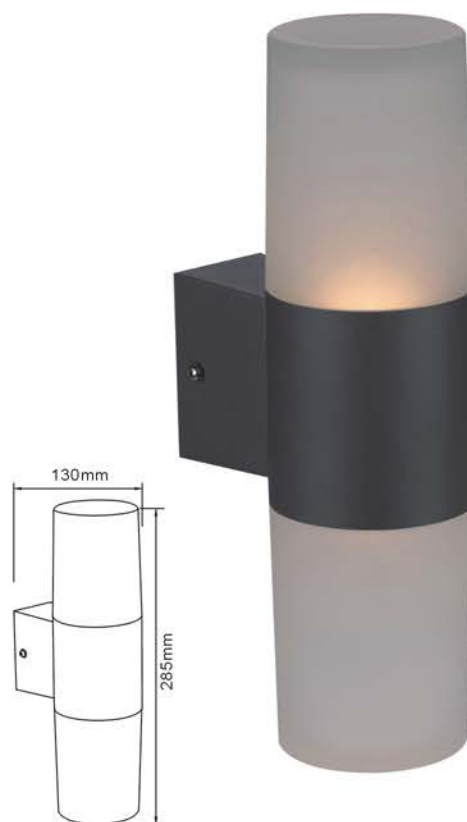

● **ELED-583-2**

Lamp: 10W (2 x 10 x 0.5W SMD2835 LED)
Lumen: 800LM (4000K)

LED Garden Wall/Path/Hanging Light

- Material: Aluminum Die-Casting Body + Opal Frosted PC Diffuser
- Lamp: 1 x COB 9W LED
- Color Temperature: 2700K~6500K
- Lumen: 600LM(4000K)
- Finish: Black Body + White Diffuser
- IP54

 eurofins

 CE EMC  RoHS



● ELED-568

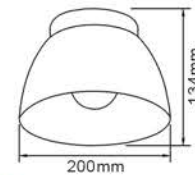

● CFLED-568

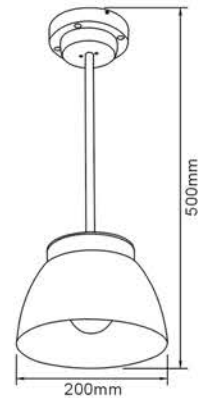

● HGLED-568

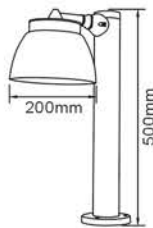

● GPLED-568(0.5M)

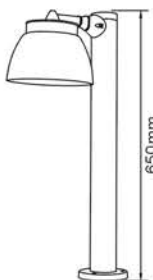

● GPLED-568(0.65M)



● GPLED-568(0.8M)



● GPLED-568(1M)



LED Exterior Wall Light

- Material: Aluminum Die-Casting Body + Glass or Opal Frosted PC Diffuser
- Color Temperature: 2700K~6500K
- Finish: Black / Dark Gray / Light Gray
- IP54

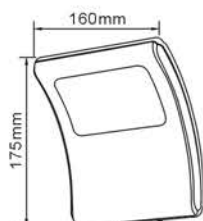

● **ELED-292**

With Opal Frosted PC Diffuser
Lumen: 480LM (3000K)

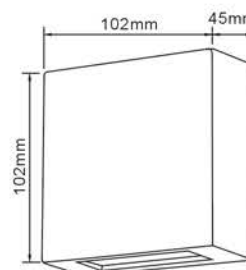

● **ELED-230**

With Glass Diffuser
Lamp: 1 x 3W LED
Lumen: 65LM (3000K)



● **ELED-230-2**

With Glass Diffuser
Lamp: 2 x 3W LED
Lumen: 105LM (3000K)

DOB (Driver On Board) Exterior LED Spot Light

- Material: PP
- Voltage: 80V ~ 265V
- Finish: Black
- IP44

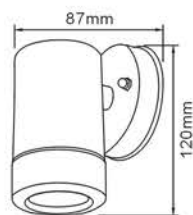

● ELED-403

Lamp: 3W (20 x SMD2835 LED)
Lumen: 115LM (3000K)

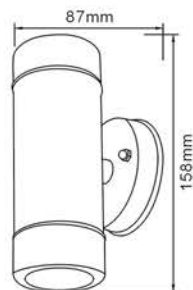

● ELED-403-2

Lamp: 2 x 3W (2 x 20 x SMD2835 LED)
Lumen: 300LM (3000K)



LED Garden Wall Light / Path Light

Glare-Free

- Material: Alu. Body + PC Diffuser
- Lamp: 5W COB LED
- Lumen: 350LM (4000K)
- Color Temperature: 2700K ~ 6500K
- CRI: Ra \geq 80
- Finish: Granulated Matt Black / Granulated Matt Grey / Granulated Matt White
- IP54

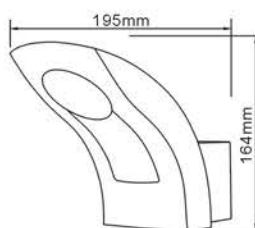

● **ELED-728**

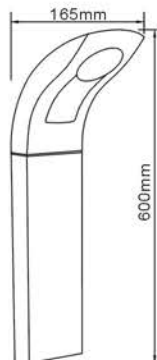
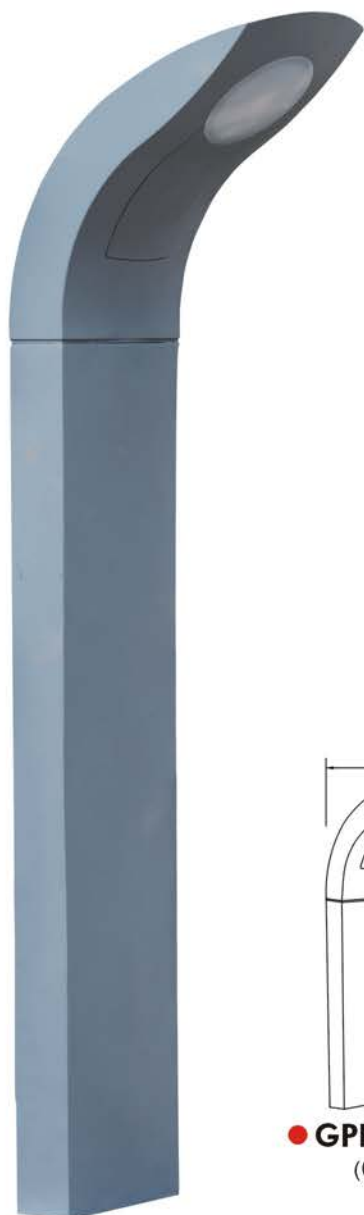

● **GPLED-728**
(0.6M)

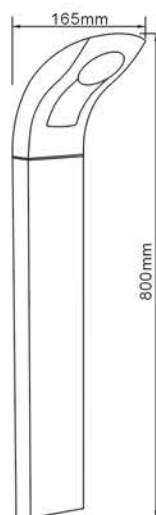

● **GPLED-728**
(0.8M)

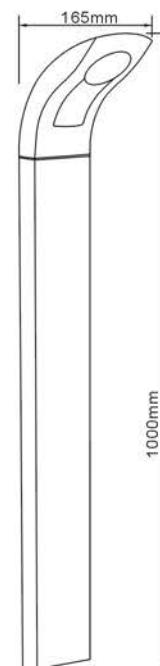

● **GPLED-728**
(1M)

LED Garden Wall Light - Door Plate Light Glare-Free

- Material: Alu. Body + PC Diffuser
- Lamp: 7.2W (6 x 1.2W SMD2835 LED)
- Lumen: 420LM (4000K)
- Color Temperature: 2700K ~ 6500K
- CRI: $Ra \geq 80$
- Finish: Granulated Matt Black / Granulated Matt Grey / Granulated Matt White
- IP54

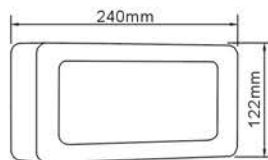

● ELED-729DPA



● ELED-729DP
Doorplate: Numbers 0~9 Incl.



LED Garden Wall Light / Path Light

Glare-Free

- Material: Alu. Body + PC Diffuser
- Lamp: 4.8W (4 x 1.2W SMD2835 LED)
- Lumen: 350LM (4000K)
- Color Temperature: 2700K ~ 6500K
- CRI: Ra \geq 80
- Finish: Granulated Matt Black / Granulated Matt Grey / Granulated Matt White
- IP54

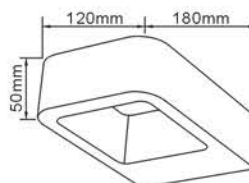

● **ELED-736**

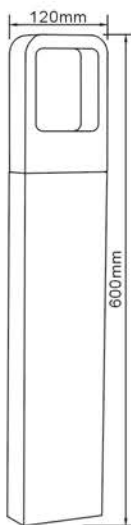

● **GPLED-736**
(0.6M)

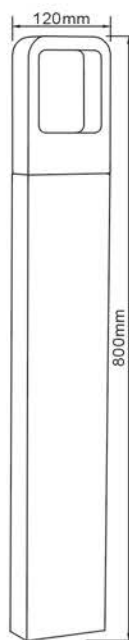

● **GPLED-736**
(0.8M)

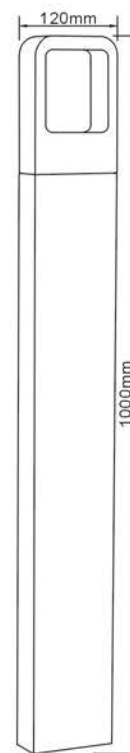

● **GPLED-736**
(1M)

LED Garden Wall Light / Path Light Glare-Free

- Material: Alu. Body + PC Diffuser
- Lamp: 7.2W (6 x 1.2W SMD2835 LED)
- Lumen: 480LM (4000K)
- Color Temperature: 2700K ~ 6500K
- CRI: Ra ≥ 80
- Finish: Granulated Matt Black / Granulated Matt Grey / Granulated Matt White
- IP54

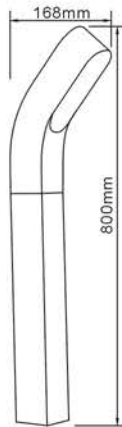

● **GPLED-713**
(0.6M)

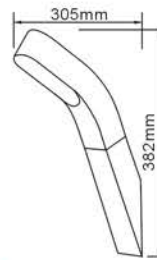

● **ELED-713W**

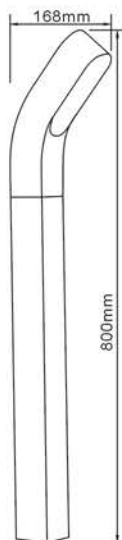

● **GPLED-713**
(0.8M)

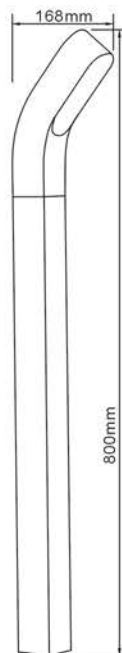

● **GPLED-713**
(1M)



LED Garden Wall Light/Path Light

- Material: Aluminum Body + PC & Glass Diffuser
- Voltage: 100V ~ 240V
- Color Temperature: 2700K ~ 6400K
- Finish: Granulated Matt Black
- IP44

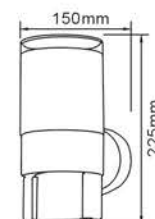

● **ELED-325**

Lamp: 12W (2 x 30 x 0.2W SMD2835 LED)
Lumen: 760LM (4000K)

●	Lamp	Lumen	Product size
GPLED-325(0.5M)	12W (2 x 30 x 0.2W SMD2835 LED)	715LM (4000K)	Dia. 11 x H.50cm
GPLED-325(0.8M)	12W (2 x 30 x 0.2W SMD2835 LED)	580LM (4000K)	Dia. 11 x H.80cm

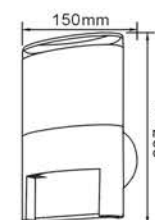

● **ELED-325A**

Lamp: 12W (2 x 30 x 0.2W SMD2835 LED)
Lumen: 680LM (4000K)

●	Lamp	Lumen	Product size
GPLED-325A(0.5M)	12W (2 x 30 x 0.2W SMD2835 LED)	775LM (4000K)	L: 16 x W: 7.5 x H: 50cm
GPLED-325A(0.8M)	12W (2 x 30 x 0.2W SMD2835 LED)	650LM (4000K)	L: 16 x W: 7.5 x H: 80cm

LED Garden Wall Light/Path Light

- Material: Aluminum Body + PC & Glass Diffuser
- Voltage: 100V ~ 240V
- Lamp: 12W (Top 6W: 30 x 0.2W SMD2835 LED + Bottom 6W: COB 6W LED)
- Color Temperature: 2700K ~ 6400K
- Finish: Granulated Matt Black
- IP44

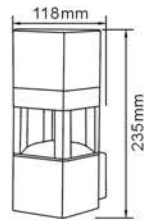

● **ELED-326**
Lumen: 660LM (4000K)

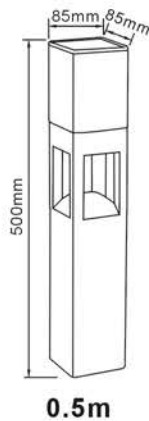

0.5m

●	Lumen	Product size
GPLED-326A(0.5M)	630LM (4000K)	L: 8.5 x W: 8.5 x H: 50cm
GPLED-326A(0.8M)	580LM (4000K)	L: 8.5 x W: 8.5 x H: 80cm

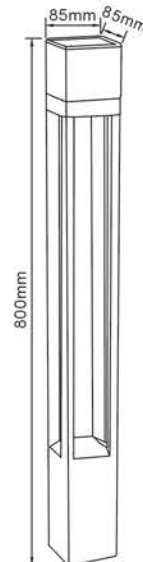

0.8m

●	Lumen	Product size
GPLED-326(0.5M)	720LM (4000K)	L: 8.5 x W: 8.5 x H: 50cm
GPLED-326(0.8M)	690LM (4000K)	L: 8.5 x W: 8.5 x H: 80cm



LED Garden Wall Light / Path Light

- Material: Aluminum Body + PC Diffuser
- Voltage: 100V ~ 240V
- Lamp: 9.6W (48 x 0.2W SMD2835 LED)
- Color Temperature: 2700K ~ 6400K
- Finish: Granulated Matt Black
- IP44

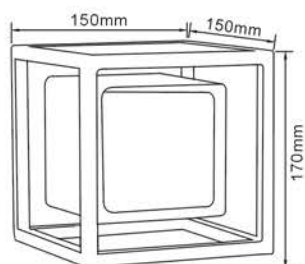

● **ELED-186**
Lumen: 510LM (4000K)

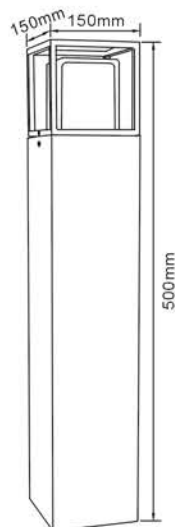

● **GPLED-186(0.5M)**

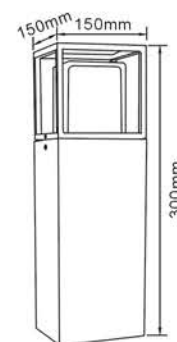

● **GPLED-186(0.3M)**

●	Lumen	Product size
GPLED-186(0.3M)	440LM (4000K)	L. 15 x W. 15 x H. 30cm
GPLED-186(0.5M)	415LM (4000K)	L. 15 x W. 15 x H. 50cm
GPLED-186(0.8M)	350LM (4000K)	L. 15 x W. 15 x H. 80cm
GPLED-186(1M)	300LM (4000K)	L. 15 x W. 15 x H. 100cm

LED Garden Wall Light

- Material: Aluminum Body + PC Diffuser
- Voltage: 100V ~ 240V
- Lamp: 12W (60 x 0.2W SMD2835 LED)
- Color Temperature: 2700K ~ 6400K
- Finish: Granulated Matt Black
- IP44

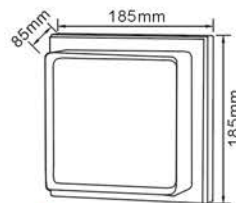

● **ELED-190**

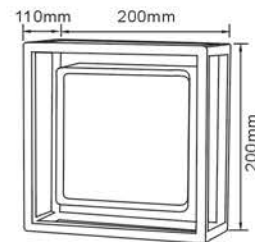

● **ELED-190A**

●	Lumen	Product size
ELED-190	560LM (4000K)	L. 18.5 x W. 18.5 x H. 8.5cm
ELED-190A	480LM (4000K)	L. 20 x W. 20 x H. 11cm

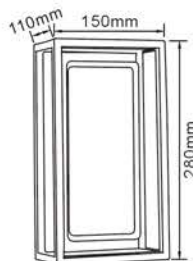

● **ELED-191A**

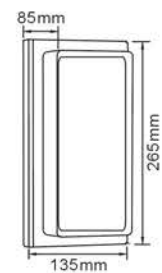

● **ELED-191**

●	Lumen	Product size
ELED-191	560LM (4000K)	L. 13.5 x W. 26.5 x H. 8.5cm
ELED-191A	500LM (4000K)	L. 15 x W. 28 x H. 11cm

LED Garden Wall Light/Path Light

- Material: Aluminum Body + Glass Diffuser
- Voltage: 100V ~ 240V
- Color Temperature: 2700K ~ 6400K
- Finish: Granulated Matt Black / Granulated Matt Gray
- IP44

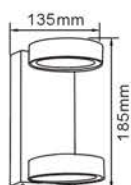

● **ELED-327A-2**

Lamp: 10W (2 x COB 5W LED)
Lumen: 820LM (4000K)

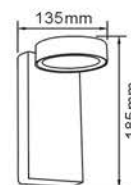

● **ELED-327**

Lamp: 10W (COB 10W LED)
Lumen: 800LM (4000K)

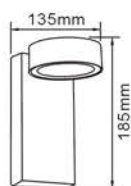

● **ELED-327-2**

Lamp: 10W (2 x COB 5W LED)
Lumen: 800LM (4000K)

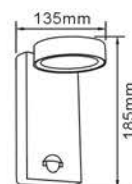

● **ELED-327S**

Lamp: 10W (COB 10W LED)
Lumen: 800LM (4000K)
Sensor: 8M, 120°

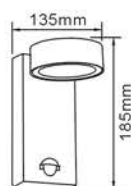

● **ELED-327S-2**

Lamp: 10W (2 x COB 5W LED)
Lumen: 800LM (4000K)
Sensor: 8M, 120°

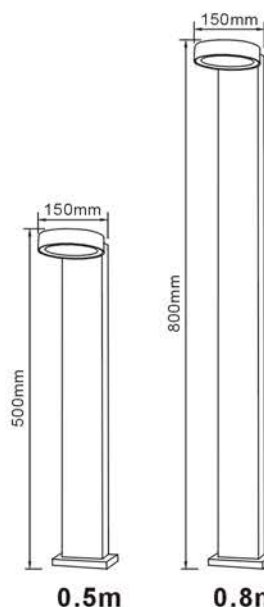

●	Lamp	Lumen	Product size
GPLED-327(0.5M)	10W (COB 10W LED)	740LM (4000K)	L: 15 x W: 10.2 x H: 50cm
GPLED-327(0.8M)	10W (COB 10W LED)	660LM (4000K)	L: 15 x W: 10.2 x H: 80cm

LED Garden Wall Light/Path Light

- Material: Aluminum Body + PC Diffuser
- Voltage: 100V ~ 240V
- Lamp: 12W (60 x 0.2W SMD2835 LED)
- Color Temperature: 2700K ~ 6400K
- Finish: Granulated Matt Black
- IP44

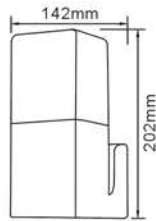

● **ELED-328UP**
Lumen: 680LM (4000K)

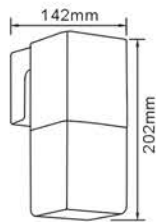

● **ELED-328DN**
Lumen: 680LM (4000K)

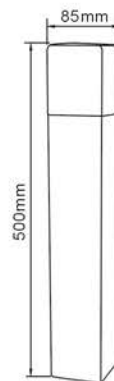

0.5m

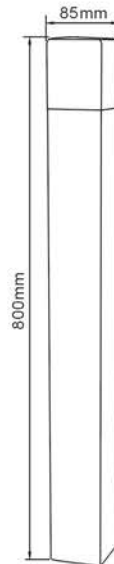

0.8m



●	Lumen	Product size
GPLED-328(0.5M)	680LM(4000K)	L: 8.5 x W: 8.5 x H: 50cm
GPLED-328(0.8M)	600LM(4000K)	L: 8.5 x W: 8.5 x H: 80cm

LED Exterior Wall Light

- Material: Aluminum Body + PC Diffuser
- Voltage: 100V ~ 240V
- Color Temperature: 2700K ~ 6400K
- Finish: Granulated Matt Black / Granulated Matt Grey
- IP44

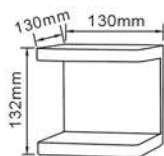

● **ELED-282-2**

Lamp: 12W (2 x 30 x 0.2W SMD2835 LED)
Lumen: 925LM (4000K)

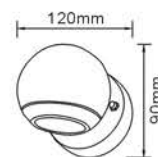

● **ELED-343**

Aluminum Body + Glass Diffuser
Lamp: 3W (30 x 0.1W SMD2835 LED)
Lumen: 300LM (4000K)
220V ~ 240V

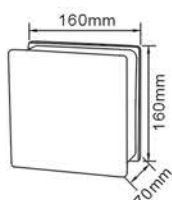

● **ELED-284**

Lamp: 12W (4 x 15 x 0.2W SMD2835 LED)
Lumen: 520LM (4000K)

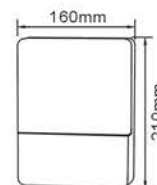

● **ELED-264**

Lamp: 9.6W (48 x 0.2W SMD2835 LED)
Lumen: 470LM (4000K)

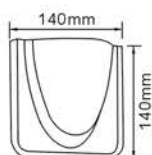

● **ELED-287**

Aluminum Body + Glass Diffuser
Lamp: COB 6W LED
Lumen: 460LM (4000K)

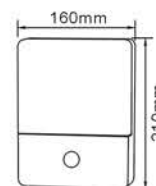

● **ELED-264S**

Lamp: 9.6W (48 x 0.2W SMD2835 LED)
Lumen: 470LM (4000K)
Sensor: 8M, 120°

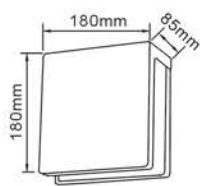

● **ELED-291**

Lamp: 9W (3 x 15 x 0.2W SMD2835 LED)
Lumen: 270LM (4000K)

LED Garden Wall Light/Path Light

- Material: Aluminum Body + Glass Diffuser
- Voltage: 100V ~ 240V
- Lamp: 9W (45pcs x 0.2W SMD2835 LED)
- Color Temperature: 2700K ~ 6400K
- Lumen: 695LM (4000K)
- IP54

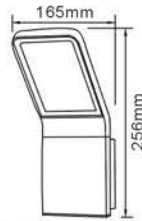

● **ELED-285**

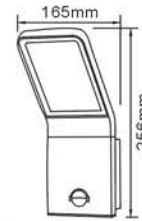

● **ELED-285S**
With Sensor (8M, 120°)

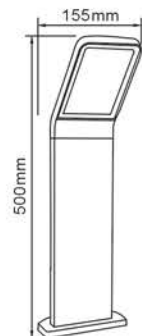

● **GPLED-285(0.5M)**

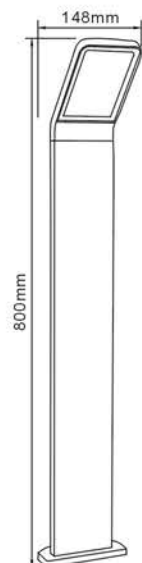

● **GPLED-285(0.8M)**

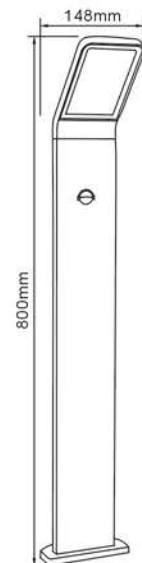

● **GPLED-285S(0.8M)**
With Sensor (8M, 120°)

Exterior Lantern

- Material: Stainless Steel + PC
- Voltage: 220~240V
- Lamp: E27 / Max 40W A60 bulb or 23W ESB spiral (Bulb Excl.)
- Finish: Stainless Steel + White
- IP44



● **GPL-762**
0.9M

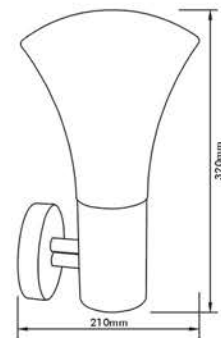

● **EL-762**

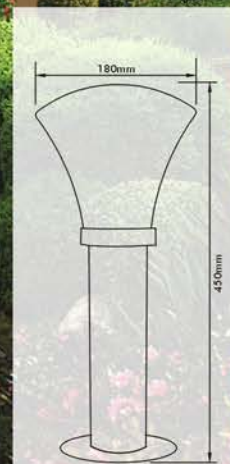

● **GPL-762**
0.45M

IP65 Garden Table Lamp/ Floor Lamp

- Material: PE shade + ABS bottom cover + Aluminum tube & base
- Voltage: 220~240V 50Hz
- Lamp: E27 Max 16W LED Bulb (Bulb Excl.)
- With 2M 2 x 1.0mm² H05RN-F VDE rubber cable and IP44 VDE plug
- Finish: White shade + Silver painting tube & base
- IP65



Energy Saving Garden Wall Light/ Path Light

- Material: Aluminum + PC Diffuser
- Bulb Adaptable: E27 6W LED Bulb
- Input Voltage: 220~240V
- Finish: Gray/Dark Gray/Black
- IP54

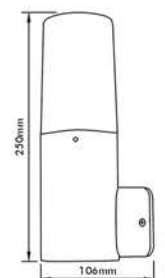

● **WG-857**

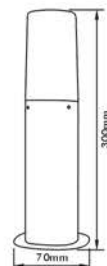

● **GPL-857**
(0.3M)



● **GPL-857**
(0.5M)

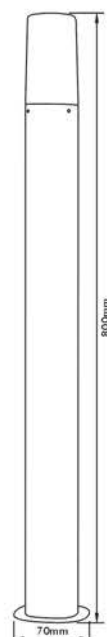

● **GPL-857**
(0.8M)



LED Garden Wall Light/Path Light

- Material: Aluminum + PC Diffuser
- With 6W (12 x 0.5W LED)
- Input Voltage: 220~240V
- Finish: Gray/Dark Gray/Black
- IP54

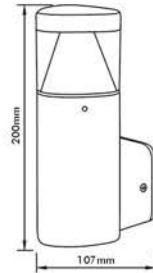

● **ELED-164**

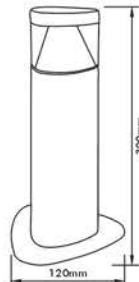

● **GPLED-164**
(0.3M)



● **GPLED-164**
(0.8M)



● **GPLED-164**
(0.5M)

LED Garden Wall Light/Path Light

- Material: Aluminum + PC Diffuser
- With 6W (12 x 0.5W LED)
- Input Voltage: 220~240V
- Finish: Gray/Dark Gray/Black
- IP54

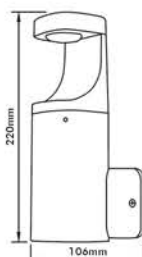

● **ELED-859**

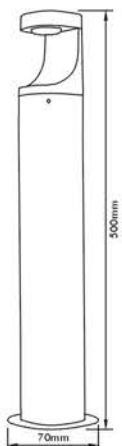

● **GPLED-859**
(0.5M)

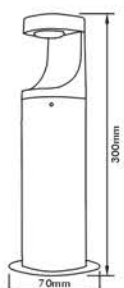

● **GPLED-859**
(0.3M)

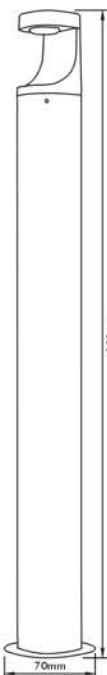

● **GPLED-859**
(0.8M)



LED Garden Path Light

- Material: Aluminum body + PC Diffuser
- Lamp: 5.4W (90 x 0.06W LED)
- Luminous Flux: 2700K 585LM/5400K 675LM
- Finish: Dark Gray/Black
- IP54

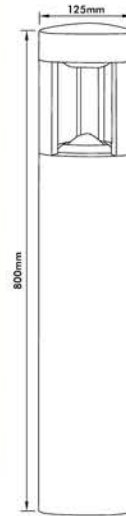
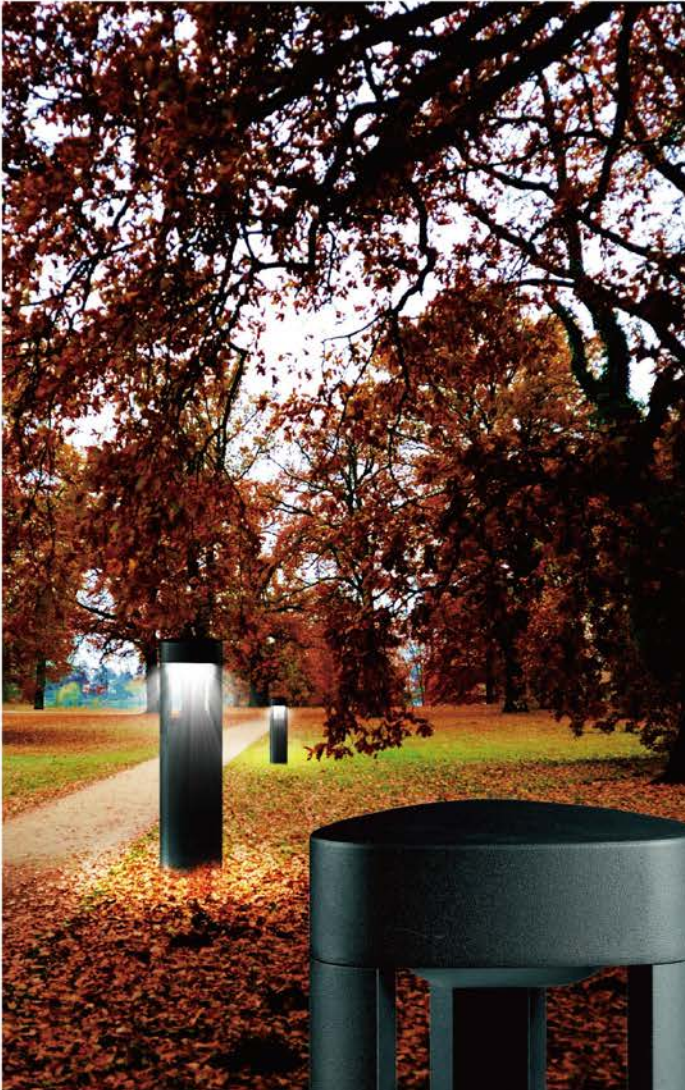

● GPLED-156

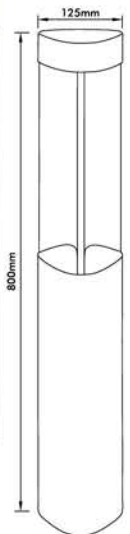

● GPLED-162

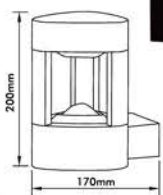
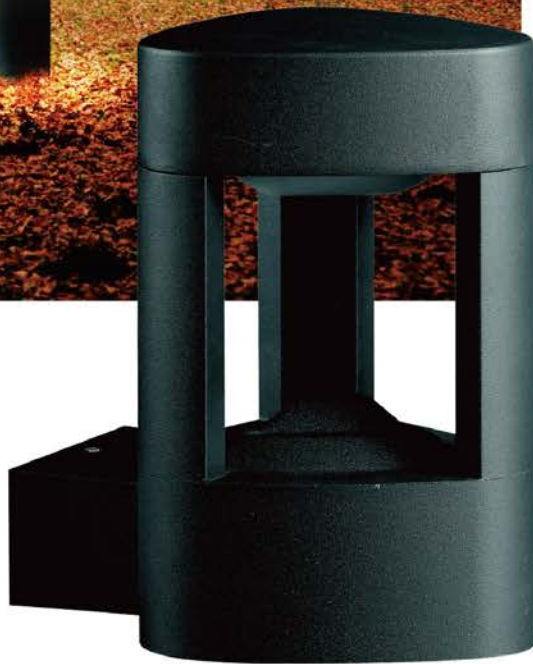

● ELED-156

LED Garden Wall Light

- Material: Aluminum body + PC Diffuser
- Lamp: 5.4W (90 x 0.06W LED)
- Luminous Flux: 2700K 585LM/5400K 675LM
- Finish: Dark Gray/Black
- IP54

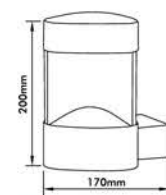

● ELED-162



Exterior Lantern

- Material: Die Cast Aluminum + Frosted PC
- Bulb Adaptable: E27 10W LED Bulb A type 
- Finish: White/Black/Matt Rust

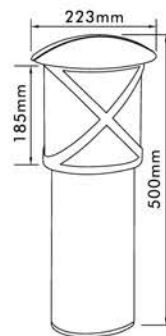

● **EL-341PE2**
IP44

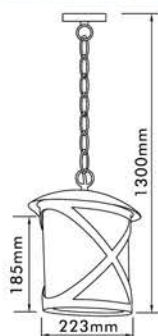

● **EL-341HG**
IP23

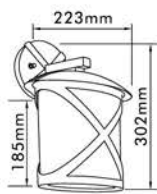

● **EL-341DN**
IP23

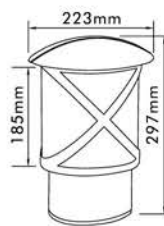

● **EL-341P2**
IP44



LED Garden Path Light

- Material: Stainless Steel + Clear PC
- Color: Stainless Steel
- Lamp: 6W (30 x 0.2W LED)
- Input Voltage: 100-240V
- IP44

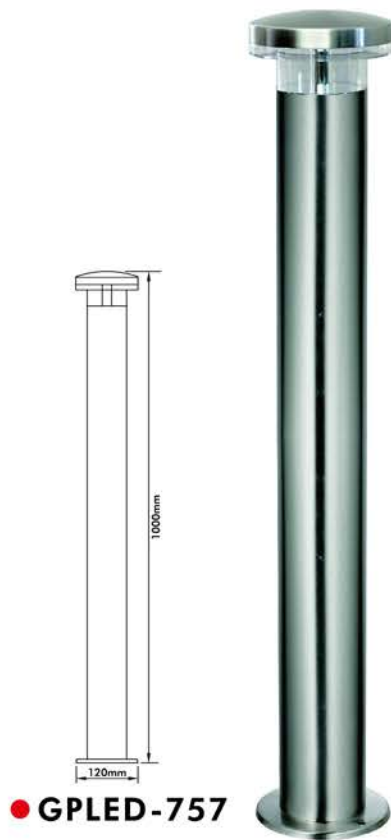

LED Garden Wall Light

- Material: Stainless Steel + Clear PC
- Color: Stainless Steel
- Lamp: 6W (30 x 0.2W LED)
- Input Voltage: 100-240V
- IP44

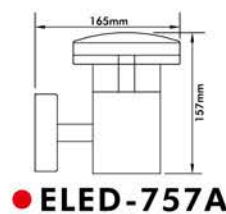



Garden Wall Light

- Material: Iron + Glass
- Bulb Adaptable: E27 10W LED Bulb A type 
- Finish: Black
- IP44

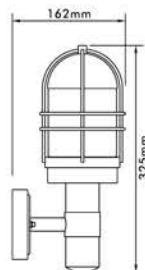

● EL-226UP

Garden Path Light

- Material: Iron + Glass
- Bulb Adaptable: E27 10W LED Bulb A type 
- Finish: Black
- IP44

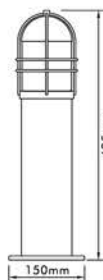

● GPL-226
H: 495mm

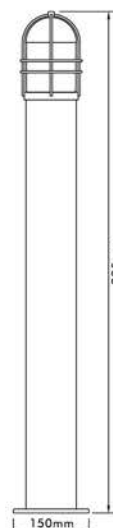

● GPL-226
H: 995mm

Exterior Lantern

- Material : Stainless Steel + Glass
- Bulb Adaptable: E27 10W LED Bulb A type 
- IP44

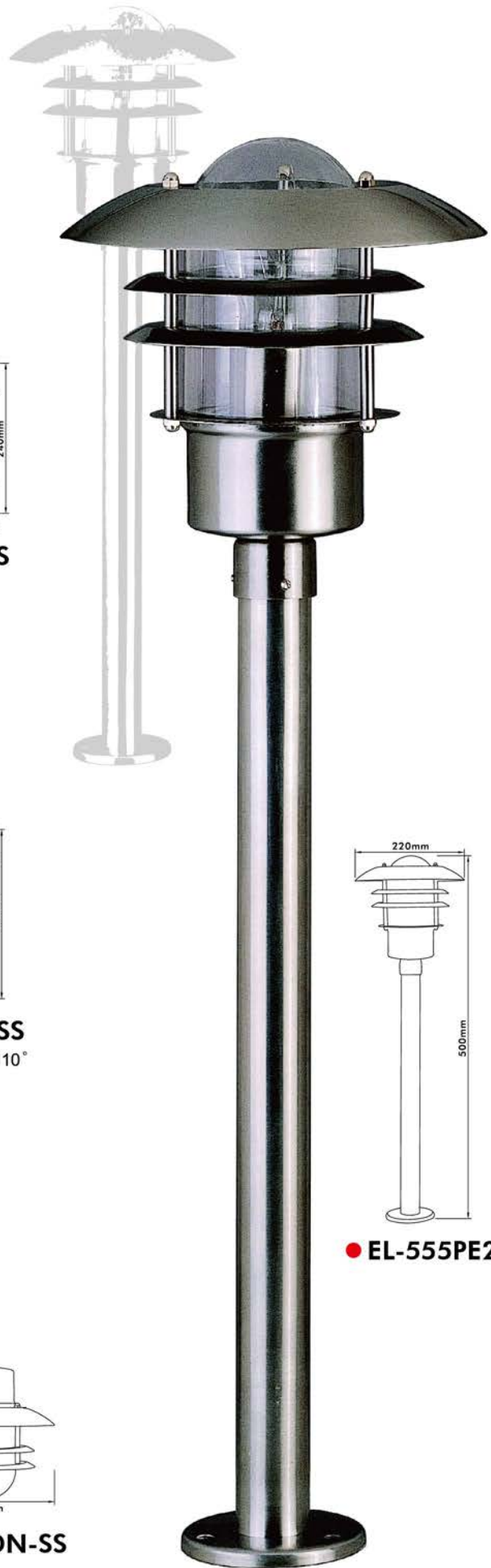
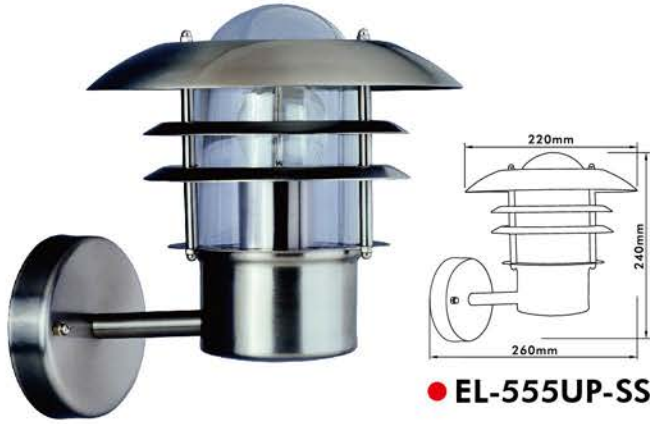

Exterior Lantern-Exito

- Material: Iron + Glass
- Bulb Adaptable: E27 10W LED Bulb A type
- Finish: Galvanized Iron/White/ Black
- IP44

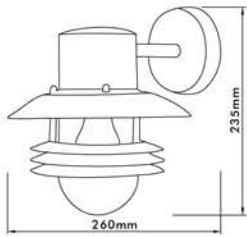

● EL-555DN1

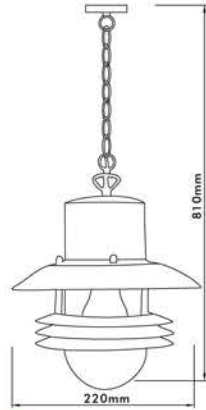

● EL-555HG
Painting Only

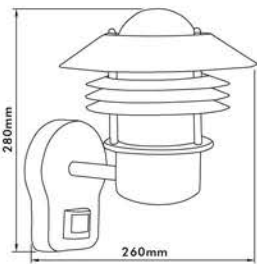

● EL-555UPS
Sensor Range: 10M x 110°

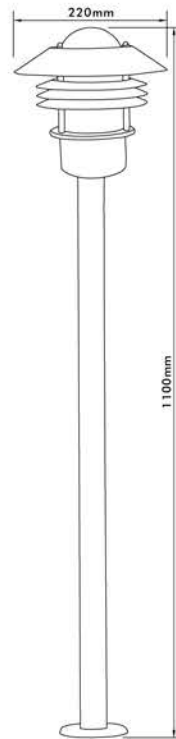

● EL-555PE2

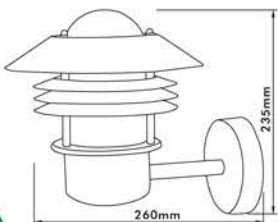

● EL-555UP



Stainless Steel Garden Wall / Path Light

- Material: Stainless Steel + PC Diffuser
- Bulb Adaptable: E27 10W LED Bulb A type 
- Finish: Stainless Steel
- IP44

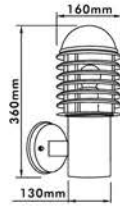

● GPL-SS01/UP

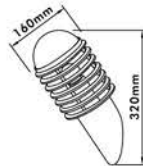

● GPL-SS01/W

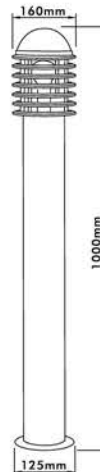

● GPL-SS01



Aluminum Garden Path Light

- Material: Die Cast Aluminum + PC
- Bulb Adaptable: E27 10W LED Bulb A type 
- Finish: Black
- IP44

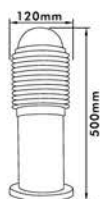

● GPL-01 (0.5M)

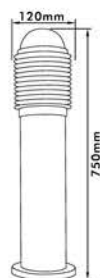

● GPL-01 (0.75M)

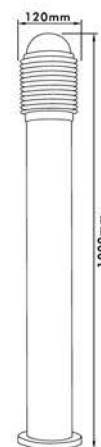

● GPL-01 (1M)



Garden Wall/Path Light-Steel Version

- Material: Iron + Clear PC Shade
- Bulb Adaptable: E27 10W LED Bulb A type
- Finish: Matt Black
- IP44



• EL-SS05UP



• EL-SS05UPS



• GPL-SS05

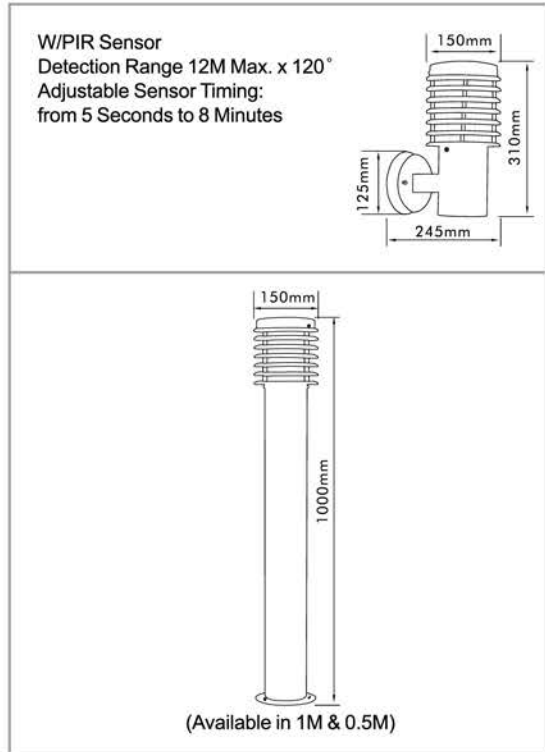

Garden Wall/Path Light-Stainless Steel Version

- Material: Brushed Stainless Steel + Clear PC Shade
- Bulb Adaptable: E27 10W LED Bulb A type
- Finish: Stainless Steel
- IP44



• EL-SS05UP-SS



• EL-SS05UPS-SS



• GPL-SS05-SS

LED Garden Wall Light

- Material: Aluminum + PC
- Lamp: 10W (20 x 0.5W LED)
- Color: Dark Gray / Gray
- Input Voltage: 220~240V
- IP44
- Ra:>80

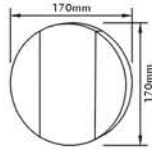

● **ELED-172**
Without Sensor

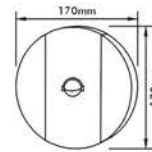

● **ELED-172S**
With Sensor

Detection Range: 90° , Max. 8M
Duration Time: 10+/-5 Secs ~ 4+/-1 Mins (adjustable)



LED Garden Wall Light

- Material: Aluminum + PC
- Lamp: 10W (20 x 0.5W LED)
- Color: Dark Gray / Gray
- Input Voltage: 220~240V
- IP44
- Ra:>80

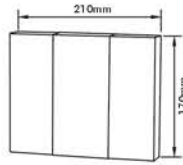

● **ELED-173**
Without Sensor

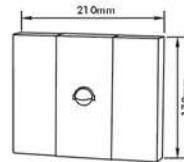

● **ELED-173S**
With Sensor

Detection Range: 90° , Max. 8M
Duration Time: 10+/-5 Secs ~ 4+/-1 Mins (adjustable)



Garden Wall Light

- Material: Aluminum + Glass
- Color: Black / Grey
- Input Voltage: 220~240V
- IP44
- Ra \geq 75



● EL-233-2

Lamp: 2 x G9 5W LED bulb

● ELED-233-2

Lamp: 5.6W (28ps x 0.2W SMD 5050 LED)

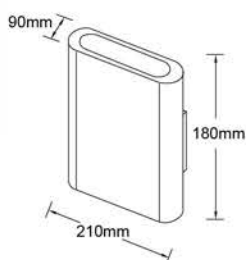

● ELED-234

Lamp: 4W (20ps x 0.2W SMD 5050 LED)

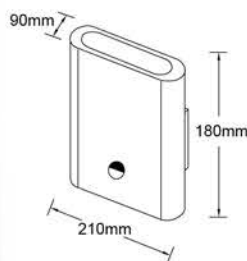

● ELED-234S

Lamp: 4W (20ps x 0.2W SMD 5050 LED)
Sensor: 120° ; 8M Max. ; 10 Secs ~ 5 Mins



Garden Wall Light

- Input Voltage: 220~240V
- IP44
- Ra \geq 75

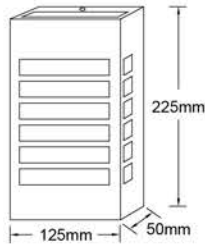

● ELED-235

Material: Stainless Steel cover + Aluminum back plate + PC diffuser
Color: Black Painting / Grey Painting / Stainless Steel finish
Lamp: 6W (30ps x 0.2W SMD 5050 LED)

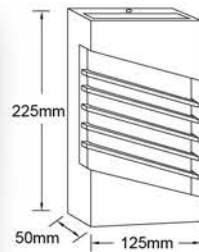

● ELED-236

Material: Aluminum + PC
Color: Black Painting / Grey Painting
Lamp: 6W (30ps x 0.2W SMD 5050 LED)

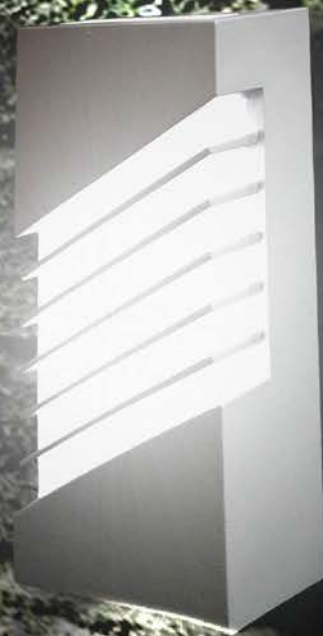

Garden Wall Light

Finish: Polished Alum
IP44



● **ELED-242**
Aluminum Die Cast + PC
2.4W (12 x 0.2W LED)

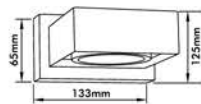

● **ELED-243**
Aluminum Die Cast + PC
2.4W (12 x 0.2W LED)

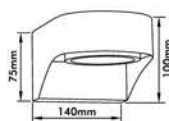

● **EL-119**
Aluminum Die Cast + Glass
2 x G9 5W LED bulb

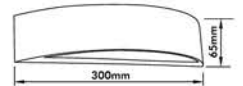

● **ELED-119**
Aluminum Die Cast + Glass
1.8W (30 x 0.06W LED)



● **EL-240**
Aluminum Die Cast + Glass
2 x G9 5W LED bulb

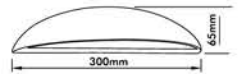

● **EL-241**
Aluminum Die Cast + Glass
Bulb Adaptable: E27 G45 5W LED Bulb

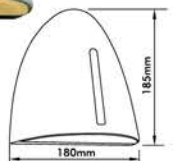

● **EL-118**
Aluminum Die Cast + Glass
G9 5W LED bulb

● **ELED-118**
Aluminum Die Cast + Glass
1W (18 x 0.06W LED)

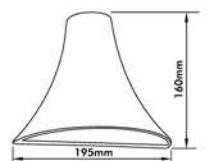

2 in 1 LED Under Water Light/ LED Garden Spot Light

- Material: Solid Alu. Body
- Lamp: 1W&3W LED (6000K/Cool White)
- Finish: Aluminum Anodize
- IP68



● GLED-36BA/SP

1W	3W
6000K	6000K
80Lm	220Lm
Build-in Driver	Build-in Driver



- Option 1
- **GLED-36BA**
2.5M H05RN-F Cable
IP68 VDE Plug



- Option 2
- **GLED-36SP**
2.5M H05RN-F Cable
IP68 VDE Plug

2 in 1 LED Under Water Light/ LED Garden Spot Light

- Material: Solid Alu. Body
- Lamp: 1W LED (6000K/Cool White) x 3pcs
- Finish: Aluminum Anodize
- IP68

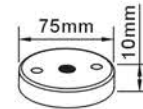
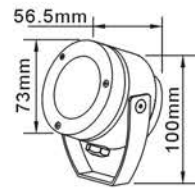

● GLED-311BA/SP

3 x 1W = 3W
6000K: 210Lm
Build-in Driver



Option 1

● GLED-311BA

2.5M H05RN-F Cable



Option 2

● GLED-311SP

2.5M H05RN-F Cable



Exterior Lantern

- Material : Stainless Steel + PC
- Bulb Adaptable: E27 10W LED Bulb
- Finish: Stainless Steel
- IP44

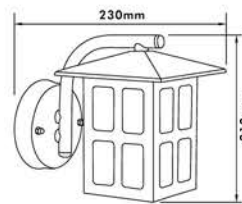
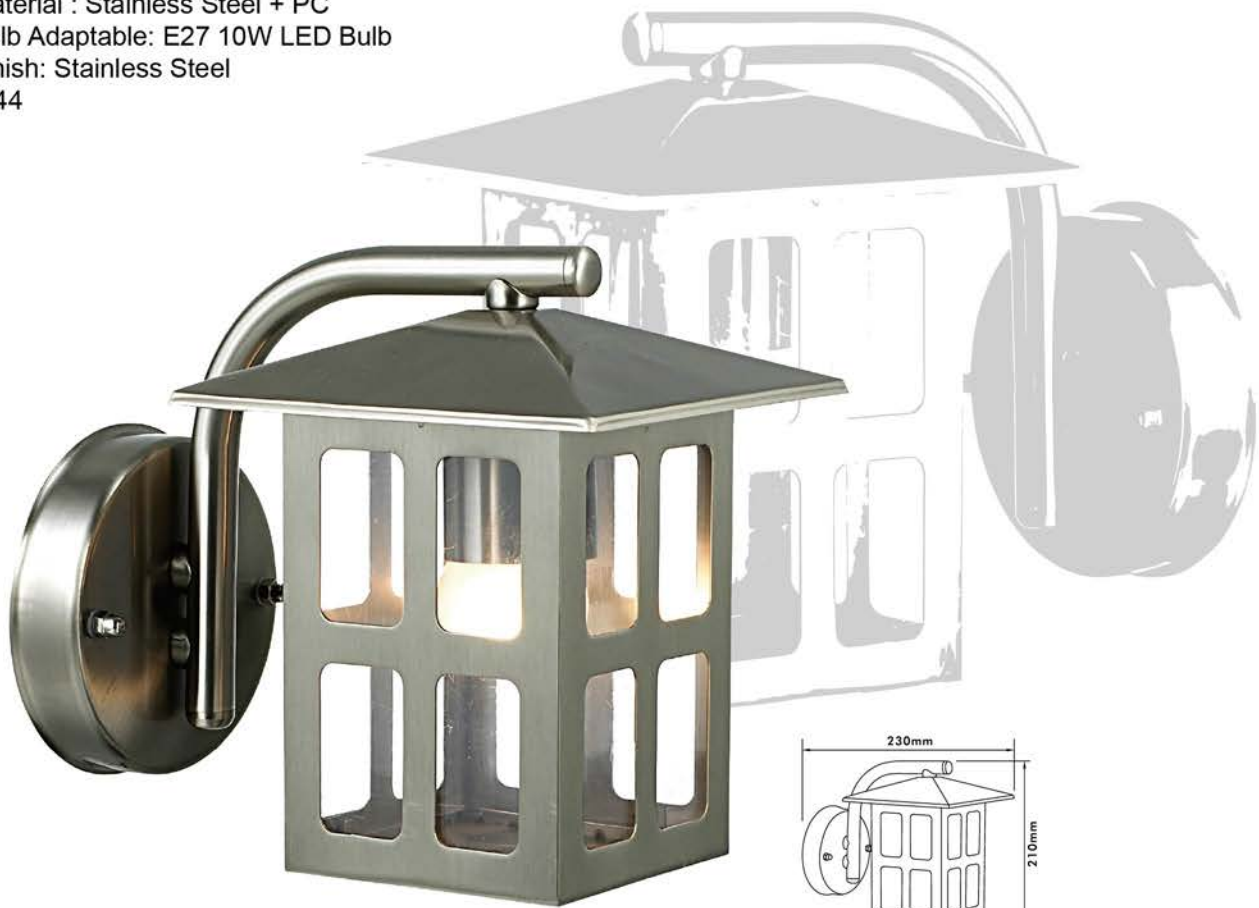

● EL-932DN-B

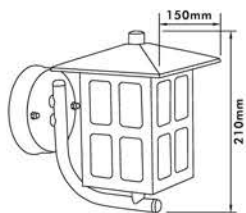

● EL-932UP-B

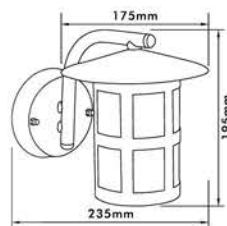

● EL-932DN-A





Exterior Lantern

- Material: Iron + Clear Glass
- Bulb Adaptable: E27 10W LED Bulb A type 
- Finish: Black/White/Galvanized
- IP44

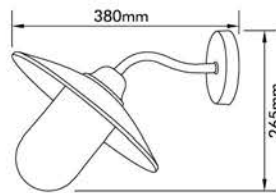

● ● EL-991DN



Exterior Lantern

- Material: Iron + PC/Black
- Bulb Adaptable: E27 10W LED Bulb
- Finish: Black
- IP23

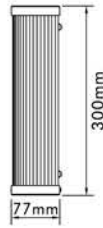

● EL-063HF



Exterior Lantern

- Material: Iron + PC
- Bulb Adaptable: E27 10W LED Bulb
- Finish: Metallic Grey
- IP44

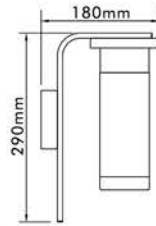

● EL-824DN



Exterior Lantern

- Material: Iron + Glass
- Bulb Adaptable: E27 10W LED Bulb A type 
- Finish: Antique Brushed
- IP44

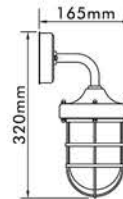

● EL-825DN



Exterior Lantern

- Material: Iron + Glass/
- Bulb Adaptable: E27 10W LED Bulb A type 
- Finish: Black
- IP44

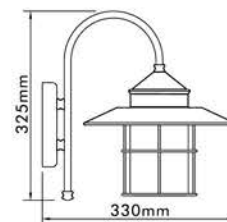

● EL-641DN3

Exterior Lantern

- Material: Stainless Steel
- Bulb Adaptable: E27 10W LED Bulb 
- IP44



● EL-271UP



Exterior Lantern

- Material: Iron + Bubble Glass
- Bulb Adaptable: E27 10W LED Bulb A type
- Finish: Red Antique Brass/Black
- IP23



● EL-199DN

Garden Wall Light

- Bulb Adaptable: E27 10WLED Bulb 
- Voltage: 220V~240V
- Finish: Stainless Steel + White
- IP44

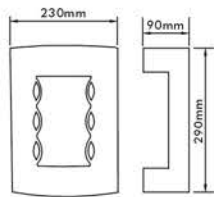

● **EL-777**

Stainless Steel Body + PC Diffuser

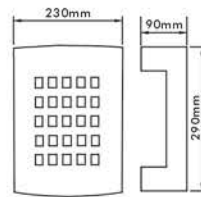

● **EL-778**

Stainless Steel Body + PC Diffuser

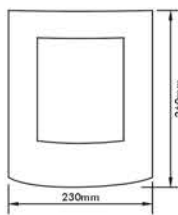

● **EL-763**

Stainless Steel Body + PP Diffuser

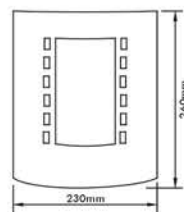

● **EL-772**

Stainless Steel Body + PP Diffuser



Exterior Wall Lamp

- Material: Aluminum Cover + PP Body
- Bulb Adaptable: E27 10W LED Bulb A type 
- Finish: Granulated Matt Silver Grey / Granulated Matt Dark Grey
- IP44

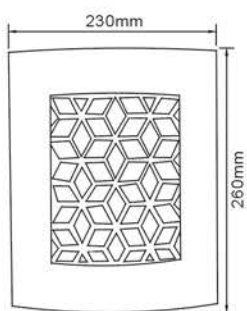

● EL-791

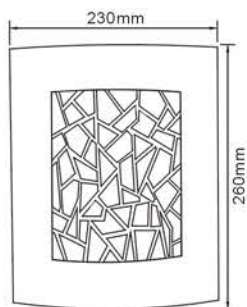

● EL-792

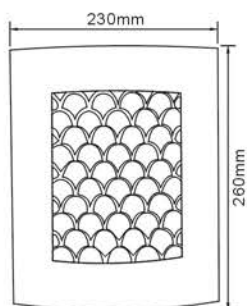

● EL-793



Exterior Spot Light

- Material: Aluminum Die Cast
- Finish: Polished Alum/Black
- IP44

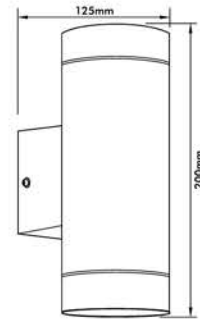

● **EL-413-2**

Bulb Adaptable: 2 x GU10 5W LED Bulb 

● **ELED-413-2**

Lamp: 6W (2 x 3W LED)

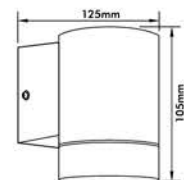

● **EL-413**

Bulb Adaptable: GU10 5W LED Bulb 

● **ELED-413**

Lamp: 3W (1 x 3W LED)

Exterior Lantern

- Material: Aluminum Body + Glass Diffuser
- Bulb Adaptable: GU10 Max. 5W LED Bulb
- Input Voltage: 220V ~ 240V
- Finish: Black
- IP44

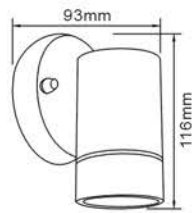

● EL-S416W

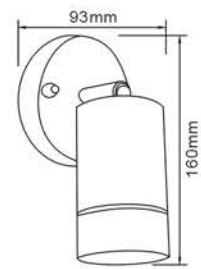

● EL-416W

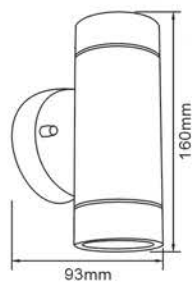

● EL-416W-2

2 x GU10 Max. 5W LED Bulb



Exterior Spot Light

- Material: Stainless Steel + Glass
- Finish: Stainless Steel
- IP44

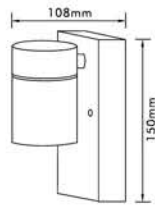

● **EL-426DN**
GU10 5W LED Bulb 

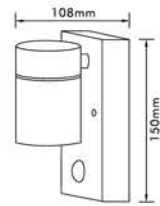

● **EL-426DNS**
GU10 5W LED Bulb 
With Sensor
Sensor Range: 8M x120°

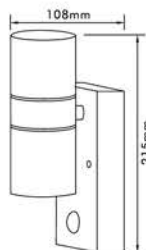

● **EL-426DN-2**
2 x GU10 5W LED Bulb 

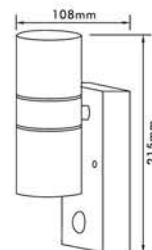

● **EL-426DNS-2**
2 x GU10 5W LED Bulb 
With Sensor
Sensor Range: 8M x120°

LED Garden Wall Light/Path Light

- Material: Stainless Steel Body + PC Diffuser
- Input Voltage: 220V ~ 240V
- Lamp: 10.8W (60pcs x 0.18W SMD2835 LED)
- Color Temperature: 2700K ~ 6400K
- Lumen: 640LM (4000K)
- IP44

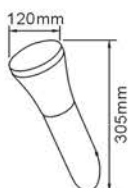

● **ELED-286W**

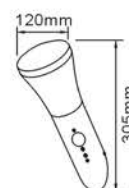

● **ELED-286WS**
With Sensor (8M, 120°)

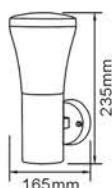

● **ELED-286**

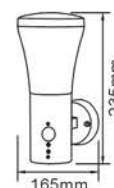

● **ELED-286S**
With Sensor (8M, 120°)

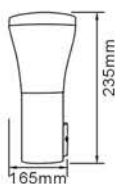

● **ELED-286A**

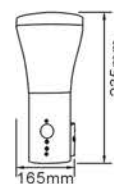

● **ELED-286AS**
With Sensor (8M, 120°)

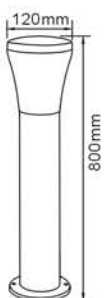

● **GPLED-286(0.8M)**

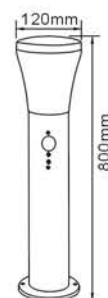

● **GPLED-286S(0.8M)**
With Sensor (8M, 120°)

Exterior Spot Light

- Material: Aluminium Die-cast
- Finish: Polished
- IP44

● EL-420W-1

Bulb Adaptable: GU10 5W LED bulb 



● EL-420W-2

Bulb Adaptable: 2 x GU10 5W LED Bulb 

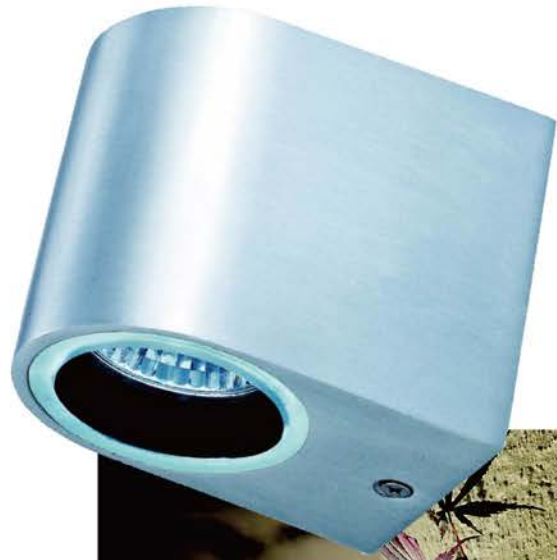

Exterior Spot Light

Home Resource 2017 Collection

Battery Operated LED Garden Sensor Light

- Material: ABS Body + PC Diffuser
- Battery: 3 x type C (Excl.)
- Battery Operation Time: 40H
- Color Temperature: 2700K ~ 6500K
- Luminous Flux: 65LM (6000K)
- PIR Sensor: 3~5M, 45 Secs, 100°
(Upon detection the motion: Light-on 45 Secs. Then light-off 10 secs. Cycles automatically if it detects the motion continually.)
- Color: White / Black
- IP44



● **GLED-187**

Lamp: 1.5W (4pcs x SMD5630 LED)

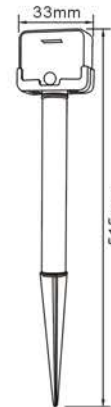

● **GLED-185**

Lamp: 1.2W (3pcs x SMD5630 LED)



Battery Operated LED Garden Sensor Light

- Material: ABS Body + PMMA Diffuser
- Lamp: 0.36W (6pcs x 0.06W Φ 5 LED)
- Battery: 6 x AAA (Excl.)
- Battery Operation Time: 24H
- Color Temperature: 2700K ~ 6500K
- Luminous Flux: 20LM (6000K)
- PIR Sensor: 3~5M, 45 Secs, 100°
(Upon detection the motion: Light-on 45 Secs. Then light-off 10 secs.
Cycles automatically if it detects the motion continually.)
- Color: White/Black/Silver
- IP44

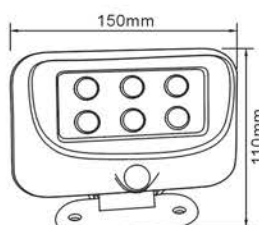

● **GLED-188S**
Standing or Wall Mounted

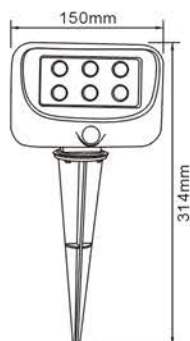

● **GLED-188SSP**



LED Garden Light

- Set of 3
- Material: Zinc Alloy + Aluminum + Glass
- Per head with 1 x 3W high power LED
- Lumen: 3 x 125LM (4000K)
- Each fitting with 1M SPT-2W (18awg) / H05RN-F 2 x 0.75mm² cable + 01 Plug
- Each set with 4M SPT-2W (18awg) / H05RN-F 2 x 0.75mm² extension cable + water-proof Female Plug + 01 Plug
- With Outdoor Driver
- Finish: Black
- IP44

Patented

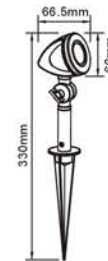

● GLED-862SP-S3



LED Garden Light

- Set of 3
- Material: Zinc Alloy + Aluminum + Glass
- Per head with 1 x 3W high power LED
- Lumen: 3 x 125LM (4000K)
- Each fitting with 1M SPT-2W (18awg) / H05RN-F 2 x 0.75mm² cable + 01 Plug
- Each set with 4M SPT-2W (18awg) / H05RN-F 2 x 0.75mm² extension cable + water-proof Female Plug + 01 Plug
- With Outdoor Driver
- Finish: Black
- IP44

Patented

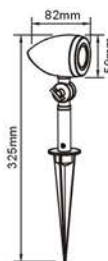

● GLED-863SP-S3



LED Garden Light

- Set of 3
- Material: Aluminum + Glass
- Per head with 1x3W high power LED
- Lumen: 3 x 270LM (4000K)
- Each fitting with 1M SPT-2W (18awg) / H05RN-F 2x0.75mm² cable + 01 plug
- Each set with 4M SPT-2W (18awg) / H05RN-F 2x0.75mm² cable + water-proof Female Plug + 01 plug
- With Outdoor Driver
- Finish: Aluminum / Black
- IP44



•Assembly

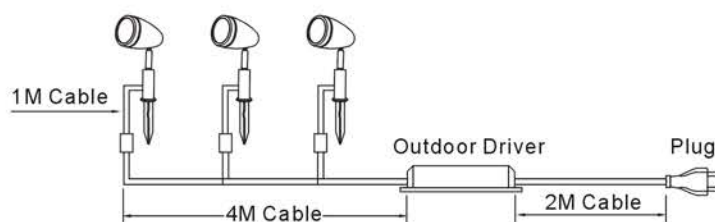

Exterior Spot Light

- Material: Die Cast Aluminium Body + Glass
- Bulb Adaptable: GU10 5W LED Bulb 
- Finish: Matt Black / Alu.
- IP44

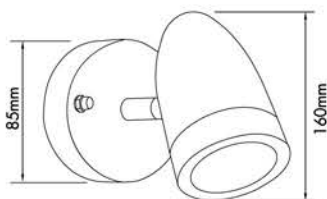

● WG-851



Garden Spot Light

- Material: Die Cast Aluminum Body + Glass Diffuser + Plastic Spike
- Bulb Adaptable: GU10 5W LED Bulb 
- With 1M H05RN-F 3x1.0mm² cable + connection box
- IP44

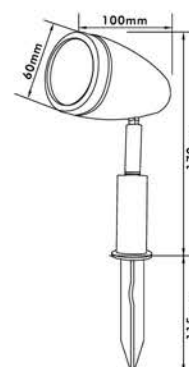

● GL-7438

Exterior Spot Light

- Material: Brushed Aluminum Alloy + Glass Shade
- IP44

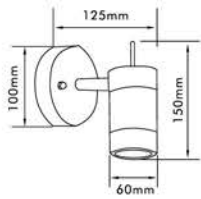

- **EL-860DN**
Bulb Adaptable: GU10 5W LED Bulb



- **GL-860SP**
Bulb Adaptable: MR16 5W LED Bulb

• Assembly

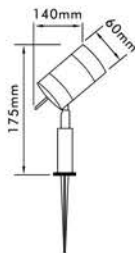
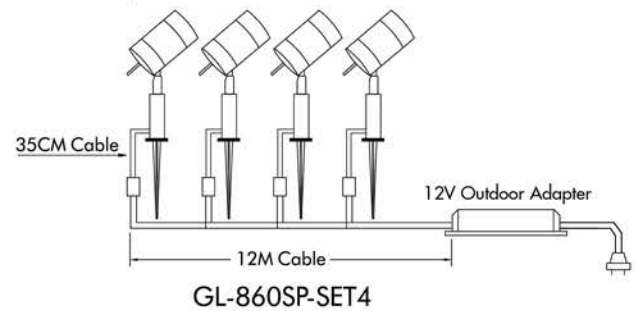

Garden Spot Light

- Material: Die Cast Aluminum + Glass Lens
- Bulb Adaptable: MR16 5W LED Bulb
- Finish: Aluminum
- IP44

• Assembly

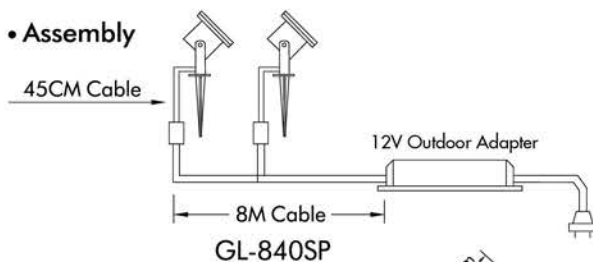

- **GL-840SP**

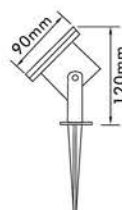

LED Garden Light

- Set of 3
- Material: Aluminum Die-Cast + Glass
- Lamp: Per head with 1 x 3W COB LED
- Color Temperature: 2700~6500K
- Lumen: 3 x 100LM (4000K)
- Each Fitting with 1M SPT-2W (18awg) / 1M H05RN-F 2 x 0.75mm² cable + DC Plug
- Each set with 4M SPT-2W (18awg) / 4M H05RN-F 2 x 0.75mm² extension cable + waterproof Female Plug + DC Plug
- With Outdoor Driver
- Finish: Black
- IP44



● GLED-850SP-S3

● Assembly

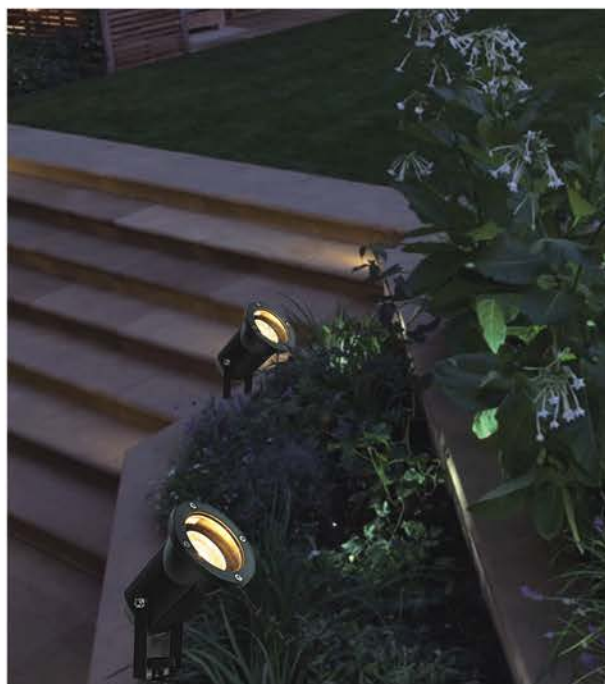
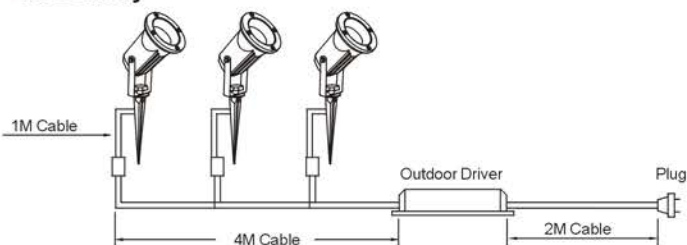

Garden Spot Light

- Material: Die Cast Aluminium + Glass
- Bulb Adaptable: MR16 5W LED Bulb 
- Finish: Black/White
- IP44

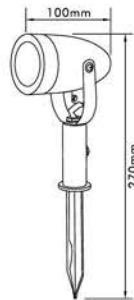

● GL-653SP

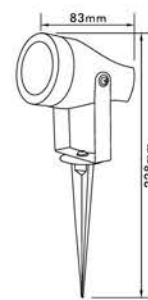

● GL-949SP



- Material: Die Cast Aluminum + Glass
- Bulb Adaptable: GU10 5W LED Bulb 
- Finish: Black/White
- IP54

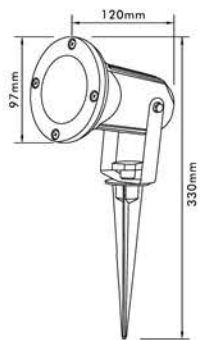

● GL-850SP



Garden Spot Light

- Material: Die Cast Aluminum
- Bulb Adaptable: MR16 5W LED Bulb 
- IP68

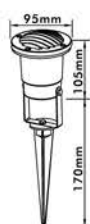

● GL-820SP

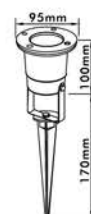

● GL-810SP

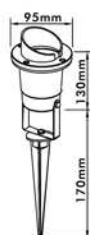

● GL-830SP



◆ Assembly

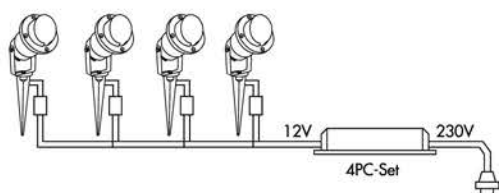

◆ Accessories



H05RN2 x 1.0mm

Outdoor Driver
Input 230V or 110V, Output 12V

Exterior Lantern

Home Resource 2017 Collection

Exterior Lantern

- Material: Aluminum Die-Cast Body + Glass Shade
- Bulb Adaptable: G45 6W LED Bulb
- Finish: Black / White

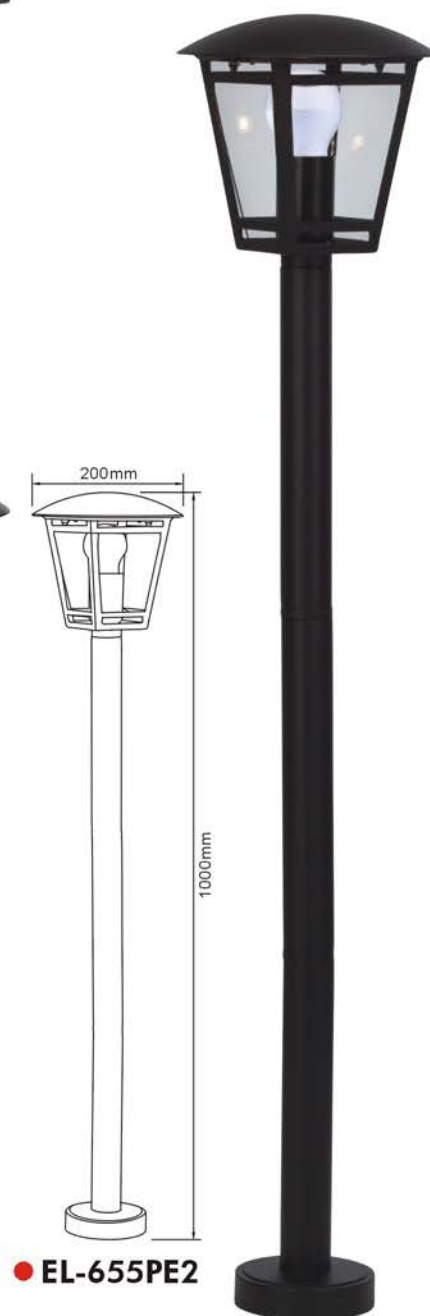
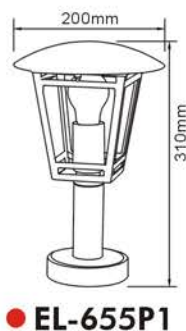

Exterior Lantern

- Material: Aluminum + PC Diffuser
- Bulb Adaptable: E27 6W LED Bulb 
- Input Voltage: 220V-240V
- Finish: Black
- IP44

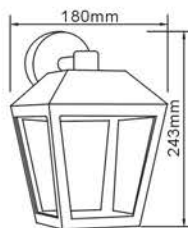

● **EL-734**

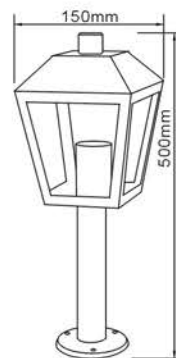

● **GPL-734**
(0.5M)

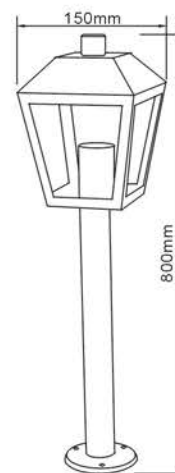

● **GPL-734**
(0.8M)

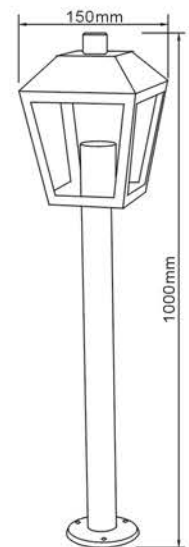

● **GPL-734**
(1M)

Exterior Lantern

- Material: Die Cast Aluminum + Frosted Glass
- Bulb Adaptable: E27 10W LED Bulb 
- Finish: Black

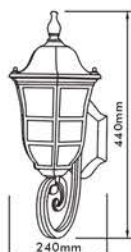

● **EL-252UP**
IP44

● **EL-252UP**

Product size: 24 x 20 x 44cm

● **EL-252DN**

Product size: 24 x 20 x 44cm

● **EL-252HG**

Product size: 20 x 18 x 32cm

● **EL-252P2**

Product size: 20 x 18 x 41cm

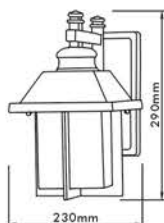

● **EL-253DN**
IP23

● **EL-253UP**

Product size: 23 x 16 x 29cm

● **EL-253DN**

Product size: 23 x 16 x 29cm

● **EL-253HG**

Product size: 16 x 16 x 26cm

● **EL-253P1**

Product size: 16 x 16 x 33cm

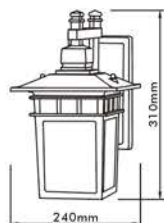

● **EL-254DN**
IP23

● **EL-254UP**

Product size: 24 x 18 x 37cm

● **EL-254DN**

Product size: 24 x 18 x 31cm

● **EL-254HG**

Product size: 18 x 18 x 27cm

● **EL-254P2**

Product size: 18 x 18 x 38cm

Exterior Lantern

- Material: Die Cast Aluminum + Frosted Glass
- Bulb Adaptable: E27 10WLED Bulb
- Finish: Black

● EL-257UP	Product size: 22 x 16 x 28cm
● EL-257DN	Product size: 22 x 16 x 25cm
● EL-257HG	Product size: 16 x 16 x 22cm
● EL-257P2	Product size: 16 x 16 x 31cm

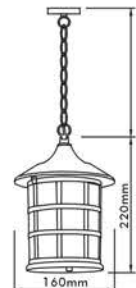

● EL-257HG
IP23



● EL-255DN
IP44

● EL-255UP	Product size: 24 x 19 x 37cm
● EL-255DN	Product size: 25 x 19 x 44cm
● EL-255HG	Product size: 19 x 19 x 32cm
● EL-255P2	Product size: 19 x 19 x 32cm



● EL-256P2
Die Cast Aluminum + Clear Glass
IP44

● EL-256UP	Product size: 20.5 x 16 x 26cm
● EL-256DN	Product size: 20.5 x 16 x 25cm
● EL-256HG	Product size: 16 x 16 x 22cm
● EL-256P2	Product size: 16 x 16 x 30cm

Exterior Lantern

- Material: Die Cast Aluminum + Glass
- Bulb Adaptable: E27 10W LED Bulb 
- Finish: Black
- IP44

● EL-258UP

Product size: 23 x 16 x 33cm

● EL-258DN

Product size: 23 x 16 x 36.5cm

● EL-258HG

Product size: 16 x 16 x 35.5cm



● EL-258DN



● EL-259UP

Product size: 27 x 23 x 38cm

● EL-259DN

Product size: 27 x 23 x 38cm

● EL-259HG

Product size: 23 x 23 x 33cm



● EL-259DN



● EL-268DN

● EL-268UP

Product size: 24 x 19 x 36cm

● EL-268DN

Product size: 24 x 19 x 36cm

● EL-268HG

Product size: 19 x 19 x 31cm



● EL-269DN

● EL-269UP

Product size: 25 x 23 x 34cm

● EL-269DN

Product size: 25 x 23 x 34cm

● EL-269HG

Product size: 23 x 23 x 30cm

Alum Exterior Lantern-Milano

- Material: Die Cast Aluminum + Acid Glass
- Bulb Adaptable: E27 10W LED Bulb
- Finish: Red Antique Brass/Verdi Green/
Matt Rust/Black Gold
- IP44

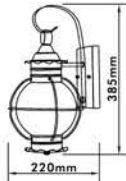

● EL-798DN



● EL-798HG

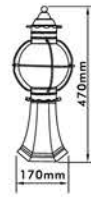

● EL-798P2

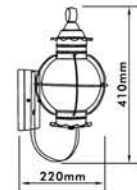

● EL-798UP

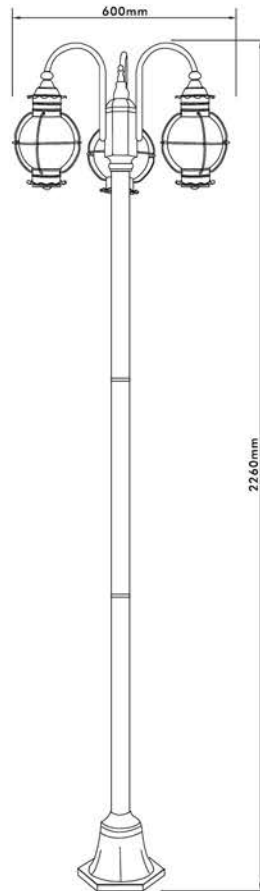

● EL-798PE3

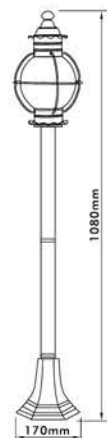

● EL-798PE2



Exterior Lantern

- Material: Aluminum + Glass
- Bulb Adaptable: E27 6W LED Bulb
- Finish: Granulated Black Brushed Red/
Granulated Black/Black Gold/Matt Rust
- IP44



● EL-733UP



● EL-733HG



● EL-733DN



● EL-733P1

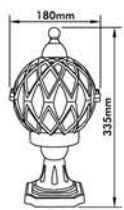

● EL-733P2

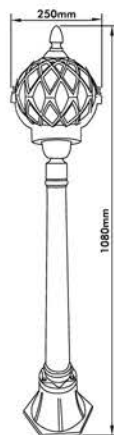

● EL-733PE2

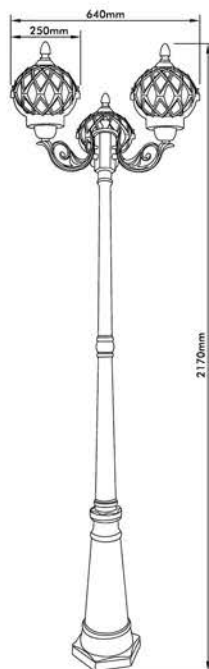

● EL-733PE3-3

Aluminum Outdoor Lantern-Noble

- Material: Die Cast Aluminum + Glass
- Bulb Adaptable: E27 10W LED Bulb
- Finish: Black / White / Black Gold / Verdi Green
- IP44



● EL-640UP



● EL-640DN



● EL-640HG



● EL-640P1



● EL-640P2

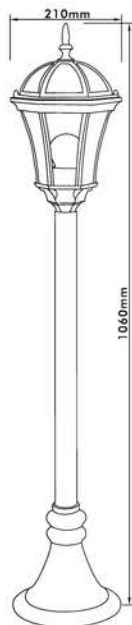

● EL-640PE2



Exterior Lantern

- Material: Die Cast Aluminum + Glass
- Bulb Adaptable: E27 10W LED Bulb A type
- Finish: White/Black/Matt Rust/Black Gold/Verdi Green
- IP44



● ● EL-560PE3



● ● EL-560P2



● ● EL-560HG



● ● EL-560DN



● ● EL-560UP



● ● EL-560UPS



● ● EL-560P1



Exterior Lantern

- Material: Die Cast Aluminum + Glass
- Bulb Adaptable: E27 10W LED Bulb A type 
- Finish: Black/White/Verdi Green/
Black Gold/Matt Rust
- IP44



● ● **EL-260PE2**
Overall Ht: 1M



● ● **EL-260HG**



● ● **EL-260DN**



● ● **EL-260UP**



● ● **EL-260UPS**
Sensor Range: 10M x 110°



● ● **EL-260P2**



● ● **EL-260P1**

Exterior Lantern in PC

- Material: PC (PP)
- Bulb Adaptable: E27 10W LED Bulb A type 
- Finish: White/Black
- IP44



● ● EL-P490DN



● ● EL-P490UP



● ● EL-P490P2

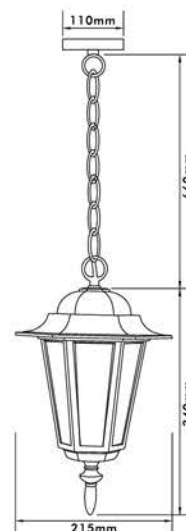

● ● EL-P490HG

Exterior Lantern in PC

- Material: PC (PP)
- Bulb Adaptable: E27 10W LED Bulb A type 
- Finish: White / Black
- IP44



● ● EL-P280HF

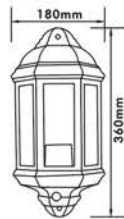

● ● EL-P280HFS

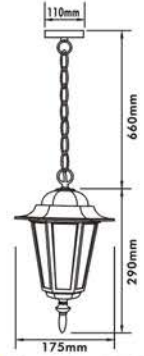

● ● EL-P270(A)HG



● ● EL-P270(A)UP



● ● EL-P270(A)P2



● ● EL-P270(A)DN

Exterior Lantern

- Material: PP Body + Glass Clear Shade
- Bulb Adaptable: E27 LED 6W 
- Finish: White / Black Body
- IP44

CE



Exterior Lantern

- Material: PP Body + Glass Clear Shade
- Bulb Adaptable: E27 LED 6W 
- Finish: White / Black Body
- IP44



● EL-P380UP



● EL-P380DN



● EL-P380P2

Exterior Lantern

- Material: PC Frame + PC Clear/Milky White Shade
- Bulb Adaptable: E27 LED 6W 
- Finish: Black/White

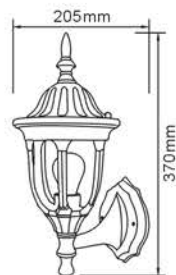

● EL-P180AUP



● EL-P180AHG



● EL-P180ADN



● EL-P180AP2



● EL-P180APE2



Exterior Lantern

- Material: PC Frame + PC Clear/Milky White Shade
- Bulb Adaptable: E27 LED 6W 
- Finish: Black/White



● EL-P260AUP



● EL-P260AHG



● EL-P260ADN



● EL-P260AP2

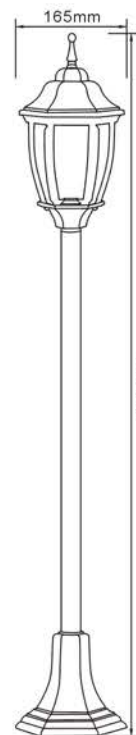

● EL-P260APE2



Exterior Lantern

- Material: PC Frame + PC Clear/Milky White Shade
- Bulb Adaptable: E27 LED 6W 
- Finish: Black/White



● EL-P799UP

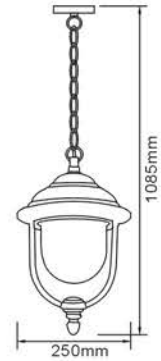

● EL-P799HG

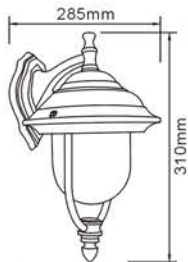

● EL-P799DN

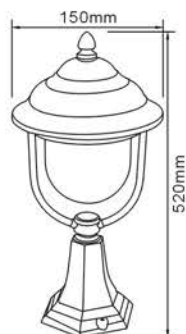

● EL-P799P2

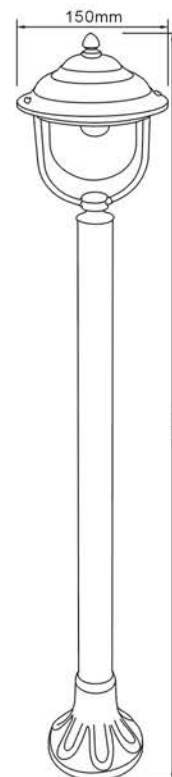
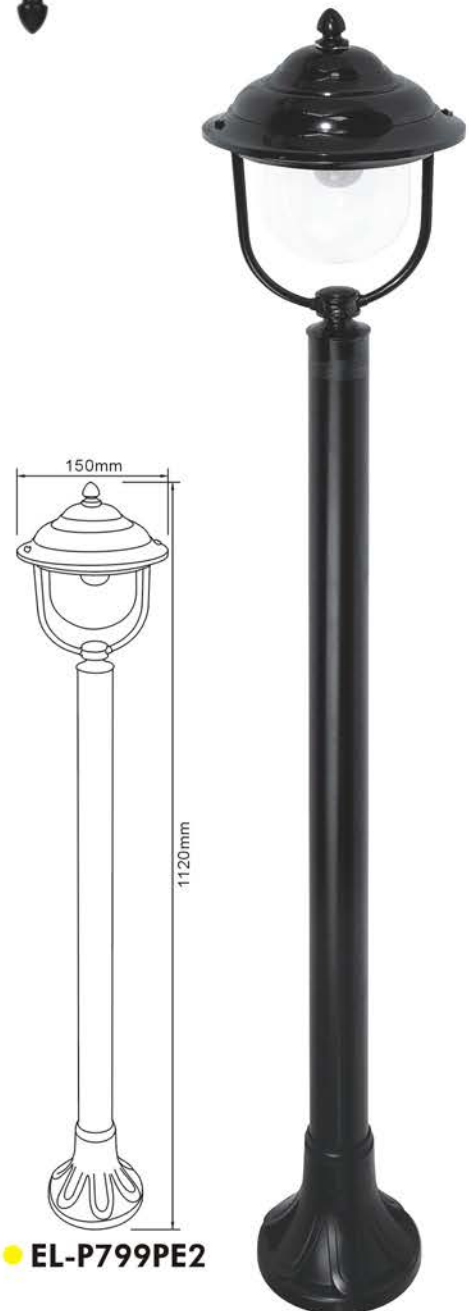

● EL-P799PE2

Exterior Lantern

- Material: Aluminum + Bubble Glass
- Bulb Adaptable: E27 10W LED Bulb
- Finish: Black
- IP23



● EL-448LUP



● EL-448SUP



● EL-448LDN



● EL-448SDN



● EL-448LHG

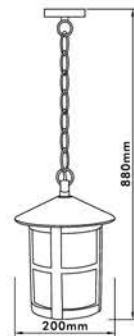

● EL-448SHG

Exterior Lantern

- Material: Aluminum + Glass
- Bulb Adaptable: E27 10W LED Bulb
- Finish: Black
- IP44



● EL-447HG

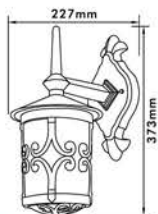

● EL-447DN

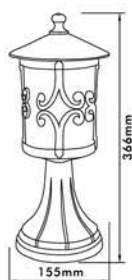

● EL-447P2



Exterior Solar Light

Home Resource 2017 Collection

Solar Light

- Material: Polyresin
- Amorphous solar panel
- Color: Colorful

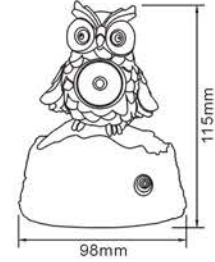

● **SOL-147**

Solar Panel: 43x25mm, 2V 20mAh
Lamp: 1pc White LED
Battery: 1pc AA NI-MH 300mAh

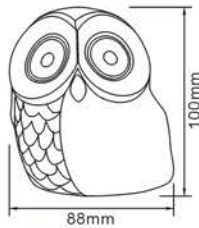

● **SOL-148**

Solar Panel: 43x25mm, 2V 20mAh
Lamp: 2pcs White LED
Battery: 1pc AA NI-MH 300mAh

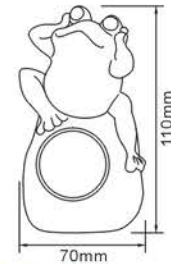

● **SOL-149**

Solar Panel: 30x30mm, 2V 10mAh
Lamp: 1pc White LED
Battery: 1pc AAA NI-MH 600mAh

Solar Light

- Material: Polyresin
- Battery: 1xAA/200MAH/NIMH
- Lamp: 4pcs White LED
- Finish: Grey

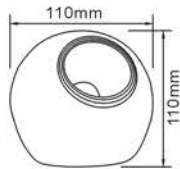

● SOL-215S

Solar panel: amorphous 40*40mm

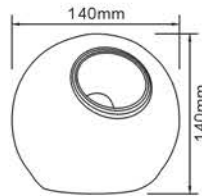

● SOL-215M

Solar panel: amorphous 40*40mm

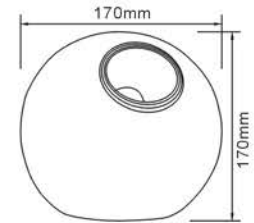

● SOL-215L

Solar panel: amorphous 30×30mm



Solar Light

- Material: Glass + Steel
- Finish: Chrome

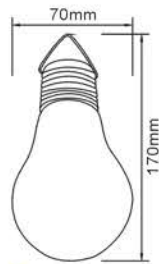

● SOL-410

Solar Panel: 2V 20mAh
Battery: 1 pc 1.2V AAA NI-MH 80mAh



Solar Panel: 2V 30mAh
Battery: 1 pc 1.2V AA NI-MH 300mAh



● SOL-413

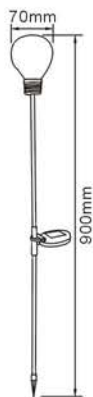

● SOL-412

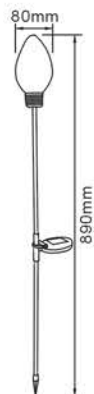

● SOL-411

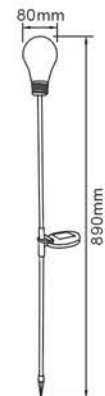

Solar Light

- Material: PVC + Steel
- Solar Panel: 2V 30mAh
- Battery: 1pc 1.2V AA NI-MH 300mAh
- Finish: Blue/Green/Orange/Transparent/Pink



● SOL-414



● SOL-415

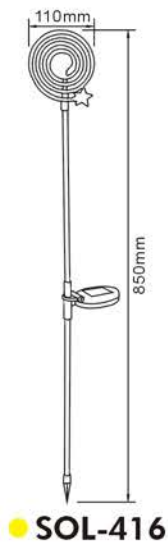

● SOL-416



Solar Light

- Material: Glass + Steel
- Finish: Blue/Green/Orange/Transparent

Solar Panel: 2V 30mAh

Battery: 1pc 1.2V AA NI-MH 300mAh

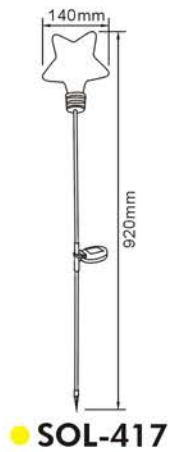

● SOL-417



● SOL-418



● SOL-419

Solar Panel: 2V 20mAh

Battery: 1pc 1.2V AAA NI-MH 80mAh

Product size: $\Phi 7 \times H.17\text{cm}$

Solar Light

- Material: Plastic+Metal
- Solar Panel: 2V 20mAh
- Battery: 1pc 1.2V AAA NI-MH 120mAh
- Finish: Black

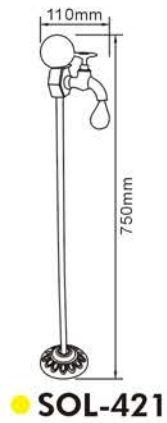

● SOL-421



● SOL-420

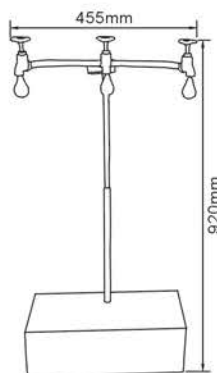

● SOL-422

Solar Light

- Material: Plastic + PVC
- Solar Panel: 2V 30mAh
- Battery: 1 pc 1.2V AAA NI-MH 300mAh
- Finish: Yellow/Pink/Blue/Transparent

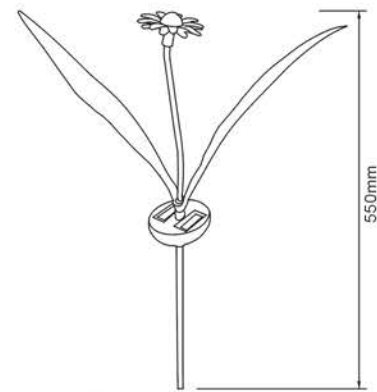

● SOL-423

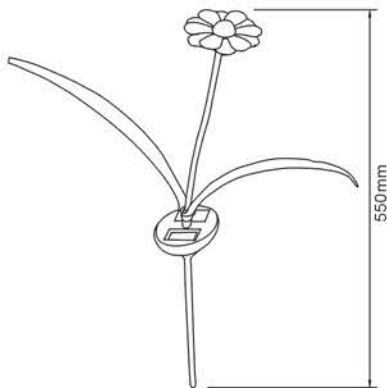
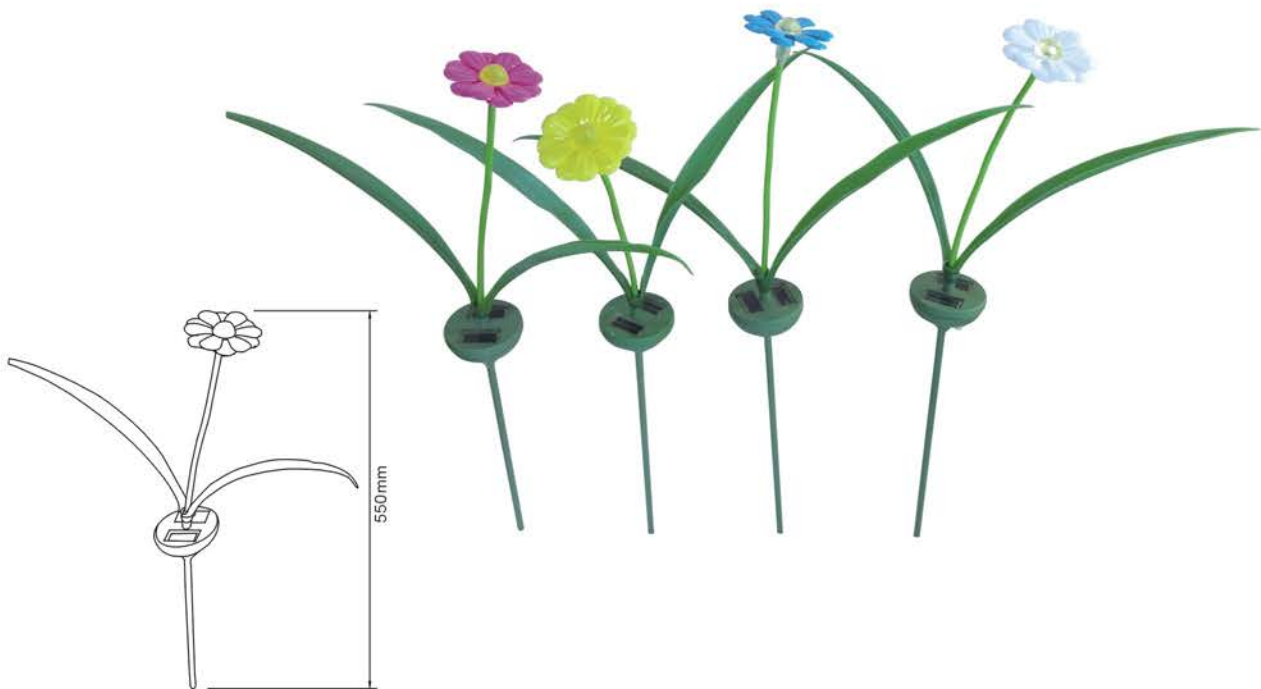

● SOL-423A

Solar Light

- Material: Steel + Glass + Plastic
- Solar Panel: Crystalline 25x43mm
- Battery: 1pc 1.2V AAA 200mAh
- Lamp: 1pc yellow LED
- With candle
- Finish: Red / Blue / Green

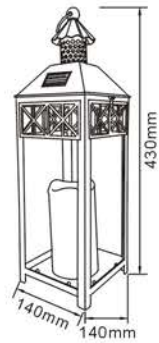

● SOL-446

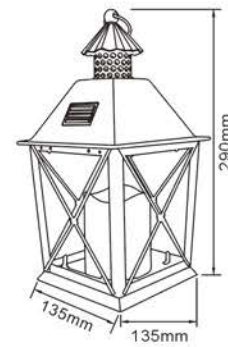

● SOL-447

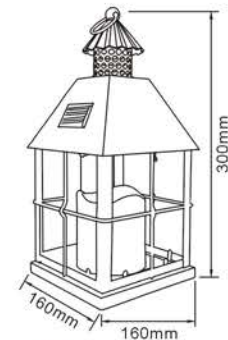

● SOL-448

Solar Light

- Material: Stainless steel+plastic
- Battery: 1 pc 1.2V AA NI-MH 200mA rechargeable battery
- Finish: Stainless steel



● SOL-457



● SOL-455

Solar Panel: 2V polycrystalline/80mA

Thermometer with Solar Light

- Material: Stainless Steel + ABS
- LED: 1 x 0.06W Super bright white LED
- Operating Time: 8 Hours fully charged
- Operating Temperature: $-20^{\circ}\text{C} \sim 70^{\circ}\text{C}$
- Mono/poly crystalline solar panels
- Finish: Stainless Steel

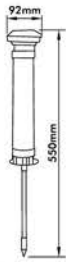

● SOL-301A

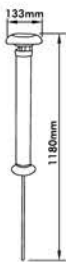

● SOL-301



● SOL-302

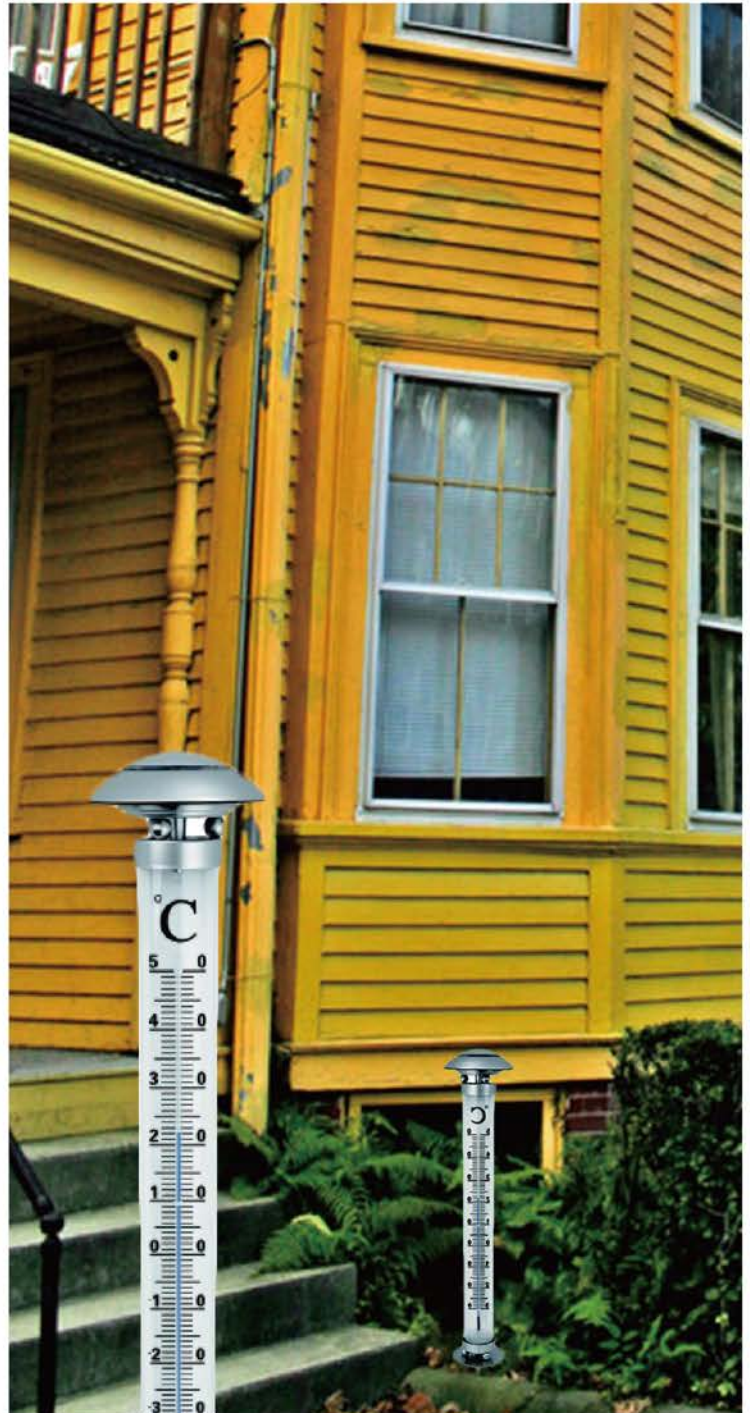

Exterior Socket Outlet

Home Resource 2017 Collection

Garden Outlet-**Socket**



- Material: Resin
- Voltage: 230V
- Rated Current: 16A
- With 1.5M H07RN-F3G1.5mm² Cable + VDE Plug
- Finish: Stone
- IP44



French Socket



German Socket

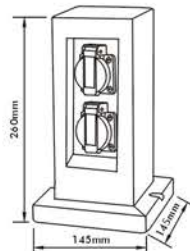

● **YG-311-2**
With 2 Sockets

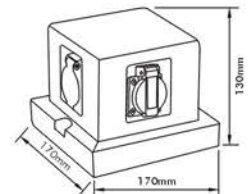

● **YG-247-2**
With 4 Sockets



Front

Rear

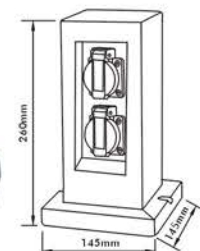

● **YG-311TM-2**
With 2 Sockets + 1 Mechanical Timer

Garden Outlet-**Socket**

- Material: Resin
- Voltage: 230V
- Rated Current: 16A
- With 1.5M H07RN-F3G1.5mm² Cable + VDE Plug
- Finish: Stone / Wood / White
- IP44



French Socket



German Socket



Stone



Wood

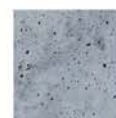

White



● **YG-S243-4**
With 4 Sockets

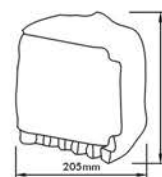

● **YG-S243TM-2**
With 2 Sockets + 1 Mechanical Timer

Stainless Steel Garden Socket

- Material: Stainless Steel
- Voltage: 220~240V 50Hz
- Rated Current: 16A
- Switching capacity: Max 3500 Watt Totally
- Finish: Stainless Steel Natural Color
- IP44

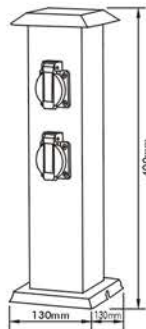

● **YG-312**
(2 sockets x 2 sides)

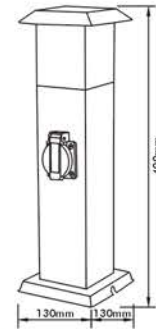

● **YG-313**
With PC shade
E27/4W LED Bulb
(Bulb Excl.)
One socket x 2 sides

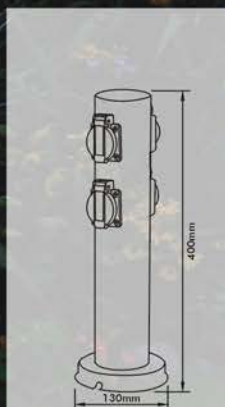

● **YG-314**
(2 sockets x 2 sides)

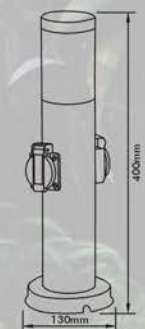

● **YG-315**
With PC shade
E27/4W LED Bulb
(Bulb Excl.)
One socket x 2 sides

Garden Path Light-Bollard & Garden Socket

- Material: Stainless Steel
- Bulb Adaptable: E27 10W LED Bulb A type 
- Finish: Stainless Steel
- VDE Socket
- IP44

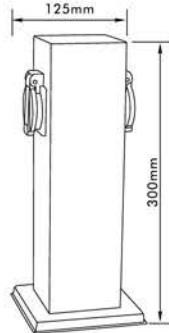

● GPL-58YG

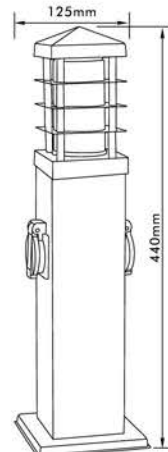
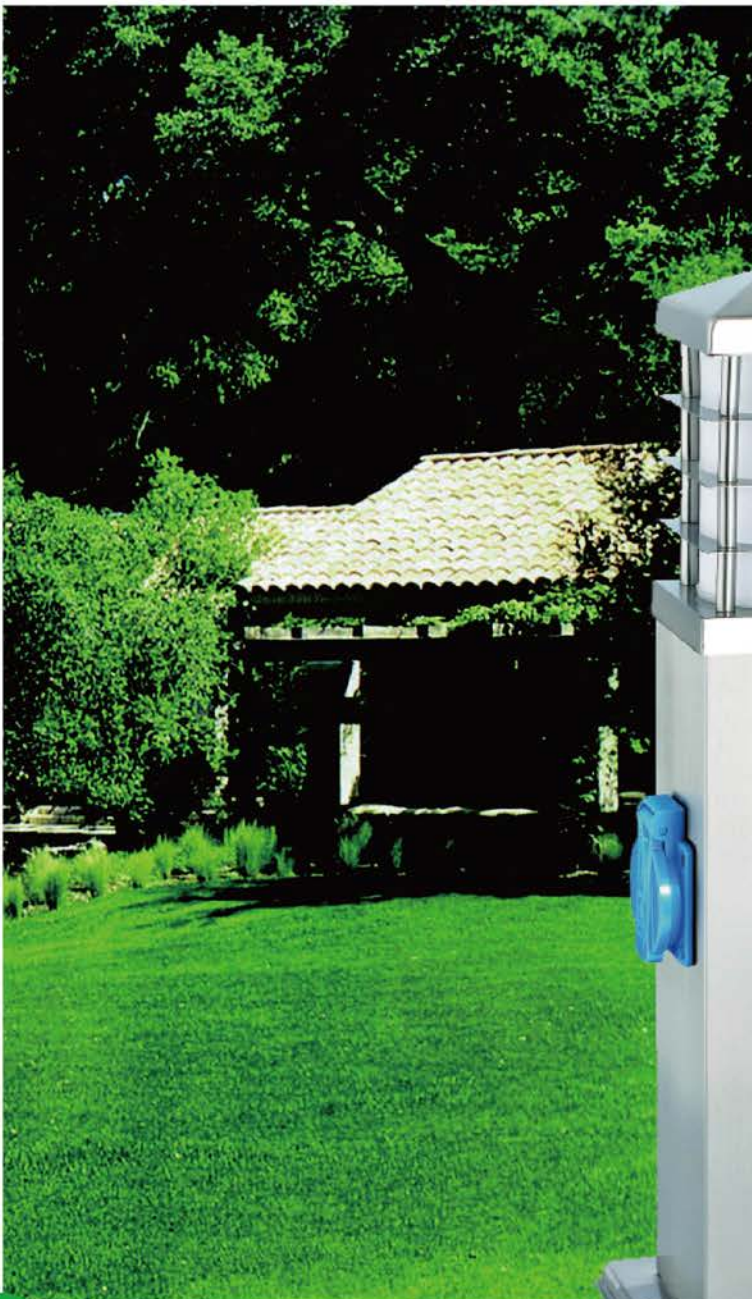

● GPL-58YG-A

Exterior Work Light / Flood Light

Home Resource 2017 Collection

AC Type Mini LED Flood Light

- Material: Aluminum + PC + Glass
- Voltage: 220V ~ 240V
- Color Temperature: 2800K ~ 6300K
- Finish: White
- IP65

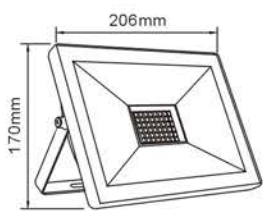

● **FLED-594B**

●	Lamp	Lumen	Product size
FLED-594B-10	10W (15pcs x SMD2835 LED)	700LM(4000K)	L. 10.5 x W. 3.2 x H. 9.6cm
FLED-594B-20	20W (30pcs x SMD2835 LED)	1400LM(4000K)	L. 12.6 x W. 3.3 x H. 11cm
FLED-594B-30	30W (42pcs x SMD2835 LED)	2100LM(4000K)	L. 18 x W. 3.8 x H. 15cm
FLED-594B-50	50W (54pcs x SMD2835 LED)	3500LM(4000K)	L. 20.6 x W. 4.3 x H. 17cm

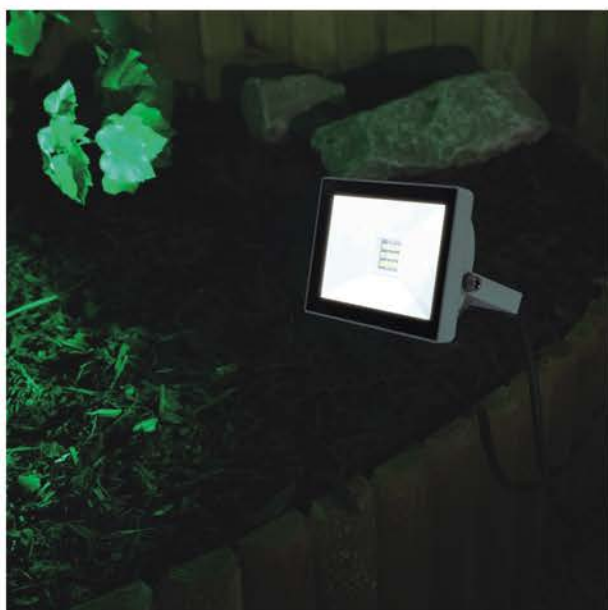

Ultra Slim Driver Built-in LED Flood Light

- Material: Aluminum Body + Glass Diffuser
- Voltage: AC 180V ~ 260V
- Color Temperature: 2800K ~ 6300K
- Finish: White Body + Black Printing

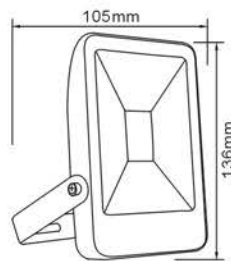

● **FLED-595-10**



●	Lamp	Lumen	IP	Product size
FLED-595-10	10W (15pcs x SMD2835 LED)	700LM(4000K)	65	L. 10.5 x W. 2 x H. 13.6cm
FLED-595-20	20W (30pcs x SMD2835 LED)	1400LM(4000K)	65	L. 14.2 x W. 2.5 x H. 18.2cm
FLED-595-30	30W (45pcs x SMD2835 LED)	2100LM(4000K)	65	L. 16.6 x W. 2.5 x H. 20.6cm
FLED-595-50	50W (75pcs x SMD2835 LED)	3500LM(4000K)	65	L. 20.6 x W. 3.3 x H. 25.6cm

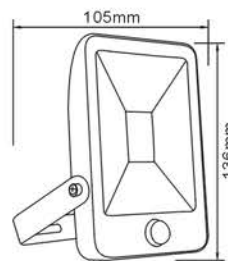

● **FLED-595S-10**
Sensor: 6M, 120°, 45 Secs

●	Lamp	Lumen	IP	Product size
FLED-595S-10	10W (15pcs x SMD2835 LED)	700LM(4000K)	44	L. 10.5 x W. 2 x H. 13.6cm
FLED-595S-20	20W (30pcs x SMD2835 LED)	1400LM(4000K)	44	L. 14.2 x W. 2.5 x H. 18.2cm
FLED-595S-30	30W (45pcs x SMD2835 LED)	2100LM(4000K)	44	L. 16.6 x W. 2.5 x H. 20.6cm
FLED-595S-50	50W (75pcs x SMD2835 LED)	3500LM(4000K)	44	L. 20.6 x W. 3.3 x H. 25.6cm

Super Slim LED Flood Light - AC Type (Driverless)

Patented

- Material: Aluminum Body and Reflector + PC Lens + Tempered Glass Diffuser
- Voltage: AC 180V ~ 260V
- Color Temperature: 4000K ~ 6500K
- CRI: Ra>80
- Finish: White Body + Black Printing



●	Lamp	Lumen	IP	Product size
FLED-594-10	10W (15pcs x SMD2835 LED)	700LM(4000K)	65	L. 12.6 x W. 3.3 x H. 11cm
FLED-594-20	20W (30pcs x SMD2835 LED)	1400LM(4000K)	65	L. 18 x W. 3.8 x H. 15cm
FLED-594-30	30W (45pcs x SMD2835 LED)	2100LM(4000K)	65	L. 20.6 x W. 4.3 x H. 17cm
FLED-594-50	50W (75pcs x SMD2835 LED)	3500LM(4000K)	65	L. 23.7 x W. 4.7 x H. 19cm



●	Lamp	Lumen	IP	Product size
FLED-594S-10	10W (15pcs x SMD2835 LED)	700LM(4000K)	44	L. 12.6 x W. 4.2 x H. 15.5cm
FLED-594S-20	20W (30pcs x SMD2835 LED)	1400LM(4000K)	44	L. 18 x W. 4.7 x H. 19.6cm
FLED-594S-30	30W (45pcs x SMD2835 LED)	2100LM(4000K)	44	L. 20.6 x W. 4.9 x H. 22cm

Sensor: 7M, 120°, 12 Seconds (Customization available, Max. Up to 30 minutes)

Super Slim LED Flood Light - AC Type (Driverless)

Patented

- Material: Aluminum Body and Reflector + PC Lens + Tempered Glass Diffuser
- Voltage: AC 180V ~ 260V
- Color Temperature: 4000K ~ 6500K
- CRI: Ra>80
- Finish: White



CE EMC RoHS



●	Lamp	Lumen	IP	Product size
FLED-593-10	10W (15pcs x SMD2835 LED)	700LM(4000K)	65	L. 15 x W. 2 x H. 12.1cm
FLED-593-20	20W (30pcs x SMD2835 LED)	1400LM(4000K)	65	L. 19 x W. 2.2 x H. 14.5cm
FLED-593-30	30W (39pcs x SMD2835 LED)	2100LM(4000K)	65	L. 22 x W. 2.2 x H. 17.5cm
FLED-593-50	50W (65pcs x SMD2835 LED)	3500LM(4000K)	65	L. 24.5 x W. 3.5 x H. 19.8cm



●	Lamp	Lumen	IP	Product size
FLED-593S-10	10W (15pcs x SMD2835 LED)	700LM(4000K)	44	L. 15 x W. 5.6 x H. 15.9cm
FLED-593S-20	20W (30pcs x SMD2835 LED)	1400LM(4000K)	44	L. 19 x W. 5.6 x H. 20cm
FLED-593S-30	30W (39pcs x SMD2835 LED)	2100LM(4000K)	44	L. 22 x W. 5.6 x H. 24.5cm
FLED-593S-50	50W (65pcs x SMD2835 LED)	3500LM(4000K)	44	L. 25 x W. 6.2 x H. 27cm

Sensor: 7M, 120°, 12 Seconds (Customization available, Max. Up to 30 minutes)

LED Flood Light-Deluxe Built-in EMC LED Driver

CE EMC



- Voltage: AC 180V ~ 260V
- Color Temperature: 2700K ~ 6500K
- CRI: Ra>70
- Finish: Black / White
- IP65

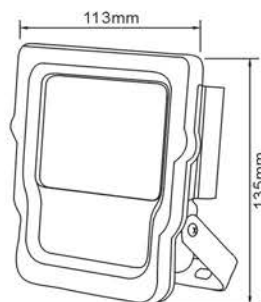

● FLED-581-10

●	Lamp	Lumen	Product size
FLED-581-10	10W(18pcs x 0.5W SMD5730 LED)	750LM(4000K)	L. 11.3 x W. 5 x H. 13.5cm
FLED-581-20	20W(36pcs x 0.5W SMD5730 LED)	1500LM(4000K)	L. 14.8 x W. 6.2 x H. 17.5cm
FLED-581-30	30W(54pcs x 0.5W SMD5730 LED)	2200LM(4000K)	L. 14.8 x W. 6.2 x H. 17.5cm
FLED-581-50	50W(92pcs x 0.5W SMD5730 LED)	3800LM(4000K)	L. 19 x W. 7.3 x H. 22.5cm

Material: Die-Cast Aluminum Body + Glass Diffuser

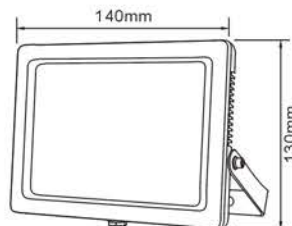

● FLED-585-10



●	Lamp	Lumen	Product size
FLED-585-10	10W(9pcs x 1W SMD2835 LED)	800LM(4000K)	L. 14 x W. 2.7 x H. 13cm
FLED-585-20	20W(18pcs x 1W SMD2835 LED)	1600LM(4000K)	L. 18 x W. 2.7 x H. 15cm
FLED-585-30	30W(27pcs x 1W SMD2835 LED)	2400LM(4000K)	L. 21 x W. 3 x H. 17cm
FLED-585-50	50W(48pcs x 1W SMD2835 LED)	4000LM(4000K)	L. 26 x W. 3 x H. 21cm

Material: Die-Cast Aluminum Body + PC Diffuser

Driver Built-In Super Slim LED Flood Light -Glare Free



CE EMC



CB

Patented

- Material: ABS Frame + PC Diffuser + Aluminum Housing
- Voltage: AC 180V ~ 265V
- Color Temperature: 4000K ~ 6500K
- CRI: Ra>70
- Finish: White Frame + Black Housing
- IP65

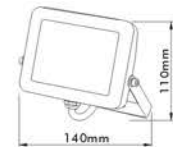

● FLED-592-10

10W (10pcs x 1W SMD2835 LED)
Lumen: 700LM(4000K)



● FLED-592-20

20W (20pcs x 1W SMD2835 LED)
Lumen: 1400LM(4000K)

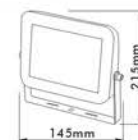

● FLED-592-30

30W(30pcs x 1W SMD2835 LED)
Lumen: 2100LM(4000K)



Driver Built-In Super Slim LED Flood Light -Glare Free



Patented

- Material: ABS Frame + PC Diffuser + Aluminum Housing (& Spike / Stand)
- Voltage: AC 180V ~ 265V
- Color Temperature: 4000K ~ 6500K
- CRI: Ra>70
- Finish: White Frame + Black Housing (+ Yellow Stand / Black Spike)
- IP65(IP44 for Sensor Type)



Sensor: 5M, 160°,
12 Seconds
(Customization
available, Max.
Up to 30 minutes)

● FLED-592S-10

- 10W (10pcs x 1W SMD2835 LED)
- Lumen: 700LM(4000K)
- Product size: 15 x 3.85 x 9.6 (13.2)cm

● FLED-592S-20

- 20W (20pcs x 1W SMD2835 LED)
- Lumen: 1400LM(4000K)
- Product size: 19.1 x 4.3 x 12.2 (16)cm

● FLED-592S-30

- 30W (30pcs x 1W SMD2835 LED)
- Lumen: 2100LM(4000K)
- Product size: 21.8 x 5.2 x 14 (17)cm



● FLED-592P1-10

- 10W (10pcs x 1W SMD2835 LED)
- Lumen: 700LM(4000K)
- Product size: 17.3 x 16.4 x 23cm

● FLED-592P1-20

- 20W (20pcs x 1W SMD2835 LED)
- Lumen: 1400LM(4000K)
- Product size: 22 x 18.4 x 27.5cm

● FLED-592P1-30

- 30W (30pcs x 1W SMD2835 LED)
- Lumen: 2100LM(4000K)
- Product size: 25.5 x 17.3 x 29.55cm

● FLED-592SP-10

- 10W (10pcs x 1W SMD2835 LED)
- Lumen: 700LM(4000K)
- Product size: 15 x 2.85 x 37.7cm

● FLED-592SP-20

- 20W (20pcs x 1W SMD2835 LED)
- Lumen: 1400LM(4000K)
- Product size: 19.1 x 3.3 x 40.5cm

● FLED-592SP-30

- 30W (30pcs x 1W SMD2835 LED)
- Lumen: 2100LM(4000K)
- Product size: 22 x 4.2 x 41.5cm



Driver Built-In Super Slim LED Flood Light -Glare Free



Patented

- Material: ABS Frame + PC Diffuser + Aluminum Housing & Stand
- Voltage: AC 180V ~ 265V
- Color Temperature: 4000K ~ 6500K
- CRI: Ra>70
- Finish: White Frame + Yellow Stand
- IP65

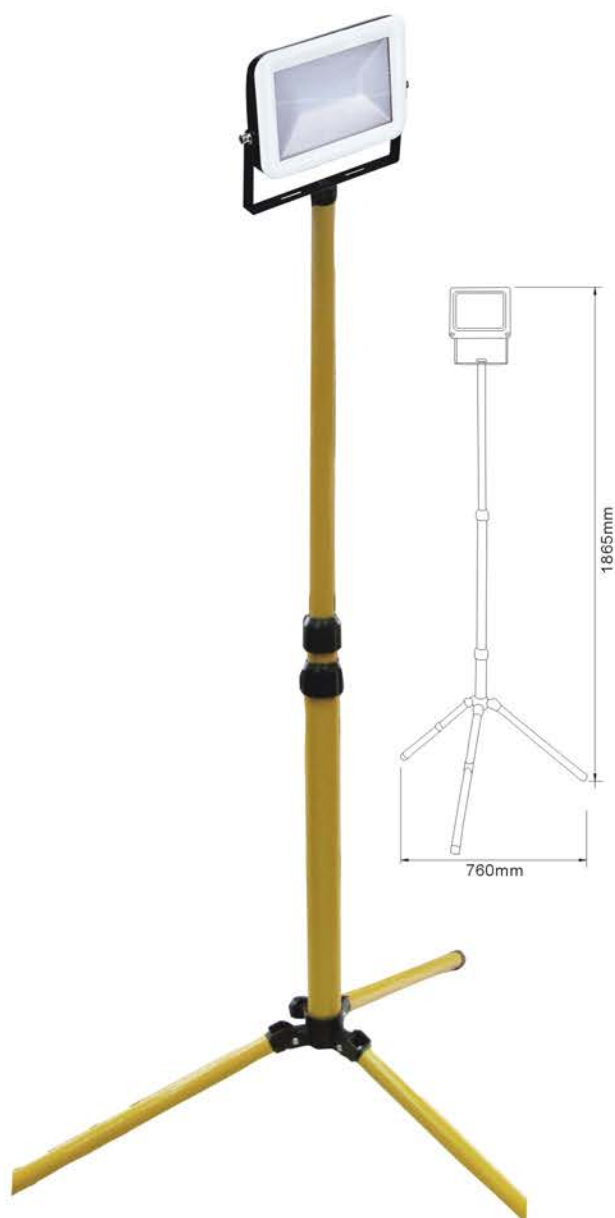

● FLED-592ST1-30

30W (30pcs x 1W SMD2835 LED)
Lumen: 2100LM(4000K)

● FLED-592ST2-30

60W (2 x 30pcs x 1W SMD2835 LED)
Lumen: 2 x 2100LM (4000K)

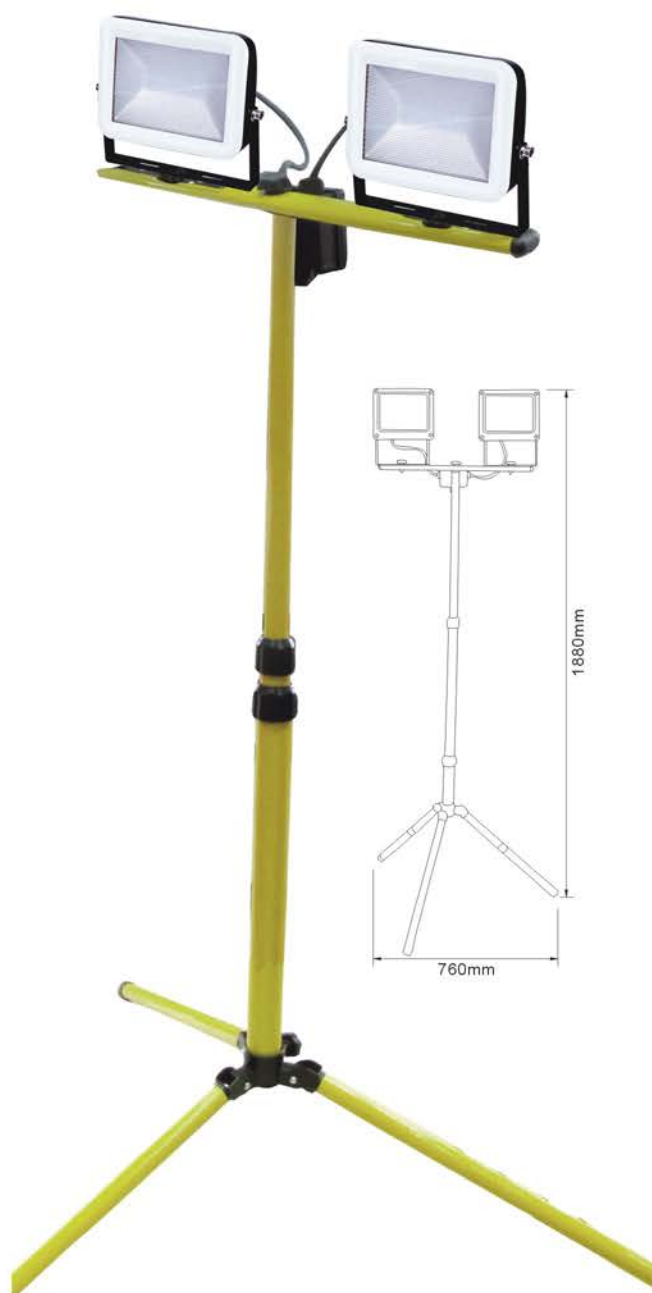

Driver Built-In Super Slim LED Flood Light -Glare Free



- Material: ABS body + PC Diffuser + Aluminum Heat Sink
- Voltage: AC 180V ~ 265V
- Color Temperature: 4000K ~ 6500K
- CRI: Ra>70
- Finish: White / Black / Grey Body
- IP65



● **FLED-591-16**

16W (16pcs x 1W SMD2835 LED)
Lumen: 1400LM (4000K)



● **FLED-591-08**

8W (8pcs x 1W SMD2835 LED)
Lumen: 700LM (4000K)



● **FLED-591-24**

24W (24pcs x 1W SMD2835 LED)
Lumen: 2100LM (4000K)



Rechargeable and Portable LED Flood Light -Slim

Rechargeable by 12V/24V Car charger, Mains Charger and *non-replaceable* Lithium Batteries

- Material: Die-Casting Aluminum Body + Tempered Glass Diffuser
- Color Temperature: 2700K ~ 6500K
- Battery: 2200mAh non-replaceable rechargeable Lithium Batteries included
- Accessories: Mains Charger (VDE plug), Car Charger and Lithium Batteries
- On/Off Switch
- Finish: Black Body + Yellow Stand
- IP65



100V~240V VDE
Mains Charger



12V/24V Car Charger

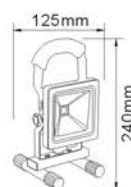

● FLED-557P1-10

●	Lamp	Lumen	Battery Available Time		18650 non-replaceable Rechargeable Lithium Batteries	Product size
			Fully Charge Time	Working Time		
FLED-557P1-10	10W COB	500LM (6000K)	3H	4.5H	2 x 8.4V 2200mAh batteries	L:12.5 x W:13.5 x H:24cm
FLED-557P1-20	20W COB	950LM (6000K)	5.5H	5H	4 x 8.4V 2200mAh batteries	L:21.5 x W:18.5 x H:29cm
FLED-557P1-30	30W COB	1400LM (6000K)	5H	4H	8 x 16.8V 2200mAh batteries	L:27.5 x W:22.5 x H:33.5cm

Rechargeable and Portable LED Flood Light **-Convenient and for Emergency use**

Rechargeable by 12V/24V Car charger, USB Cable, Mains Charger and *replaceable* Lithium Batteries

- Material: Die-Casting Aluminum Body + Tempered Glass Diffuser
- Color Temperature: 2700K ~ 6500K
- Lamp: 10W COB (270LM at 4000K)
- Battery: 3 x 3.7V 1800mAh replaceable rechargeable Lithium Batteries included
- Battery Working Time: 6H after fully charged about 5.5H
- Accessories: Mains Charger (VDE plug), Car Charger and Lithium Batteries
- 5-Way Switch: High-Medium-Low-Flash-Off
- Finish: Black Body + Yellow Stand
- IP44



100V~240V Mains Charger
(VDE Plug + USB Cable)



USB Cable



12V/24V Car Charger



3 x 3.7V 1800mAh 18650
Rechargeable Lithium
Batteries



3.7V 1800mAh 18650 replaceable
rechargeable Lithium Batteries



5-Way Switch:
High-Medium-Low-Flash-Off

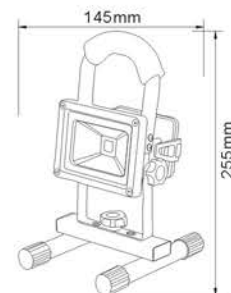

● FLED-B556P1-10

LED Flood Light

- Material: Aluminum Body + Tempered Glass
- Ra > 80
- Finish: Black housing (+Yellow Stand)
- IP44

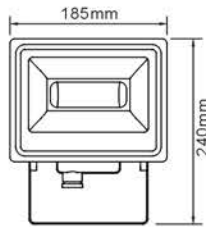

● **FLED-L530-20**

●	Lamp	Lumen	Product size
FLED-S530-10	10W(20pcs x 0.5W SMD5730 LED)	700LM(4000K)	L. 14 x W. 9 x H. 17.5cm
FLED-L530-20	20W(40pcs x 0.5W SMD5730 LED)	1400LM(4000K)	L. 18.5 x W. 10.4 x H. 24cm
FLED-L530-30	30W(60pcs x 0.5W SMD5730 LED)	2100LM(4000K)	L. 18.5 x W. 9.3 x H. 23.8cm
FLED-L530-50	50W(100pcs x 0.5W SMD5730 LED)	3600LM(4000K)	L. 24 x W. 11.5 x H. 28cm

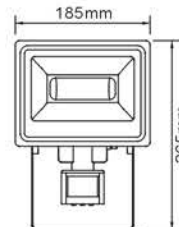

● **FLED-L530S-20**

●	Lamp	Lumen	Product size
FLED-S530S-10	10W(20pcs x 0.5W SMD5730 LED)	700LM(4000K)	L. 14 x W. 12 x H. 20.5cm
FLED-L530S-20	20W(40pcs x 0.5W SMD5730 LED)	1400LM(4000K)	L. 18.5 x W. 12 x H. 26.5cm
FLED-L530S-30	30W(60pcs x 0.5W SMD5730 LED)	2100LM(4000K)	L. 18.5 x W. 12 x H. 27cm
FLED-L530S-50	50W(100pcs x 0.5W SMD5730 LED)	3600LM(4000K)	L. 24 x W. 12 x H. 28cm

Sensor Range: 180° ; 12M Max.

LED Flood Light

- Material: Aluminum Body + Tempered Glass
- Ra > 80
- Finish: Black housing (+Yellow Stand)
- IP44

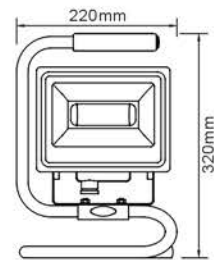

● **FLED-L530P-20**

●	Lamp	Lumen	Product size
FLED-S530P-10	10W(20pcs x 0.5W SMD5730 LED)	700LM(4000K)	L. 19 x W. 17 x H. 27.5cm
FLED-L530P-20	20W(40pcs x 0.5W SMD5730 LED)	1400LM(4000K)	L. 22 x W. 21 x H. 32cm
FLED-L530P-30	30W(60pcs x 0.5W SMD5730 LED)	2100LM(4000K)	L. 22 x W. 21 x H. 32cm
FLED-L530P-50	50W(100pcs x 0.5W SMD5730 LED)	3600LM(4000K)	L. 32.5 x W. 25 x H. 40.5cm

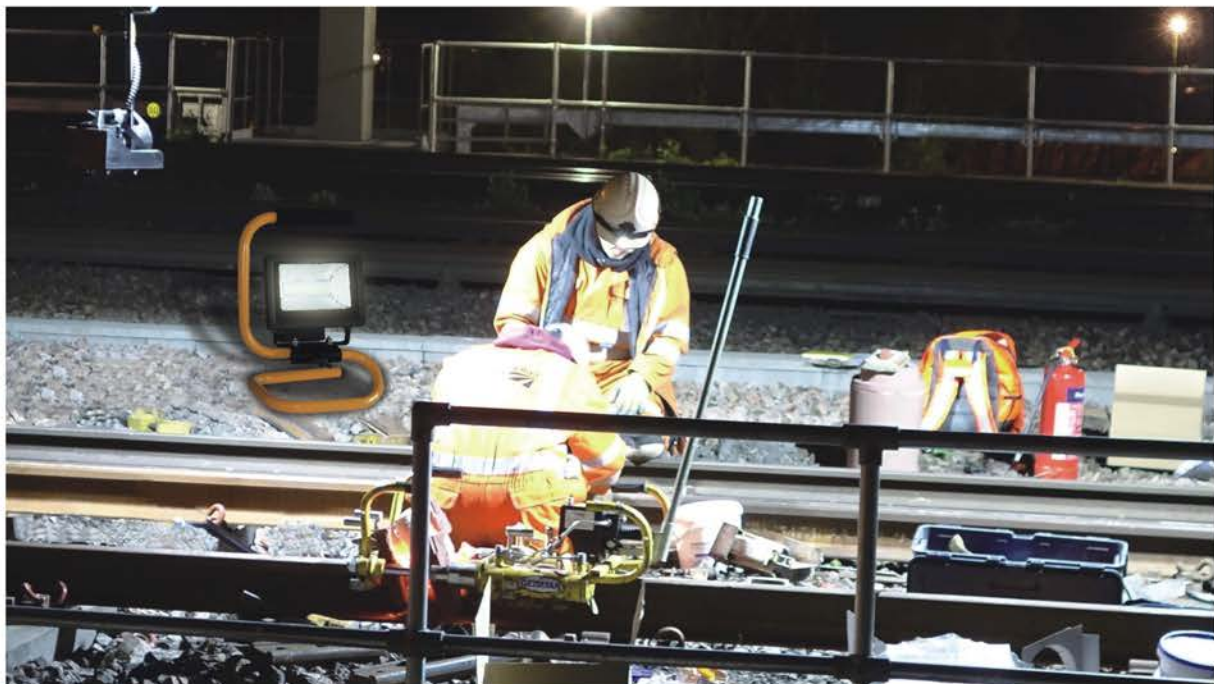

SMD LED Flood Light

- Material: Aluminum + PC + Glass
- Voltage: 180V ~ 260V
- Color Temperature: 2700K ~ 6300K
- 80LM/W
- Finish: Black
- IP65

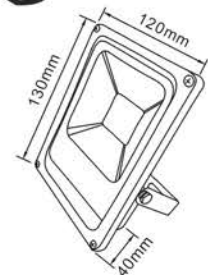

● ●	Lamp	Lumen	Product size
● ●	FLED-586-10 10W (20pcs x SMD2835 LED)	800LM(4000K)	L. 12 x W. 4 x H. 13cm
● ●	FLED-586-20 20W (42pcs x SMD2835 LED)	1600LM(4000K)	L. 18 x W. 4.5 x H. 14cm
● ●	FLED-586-30 30W (64pcs x SMD2835 LED)	2400LM(4000K)	L. 18.5 x W. 5 x H. 22.5cm
● ●	FLED-586-50 50W (104pcs x SMD2835 LED)	4000LM(4000K)	L. 23 x W. 6 x H. 28.5cm

● ● **FLED-586-10**



Floodlight Halogen

- Material: Die Cast Aluminum
- IP44



● **FL-7P**

J118 8W LED Bulb 



● **FL-7**

J118 8W LED Bulb 



● **FL-7S**

J118 8W LED Bulb 

● **FL-5P**

J78 5W LED Bulb 

● **FL-5**

J78 5W LED Bulb 

● **FL-5S**

J78 5W LED Bulb 



● **FL-7ST2**

2 x J118 8W LED Bulb 

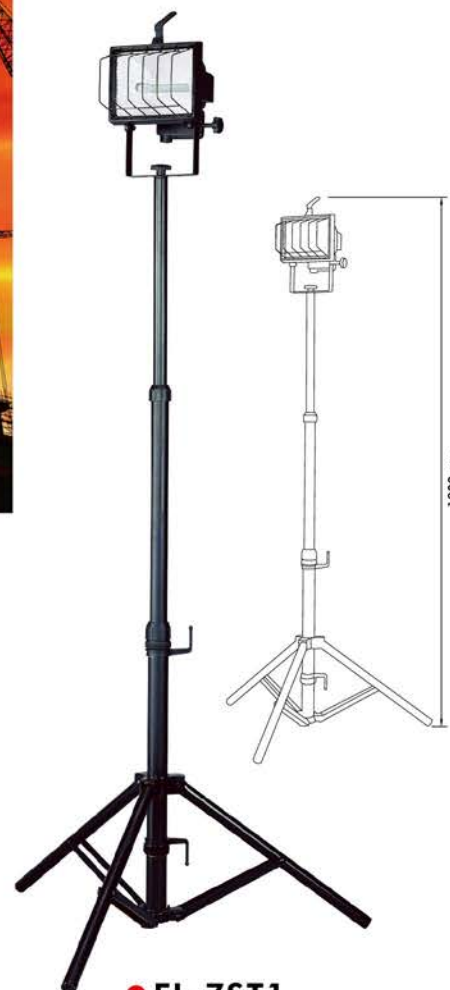

● **FL-7ST1**

J118 8W LED Bulb 

Fluorescent Work Light

- Material: Base(ABS) + Ball(PE)
- Bulb Adaptable: E27 20W LED Corn bulb
- Voltage: 230V
- 6M H07RN-F 3G 1.5MM² Cable + Plug
- IP44

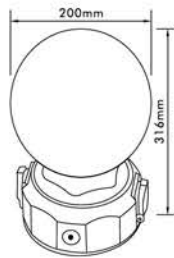

● OS-40PR

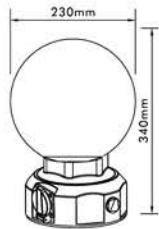

● OS-57PR



Exterior Ground Light & Deck Light

Home Resource 2017 Collection

LED In-ground Light

- Material: 304 Stainless Steel Cover
+ Die-Casting Aluminum Body + PP Housing
+ Clear Glass Diffuser
- Voltage: 220V ~ 240V
- Finish: Stainless Steel natural color for cover + Black color for housing
- IP67

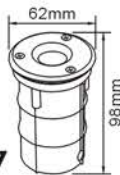

● **GLED-147**

Lamp: 3W (1 x 3W LED)
Luminous flux: 200LM (4000K)



● **GLED-SS139**

Lamp: 3W (3 x 1W LED)
Luminous flux: 200LM (4000K)



● **GLED-139A**

Lamp: 3W (3 x 1W LED)
Luminous flux: 200LM (4000K)

●	Lamp	Lumen	Product size
GLED-S139	9W (9 x 1W LED)	380LM (4000K)	Dia. 18 x H. 11.5cm
GLED-M139	12W (12 x 1W LED)	580LM (4000K)	Dia. 21 x H. 11.5cm
GLED-L139	18W (18 x 1W LED)	880LM (4000K)	Dia. 26 x H. 11.5cm
GLED-139-5	5W (5 x 1W LED)	250LM (4000K)	Dia. 16.2 x H. 10.5cm
GLED-139-6	6W (6 x 1W LED)	260LM (4000K)	Dia. 16.2 x H. 10.5cm
GLED-139-9	9W (9 x 1W LED)	380LM (4000K)	Dia. 16.2 x H. 10.5cm



● **GLED-139-5**



2-in-1 LED In-Ground Light & Deck Light

- Material: Aluminum
- Lamp: 2.4W (8 x 0.3W SMD2835 LED)
- With 1M 2x0.75mm² H05RN-F cable
- Finish: Silver
- IP68

CE EMC

With Red, Green, Blue Color Filters

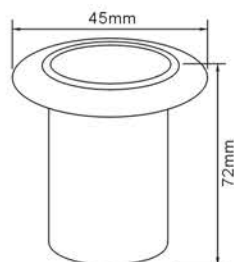

● GLED-148



LED Deck Light Set

- Set of 6
- Material: Stainless Steel + Tempered Glass
- With 5W VDE Driver
- RGB type is optional
- Finish: Stainless Steel
- IP67

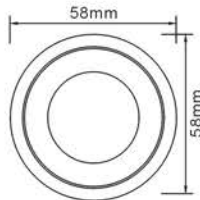

● DKLED-60-S6

Lamp: 6 x 0.5W SMD3350 LED (6000K)
Lumen: 7LM (6000K) per Light

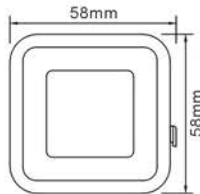

● DKLED-61-S6

Lamp: 6 x 0.6W SMD3350 LED (6000K)
Lumen: 9LM (6000K) per Light



Super Thin 9mm Thickness

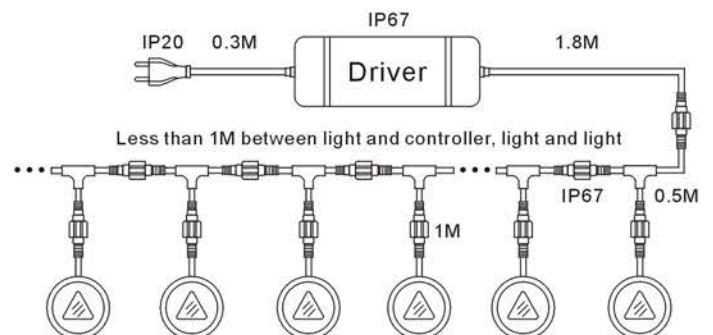

LED Deck Light Set

- Set of 6
- Material: Stainless Steel + PC
- With 5W VDE Driver
- Finish: Stainless Steel
- IP67



DKLED-63-S6

Lamp: 6 x 0.3W SMD3528 LED (6000K)
Lumen: 9 LM (6000K) per Light



DKLED-65-S6

Lamp: 6 x 0.6W SMD2835 LED (6000K)
Lumen: 40 LM (6000K) per Light
RGB type is optional



DKLED-64-S6

Lamp: 6 x 0.4W SMD3528 LED (3000K)
Lumen: 7 LM (3000K) per Light

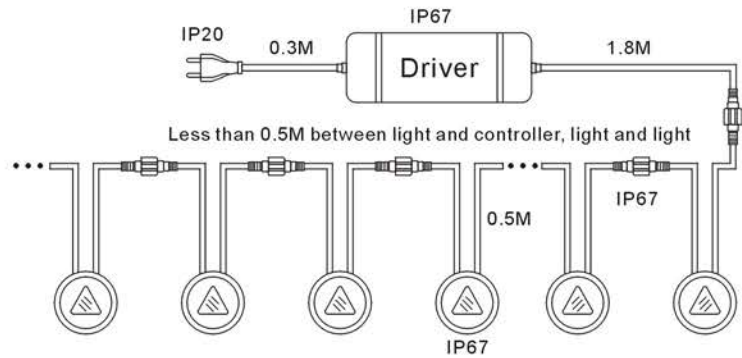

DKLED-62-S6

Lamp: 6 x 0.4W SMD5050 RGB LED
Lumen: 4LM (RGB) per Light
With IR RGB Controller(3M, 360°)

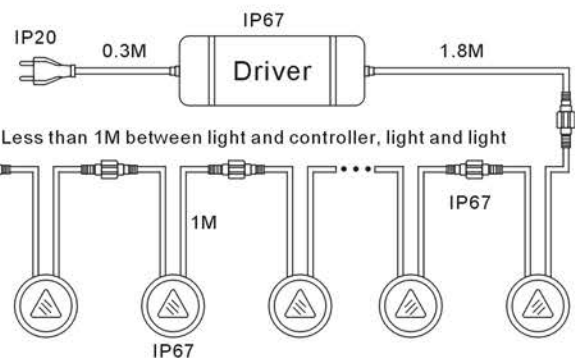
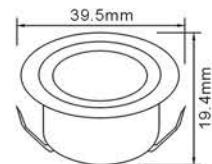

Exterior Bulkhead & Ceiling Light

Home Resource 2017 Collection

LED Exterior Ceiling Lamp

AC Type (Driverless)

Patented

- Material: ABS Body + PC Diffuser
- Voltage: AC 180V ~ 260V
- Color Temperature: 2700K ~ 6500K
- Finish: White / Black
- IP65



● **ALED-M573**

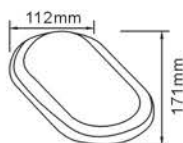

●	Watt	Lamp	Lumen	Product size
ALED-573	5W	21pcs x 0.2W SMD 2835 LED	350LM (4000K)	L.17.1 x W.11.2 x H. 7cm
ALED-M573	10W	20pcs x 0.5W SMD 2835 LED	650LM (4000K)	L.21.2 x W.13.4 x H. 7.7cm



● **ALED-M574**

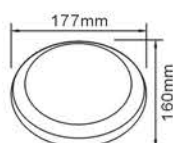

●	Watt	Lamp	Lumen	Product size
ALED-574	5W	21pcs x 0.2W SMD 2835 LED	350LM (4000K)	L.17.7 x W.16 x H. 7.3cm
ALED-M574	10W	20pcs x 0.5W SMD 2835 LED	650LM (4000K)	L.21.2 x W.19.7 x H. 8.2cm



● **ALED-M573S**

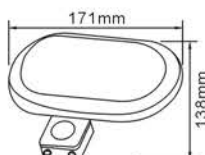

●	Watt	Lamp	Lumen	Product size
ALED-573S	5W	21pcs x 0.2W SMD 2835 LED	350LM (4000K)	L.17.1 x W.13.8 x H. 7cm
ALED-M573S	10W	20pcs x 0.5W SMD 2835 LED	650LM (4000K)	L.21.2 x W.15.8 x H. 7.7cm

Sensor: 120° , 8~10M, 5 Secs~12 Mins



● **ALED-M574S**

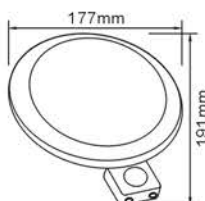

●	Watt	Lamp	Lumen	Product size
ALED-574S	5W	21pcs x 0.2W SMD 2835 LED	350LM (4000K)	L.17.7 x W.19.1 x H. 7.3cm
ALED-M574S	10W	20pcs x 0.5W SMD 2835 LED	650LM (4000K)	L.21.2 x W.22.7 x H. 8.2cm

Sensor: 120° , 8~10M, 5 Secs~12 Mins

LED Bulkhead

- Material: Aluminum Die-Casting Body + Opal PC Diffuser
- Voltage: 220V ~ 240V
- Finish: Black / White / Grey
- IP44

CE EMC

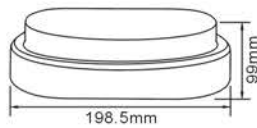

● **ALED-S583**

Lamp: 7W (40 x SMD2835 LED)
Lumen: 550LM (4000K)

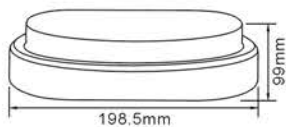

● **ALED-583**

Lamp: 10W (60 x SMD2835 LED)
Lumen: 850LM (4000K)

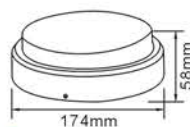

● **ALED-S584**

Lamp: 7W (40 x SMD2835 LED)
Lumen: 550LM (4000K)

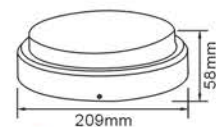

● **ALED-584**

Lamp: 10W (60 x SMD2835 LED)
Lumen: 850LM (4000K)

Driver Built-in Plastic LED Exterior Bulkhead

- Material: ABS Body + PC Diffuser
- Voltage: 85V ~ 265V
- Color Temperature: 2700K ~ 6500K
- CRI: Ra ≥ 70
- Finish: Black / White
- IP65



	Lamp	Lumen	Product size
ALED-558	6W (12pcs x 0.5W SMD5730 LED)	550LM	L: 18.7 x W: 12.7 x H: 7cm
ALED-M558	12W (24pcs x 0.5W SMD5730 LED)	1100LM	L: 23.9 x W: 16.2 x H: 9.7cm



	Lamp	Lumen	Product size
ALED-558A	6W (12pcs x 0.5W SMD5730 LED)	430LM	L: 18.7 x W: 12.7 x H: 7cm
ALED-M558A	12W (24pcs x 0.5W SMD5730 LED)	860LM	L: 23.9 x W: 16.2 x H: 9.7cm



	Lamp	Lumen	Product size
ALED-559	6W (12pcs x 0.5W SMD5730 LED)	550LM	Dia: 17.9 x H: 7.5cm
ALED-M559	12W (24pcs x 0.5W SMD5730 LED)	1100LM	Dia: 22 x H: 9.8cm



	Lamp	Lumen	Product size
ALED-559A	6W (12pcs x 0.5W SMD5730 LED)	430LM	Dia: 17.9 x H: 7.5cm
ALED-M559A	12W (24pcs x 0.5W SMD5730 LED)	860LM	Dia: 22 x H: 9.8cm

LED Bulkhead

- Material: Aluminum+PC
- Finish: White/Black
- Voltage : AC 85-265V
- SMD LED 5730
- Beam Angle 160(degree)
- Color Temperature 2700K-6400K (Optional)
- CRI>70
- with 30cm H05RNF3x1.0mm² cable
- Built-in Driver
- IP54
- Built-in Driver

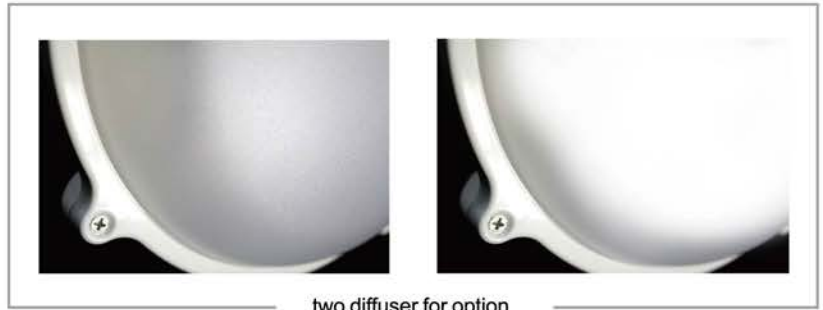

two diffuser for option

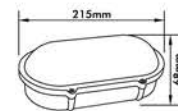
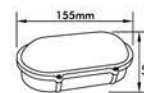

● **ALED-S562**

12 x 0.5W LED
Lumens: 400lms

● **ALED-M562**

24 x 0.5W LED
Lumens: 700lms

● **ALED-L562**

40 x 0.5W LED
Lumens: 1400lms

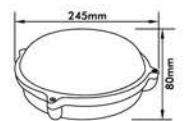
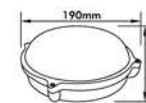
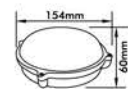

● **ALED-S563**

12 x 0.5W LED
Lumens: 400lms

● **ALED-M563**

24 x 0.5W LED
Lumens: 700lms

● **ALED-L563**

40 x 0.5W LED
Lumens: 1400lms

LED Bulkhead

- Material: Aluminum Die-Casting Body + PC Diffuser
- Voltage: 95V ~ 240V
- Lamp: 10W (20 x 0.5W SMD5630 LED)
- Lumen: 750LM (4000K)
- Color Temperature: 3200K ~ 6500K
- Finish: Black / Gray
- IP54



TÜVRheinland®
CE EMC

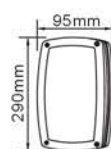

● ALED-A551

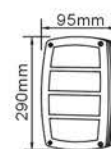

● ALED-A551A

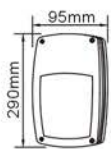

● ALED-A551B

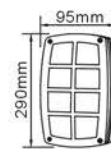

● ALED-A551C



LED Bulkhead

- Material: Aluminum Die-Casting Body + PC Diffuser
- Voltage: 95V ~ 240V
- Lamp: 20W (40 x 0.5W SMD5630 LED)
- Lumen: 1500LM (4000K)
- Color Temperature: 3200K ~ 6500K
- Finish: Black / Gray
- IP54

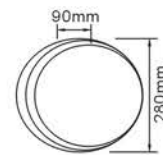

● ALED-120A

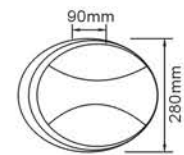

● ALED-120B

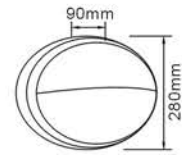

● ALED-120C

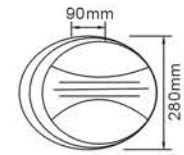

● ALED-120D



LED Bulkhead

- Material: Aluminum Die-Casting Body + PC Diffuser
- Voltage: 95V ~ 240V
- Lamp: 20W (40 x 0.5W SMD5630 LED)
- Lumen: 1500LM (4000K)
- Color Temperature: 3200K ~ 6500K
- Finish: Black / Gray
- IP54

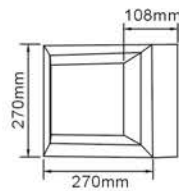

● ALED-121A

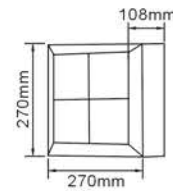

● ALED-121B

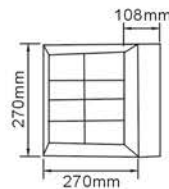

● ALED-121C

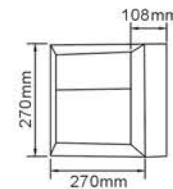

● ALED-121D



Bulkhead

- Material: Aluminum Die-Casting Body + PC Diffuser
- Voltage: 95V ~ 240V
- Lamp: 20W (40 x 0.5W SMD5630 LED)
- Lumen: 1500LM (4000K)
- Color Temperature: 3200K ~ 6500K
- Finish: Gray / Black
- IP54

 TÜVRheinland®
CE EMC

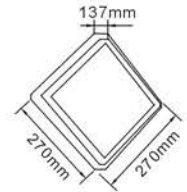

● **ALED-122A**

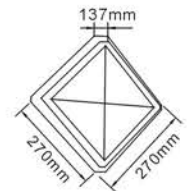

● **ALED-122B**

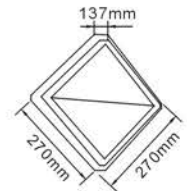

● **ALED-122C**

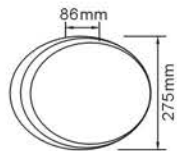

● **ALED-123A**

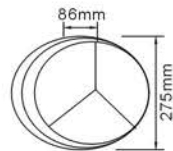

● **ALED-123B**

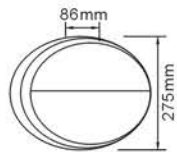

● **ALED-123C**

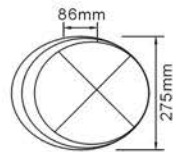

● **ALED-123D**



Energy Saving Bulkhead

- Material: Stainless Steel Cover + PC Body
- Lamp: E27 / 10W LED Bulb or 14W Energy Saving Bulb (Bulb Excluded)
- Finish: Stainless Steel / Silver Grey / Dark Grey / Black
- IP44

CE  RoHS
EMC

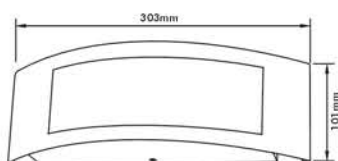

● AL-168A

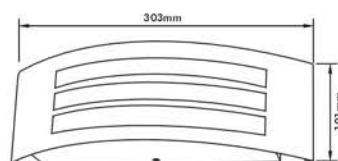
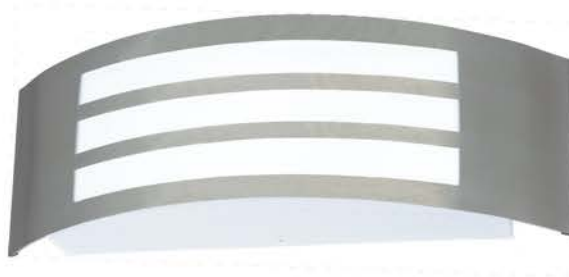

● AL-168B

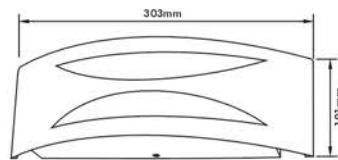

● AL-168C

LED Exterior Bulkhead - AC type (driverless)



CE EMC

DEKRA RoHS

- Material: ABS Base + PC Diffuser + PP Frame
- Voltage: AC 220V ~ 240V
- Color Temperature: 2700K ~ 6500K
- CRI: Ra>80
- Finish: Black Frame + White Diffuser
- IP54

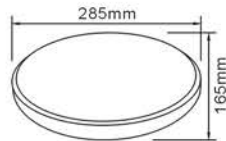

● ALED-523C ● ALED-523D

●	Lamp	Lumen	Product size
ALED-523C	8.4W (26 x 0.32W SMD2835 LED)	500LM (4000K)	L: 28.5 x W: 16.5 x H: 9.9cm
ALED-523D	8.4W (26 x 0.32W SMD2835 LED)	500LM (4000K)	L: 28.5 x W: 16.5 x H: 9.9cm

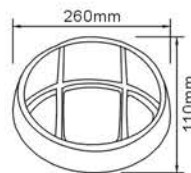

●	Lamp	Lumen	Product size
ALED-525A	4.7W (12 x 0.39W SMD2835 LED)	230LM (4000K)	Dia. 17 x H. 7.3cm
ALED-M525A	8.9W (24 x 0.37W SMD2835 LED)	500LM (4000K)	Dia. 26 x H. 11cm

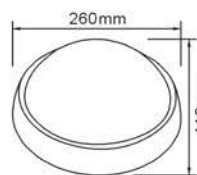

●	Lamp	Lumen	Product size
ALED-525C	4.7W (12 x 0.39W SMD2835 LED)	230LM (4000K)	Dia. 17 x H. 7.3cm
ALED-M525C	8.9W (24 x 0.37W SMD2835 LED)	500LM (4000K)	Dia. 26 x H. 11cm

●	Lamp	Lumen	Product size
ALED-525D	4.7W (12 x 0.39W SMD2835 LED)	230LM (4000K)	Dia. 17 x H. 7.3cm
ALED-M525D	8.9W (24 x 0.37W SMD2835 LED)	500LM (4000K)	Dia. 26 x H. 11cm

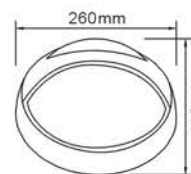

●	Lamp	Lumen	Product size
ALED-525E	4.7W (12 x 0.39W SMD2835 LED)	230LM (4000K)	Dia. 17 x H. 7.3cm
ALED-M525E	8.9W (24 x 0.37W SMD2835 LED)	500LM (4000K)	Dia. 26 x H. 11cm

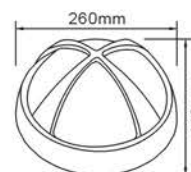

Aluminum Bulkheads

- Material: Die Cast Aluminum + Glass
- Finish: White/Black
- IP44



● **AL-512** E27 10W LED Bulb A type 

205mm | 315mm — 130mm |

● **AL-512S** E27 5W LED Bulb G45 type 

140mm | 210mm — 108mm |

● **AL-514** E27 10W LED Bulb A type 

205mm | 315mm — 130mm |

● **AL-514S** E27 5W LED Bulb G45 type 

140mm | 210mm — 108mm |

● **AL-520** E27 10W LED Bulb A type 

260mm | 260mm — 100mm |

● **AL-520S** E27 5W LED Bulb G45 type 

190mm | 190mm — 94mm |

● **AL-522** E27 10W LED Bulb A type 

260mm | 260mm — 110mm |

● **AL-522S** E27 5W LED Bulb G45 type 

190mm | 190mm — 106mm |

● **AL-524** E27 10W LED Bulb A type 

260mm | 260mm — 110mm |

● **AL-524S** E27 5W LED Bulb G45 type 

















190mm | 190mm — 106mm |

● **AL-533** E27 10W LED Bulb A type 

185mm | 280mm — 110mm |

Aluminum Bulkheads

- Material: Die Cast Aluminum + Glass
- Finish: White/Black
- IP44

<p>● AL-301 E27 10W LED Bulb A type </p> <p>240mm 240mm — 125mm </p> <p>● AL-301S E27 5W LED Bulb G45 type </p> <p>180mm 180mm — 100mm </p>
<p>● AL-303 E27 10W LED Bulb A type </p> <p>240mm 240mm — 115mm </p> <p>● AL-303S E27 5W LED Bulb G45 type </p> <p>180mm 180mm — 95mm </p>
<p>● AL-306 E27 10W LED Bulb A type </p> <p>240mm 240mm — 125mm </p> <p>● AL-306S E27 5W LED Bulb G45 type </p> <p>180mm 180mm — 100mm </p>
<p>● AL-232 E27 10W LED Bulb A type </p> <p>160mm 280mm — 135mm </p> <p>● AL-232S E27 5W LED Bulb G45 type </p> <p>180mm 213mm — 102mm </p>
<p>● AL-236 E27 10W LED Bulb A type </p> <p>160mm 280mm — 135mm </p> <p>● AL-236S E27 5W LED Bulb G45 type </p> <p>108mm 213mm — 102mm </p>
<p>● AL-238 E27 10W LED Bulb A type </p> <p>160mm 280mm — 128mm </p> <p>● AL-238S E27 5W LED Bulb G45 type </p> <p>108mm 213mm — 97mm </p>
<p>● AL-239 E27 10W LED Bulb A type </p> <p>160mm 280mm — 135mm </p> <p>● AL-239S E27 5W LED Bulb G45 type </p> <p>108mm 213mm — 102mm </p>
<p>● AL-510 E27 10W LED Bulb A type </p> <p>205mm 315mm — 120mm </p> <p>● AL-510S E27 5W LED Bulb G45 type </p> <p>140mm 210mm — 100mm </p>

Aluminum Bulkheads

- Material: Die Cast Aluminum
- Bulb Adaptable: E27 10W LED Bulb A type 
- Finish: White/Black
- IP44

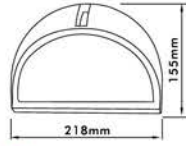

● **AL-130**



- Material: Die Cast Aluminum
- Bulb Adaptable: E27 10W LED Bulb A type 
- Finish: White/Black
- IP44

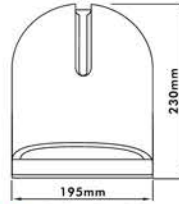

● **AL-160**



- Material: Die Cast Aluminum
- Bulb Adaptable: E27 5W LED Bulb G45 type 
- Finish: White/Black
- IP44

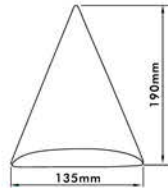

● **AL-140**



● **AL-150**

- Material: Die Cast Aluminum
- Bulb Adaptable: E27 5W LED Bulb G45 type 
- Finish: White/Black
- IP44

Aluminum Bulkheads

- Material: Die Cast Aluminum
- Bulb Adaptable: E27 10WLED Bulb A type 
- Finish: Black/White
- IP44



● AL-036



● AL-037



● AL-038

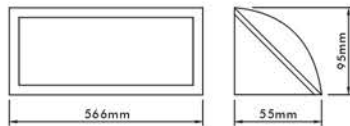

Exterior Step Light

Home Resource 2017 Collection

Waterproof AC type Plastic LED Brick Light -Super Slim Surface-Mount design

EMC CE SAA APPROVALS*

- Material: ABS Body + PC Diffuser
- Voltage: AC 220V ~ 240V
- Color Temperature: 4000K ~ 6500K
- CRI: RA \geq 80
- Finish: Black / Grey / White
- IP65



Surface-Mount

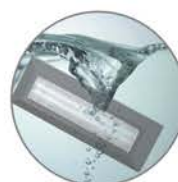

Waterproof



Super Slim

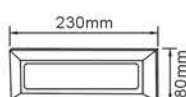

● SMLED-580

1.8W (30pcs x 0.06W SMD3014 LED)
190LM (4000K)

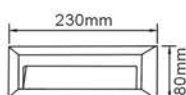

● SMLED-581

2.1W (35pcs x 0.06W SMD3014 LED)
90LM (4000K)

● SMLED-588

0.5W (9pcs x 0.06W SMD3014 LED)
25LM (4000K)

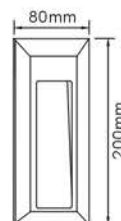

● SMLED-582

2.7W (45pcs x 0.06W SMD3014 LED)
250LM (4000K)

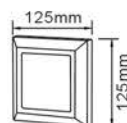

● SMLED-583

1W (16pcs x 0.06W SMD3014 LED)
50LM (4000K)

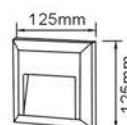

● SMLED-584

2.4W (40pcs x 0.06W SMD3014 LED)
220LM (4000K)

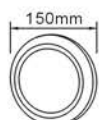

● SMLED-585

1.2W (20pcs x 0.06W SMD3014 LED)
60LM (4000K)

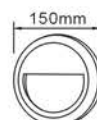

Aluminum Bulkheads Step Light

- Material: Die Cast Aluminum
- Bulb Adaptable: E27 5W LED Bulb G45 type 
- Finish: Black/White
- IP44

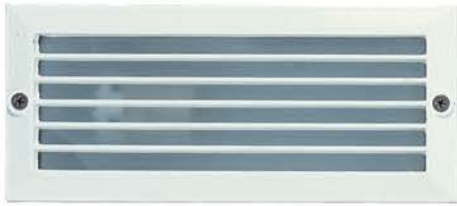

● **RL-20A**

100mm | 233mm — 77mm |



● **RL-20C**

100mm | 233mm — 77mm |

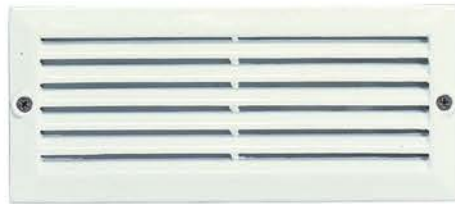

● **RL-20B**

100mm | 233mm — 77mm |



Exterior

LED Tri Proof Light

Home Resource 2017 Collection

LED Tri Proof Light

- Material: Plastic + Aluminum
- Voltage: 85V ~ 265V
- Color Temperature: 3000K ~ 6000K
- Finish: White
- IP65



● **EFLED-400**

●	Lamp	Lumen	Product size
EFLED-400(18W)	18W (96pcs x SMD2835 LED)	1710LM(4000K)	L. 65 x W. 5.8 x H. 3.5cm
EFLED-400(36W)	36W (196pcs x SMD2835 LED)	3420LM(4000K)	L. 125 x W. 5.8 x H. 3.5cm
EFLED-400(45W)	45W (240pcs x SMD2835 LED)	4275LM(4000K)	L. 155 x W. 5.8 x H. 3.5cm



LED Tri Proof Light

- Material: Plastic + Aluminum
- Voltage: 85V ~ 265V
- Color Temperature: 3000K ~ 6000K
- Finish: White
- IP65



EFLED-600A series is Optional
-With openable cap to ease the
wire connection

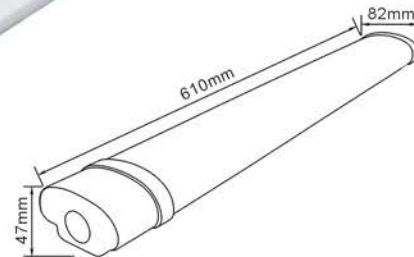

● EFLED-600

●	Lamp	Lumen	Product size
EFLED-600(18W)	18W (96pcs x SMD2835 LED)	1710LM(4000K)	L. 61 x W. 8.2 x H. 4.7cm
EFLED-600(36W)	36W (196pcs x SMD2835 LED)	3420LM(4000K)	L. 121 x W. 8.2 x H. 4.7cm
EFLED-600(45W)	45W (240pcs x SMD2835 LED)	4275LM(4000K)	L. 151 x W. 8.2 x H. 4.7cm
EFLED-600(30W)	30W (96pcs x SMD2835 LED)	2850LM(4000K)	L. 61 x W. 8.2 x H. 4.7cm
EFLED-600(60W)	60W (176pcs x SMD2835 LED)	5700LM(4000K)	L. 121 x W. 8.2 x H. 4.7cm
EFLED-600(70W)	70W (240pcs x SMD2835 LED)	6650LM(4000K)	L. 151 x W. 8.2 x H. 4.7cm



Interior Decorative Light

Home Resource 2017 Collection

LED Table/Floor Lamp-Lover

- Material: Stainless Steel Base + Aluminum Spot Head + Aluminum & Acrylic Strip
- Finish: Chrome

Patented

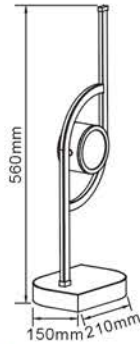

● TLED-645

Lamp: 12W+5W (108pcs SMD2835 LED for Decorative Light + COB 5W LED for Spot Light)

With Built-in Driver
4-Way Line Switch

(Spot Light On - Decorative Light On - Both Lights On - Off)

Lumen (for 4000K): 800LM for Decorative Light
+ 350LM for Spot Light

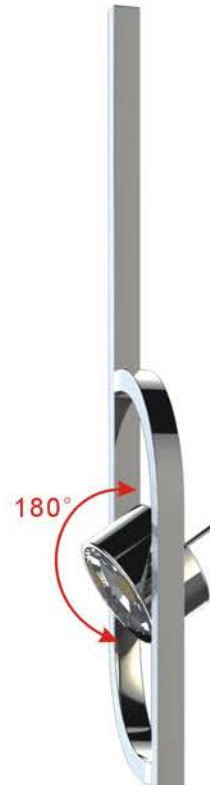

● FLKLED-645

Lamp: 22W+5W (234pcs SMD2835 LED for Decorative Light + COB 5W LED for Spot Light)

With Built-in Driver
4-Way Foot Switch

(Spot Light On - Decorative Light On - Both Lights On - Off)

Lumen (for 4000K): 1500LM for Decorative Light
+ 350LM for Spot Light

LED Interior Ceiling/Wall Lamp-Lover

- Material: Stainless Steel Base + Aluminum Spot Head + Aluminum & Acrylic Strip
- Finish: Chrome

• Patented

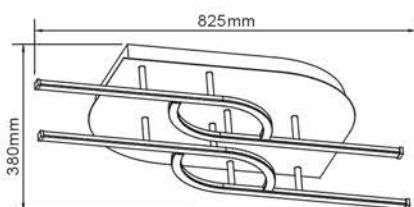
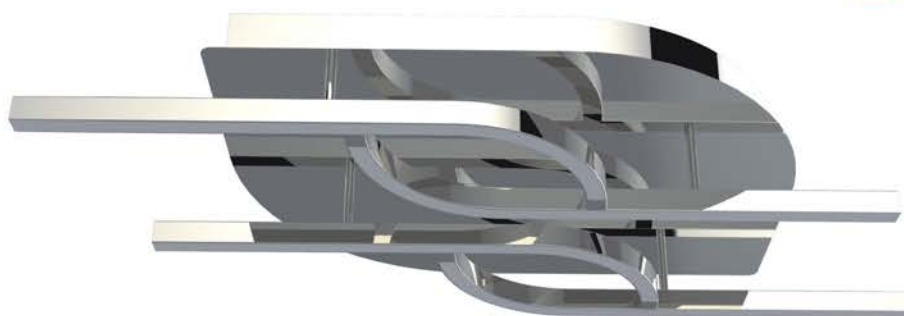

● **CMLED-645-2**

Lamp: 27W (252pcs SMD2835 LED)
With Built-in Driver
Lumen: 1850LM (4000K)

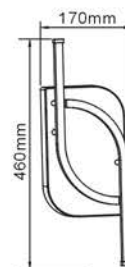

● **WLED-645**

Lamp: 9W (86pcs SMD2835 LED)
With Built-in Driver
Lumen: 550LM (4000K)
Stainless Steel Mounting Plate

LED Dining Lamp-Lover

- Material: Stainless Steel Base + Aluminum Spot Head + Aluminum & Acrylic Strip
- Finish: Chrome

Patented

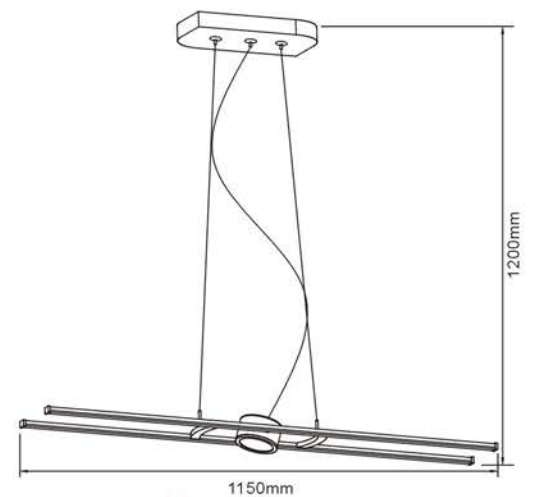

● HGLED-645

Lamp: 27W+5W (270pcs SMD2835 LED for Decorative Light + COB 5W LED for Spot Light)
With Built-in Driver
Lumen (for 4000K): 1850LM for Decorative Light + 350LM for Spot Light
Cable length is adjustable, Max. up to 1200mm

LED Table/Floor Lamp-Coral

- Material: Stainless Steel & Steel Base + Aluminum & Acrylic Strip
- Finish: Chrome

Patented



● **FLKLED-646**

Lamp: 15W (132pcs SMD2835 LED)
With Built-in Driver
Foot On/Off Switch
Lumen: 980LM (4000K)



● **TLED-646**

Lamp: 9W (72pcs SMD2835 LED)
With Built-in Driver
Line On/Off Switch
Lumen: 500LM (4000K)



LED Interior Ceiling/Wall Lamp-Coral

- Material: Stainless Steel & Steel Base + Aluminum & Acrylic Strip
- Finish: Chrome

Patented

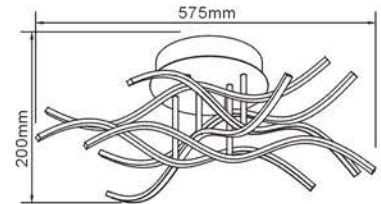
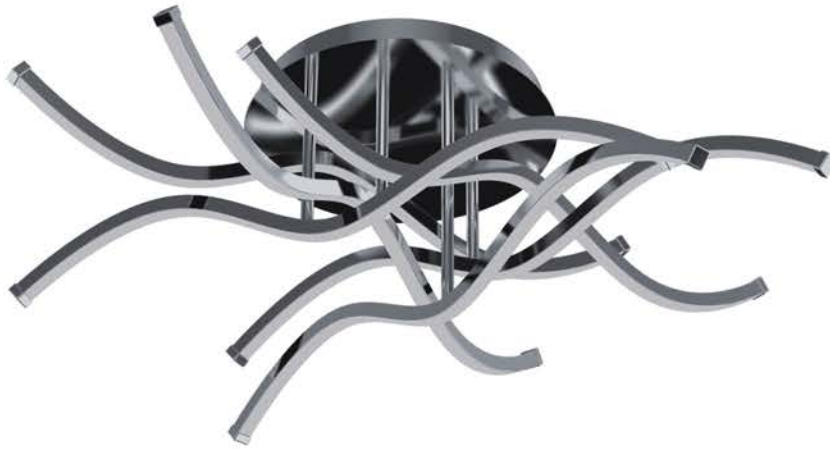

● CMLED-646-6

Lamp: 36W (396pcs SMD2835 LED)
With Built-in Driver
Lumen:2500LM(4000K)

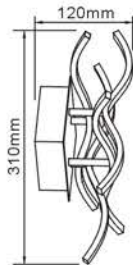

● WLED-646

Lamp: 9W (96pcs SMD2835 LED)
With Built-in Driver
Lumen:550LM(4000K)
Stainless Steel Mounting Plate



LED Dining Lamp-Coral

- Material: Stainless Steel & Steel Base + Aluminum & Acrylic Strip
- Lamp: 36W (396pcs SMD2835 LED)
- With Built-in Driver
- Lumen:2500LM(4000K)
- Cable length is adjustable,Max.up to1200mm
- Finish: Chrome

• Patented

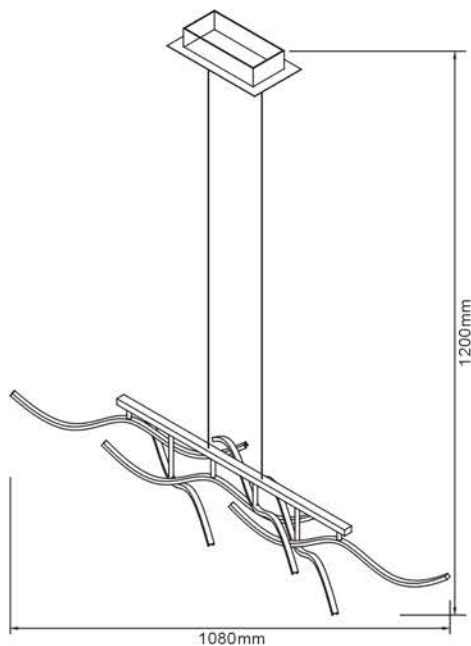

● HGLD-646-6



LED Table/Floor Lamp-Pisces

- Material: Stainless Steel & Steel Base + Aluminum & Acrylic Strip
- Finish: Chrome

Patented

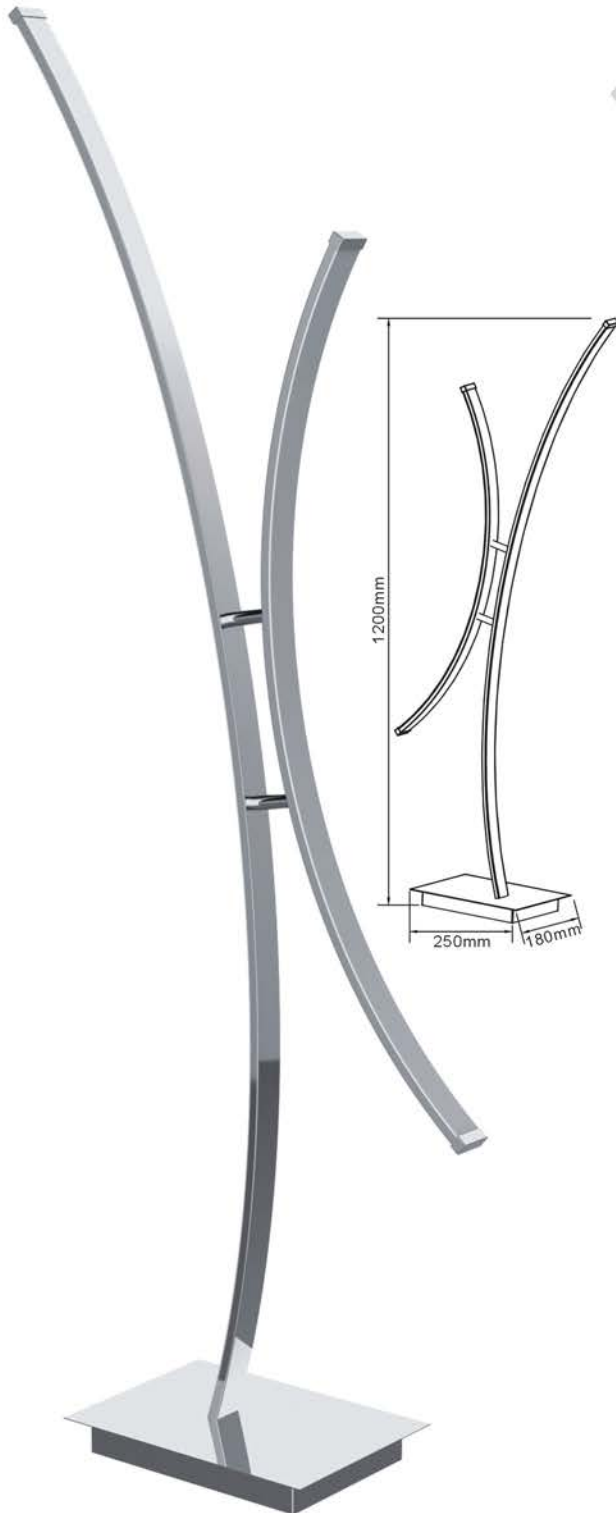

FLKLED-647

Lamp: 17W (456pcs SMD2835 LED)
With Built-in Driver
Foot On/Off Switch
Lumen: 1100LM(4000K)

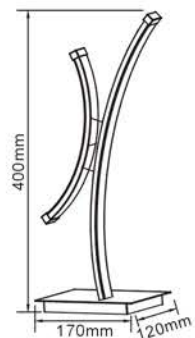

TLED-647

Lamp: 12W (144pcs SMD2835 LED)
With Built-in Driver
Line On/Off Switch
Lumen: 550LM (4000K)



LED Interior Ceiling/Wall Lamp-Pisces

- Material: Stainless Steel & Steel Base + Aluminum & Acrylic Strip
- Finish: Chrome

• Patented

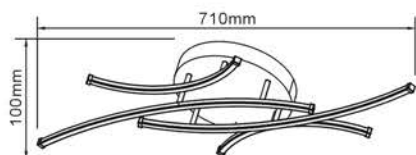

● **CMLED-647**

Lamp: 21W (198pcs SMD2835 LED)
With Built-in Driver
Lumen:1540LM(4000K)

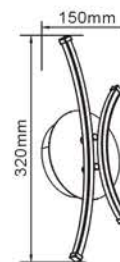

● **WLED-647**

Lamp: 12W (64pcs SMD2835 LED)
With Built-in Driver
Lumen:800LM(4000K)
Stainless Steel Mounting Plate



LED Dining Lamp-Pisces

- Material: Stainless Steel & Steel Base + Aluminum & Acrylic Strip
- Lamp: 21W (306pcs SMD2835 LED)
- With Built-in Driver
- Lumen: 1450LM(4000K)
- Cable length is adjustable, Max. up to 1200mm
- Finish: Chrome

Patented

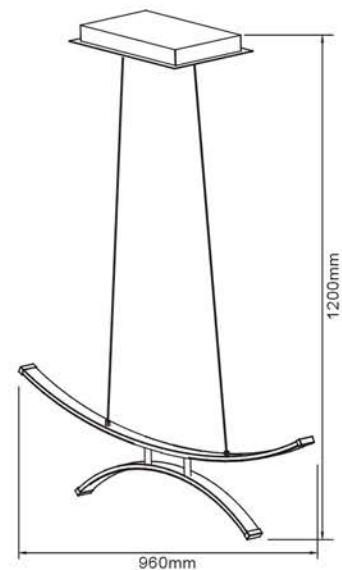

● HGLED-647

LED Wall/Table/Floor Lamp-Flyer

- Material: Zinc Alloy + Iron + PMMA (+ Stainless Steel)
- Finish: Matt Black

• Patented



Rotate 110 degrees

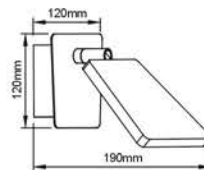

● WLED-326

With 4.8W (24pcs x 0.2W SMD2835 LED)
With Built-in Driver
Lumen: 268LM (4000K)
Stainless Steel Mounting Plate



Rotate 120 degrees



● TLED-326-2

With 2 Lights x 4.8W (24pcs x 0.2W SMD2835 LED per Light)
With Driver and 1.5m Cable + Line Switch
Lumen: 388LM (4000K)
Lux: 1100Lux (H. 30cm)



● FLED-326-2

With 2 Lights x 4.8W (24pcs x 0.2W SMD2835 LED per Light)
With Driver and 1.8m Cable + Foot Switch
Lumen: 388LM (4000K)

LED Dining Lamp-Flyer

- Material: Zinc Alloy + Iron + PMMA (+ Stainless Steel)
- With 6 Lights x 4.8W (24pcs x 0.2W SMD2835 LED per Light)
- With Built-in Driver
- Lumen: 1100LM (4000K)
- Cable length is adjustable, Max. up to 800mm
- Finish: Matt Black

Patented



LED Interior Ceiling Lamp

- Material: Steel + Aluminum + PC
- Voltage: 220V ~ 240V
- Finish: Chrome Body + White Diffuser

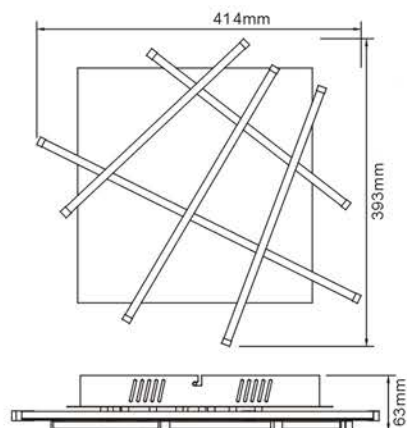

● CMLED224-5

Lamp: 30W (219pcs x SMD2835 LED)
Lumen: 1250LM (4000K)

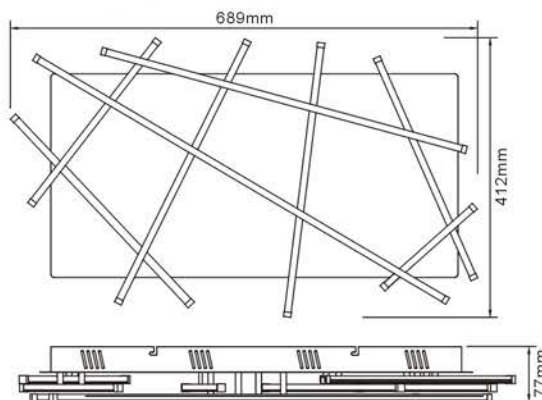

● CMLED224-8

Lamp: 42W (393pcs x SMD2835 LED)
Lumen: 2500LM (4000K)

Interior Hanging Lamp

- Material: Steel (+Wood)
- Bulb Adaptable: E27 6W LED Bulb 
- Finish: Black/Golden



Interior Hanging Lamp

- Material: Steel Canopy + Ply-wood Shade
- Bulb Adaptable: E27 6W LED Bulb
- Color: Dark Brown / Natural Ply-wood Color



● **HG-306A**



● **HG-306B**



● **HG-307A**



● **HG-307B**



● **HG-308A**



● **HG-308B**



Touch Sensor Lamp

- Material: Iron + Fabric Lampshade
- Bulb Adaptable: E14 5W LED Bulb
- With Touch Sensor

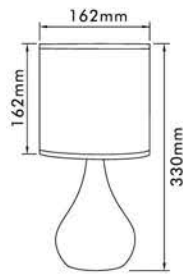

● **DT-118**

Finish: Satin Nickel/Chrome

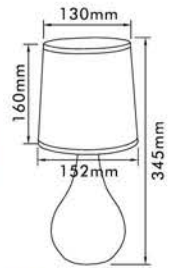

● **DT-117**

Finish: Gun Metal Plated + Black Shade

- Material: Iron + Fabric Lampshade
- Bulb Adaptable: E27 10W LED Bulb
- Finish: Chrome/Satin Nickel/Gum Metal

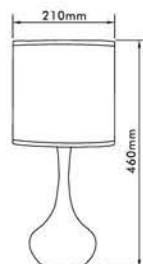

● **DT-1103**

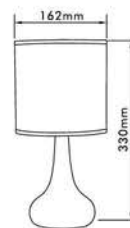

● **DT-1102**

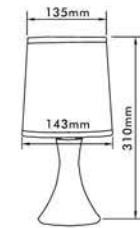

● **DT-1101**

Interior Hanging Lamp

- Material: Steel Body + Glass Diffuser
- Bulb Adaptable: E27 6W LED Bulb
- Finish: Black Body + Amber Glass



● ● HG-290



● ● HG-291



● ● HG-292

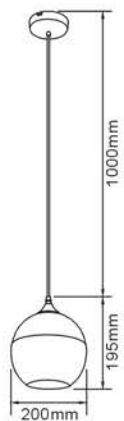

● ● HG-368



Interior Hanging Lamp



● **HG-946**
Material: Steel + Aluminum + Braided Wire
Bulb Adaptable: E27 6W LED Bulb
Finish: Pearl Black / Antique Brass / Copper



Optional Bulbs



E27T64FLED-6W (Clear / Amber)



E27G125FLED-6W (Clear / Amber)

● **HG-947**
Material: Aluminum + PVC Wire
Bulb Adaptable: E27 6W LED Bulb
Finish: Antique Brass / Copper



● **HG-948**
Material: Aluminum + PVC Wire
Bulb Adaptable: E27 6W LED Bulb
Finish: Copper / Antique Brass



● **HG-940**
Material: Steel + Aluminum + Braided Wire
Bulb Adaptable: E27 6W LED Bulb
Finish: Copper / Antique Brass / Pearl Black

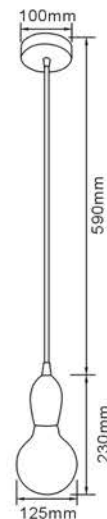

Interior Hanging Lamp

- Material: Steel + Braided Wire
- Bulb Adaptable: E27 6W LED Bulb
- Finish: Blue / Yellow / White / Red / Black



● **HG-949**



Optional Bulbs



E27 UFOLED-18WG1
DIA125mm



E27 UFOLED-24WG1
DIA155mm



E27 UFOLED-36WG1
DIA185mm

Interior Hanging Lamp

- Bulb Adaptable: E27 10W LED Bulb
- Finish: White/Glossy Black/Matt Silver/
Transparent red/Brown/Grey

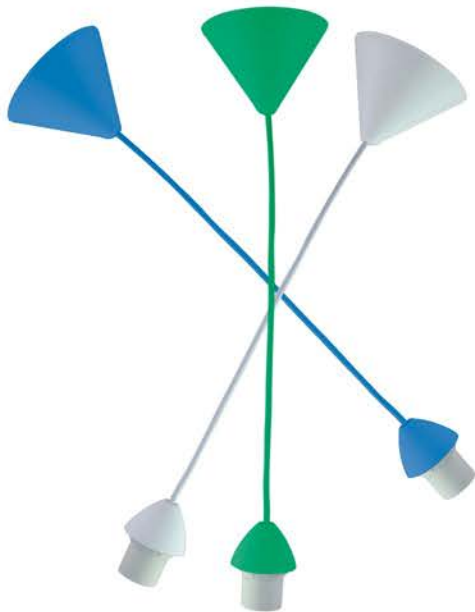

● **HG-931A**
Material: **PP** + Braided Wire

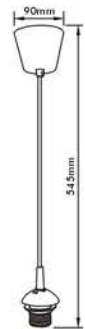

● **HG-930C**
Material: **PP** + Braided Wire



● **HG-932A**
Material: **Ceramic** L/H housing + braided wire + PP

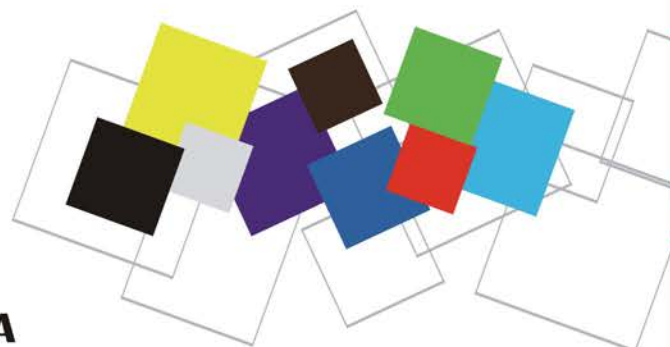

Interior Hanging Lamp

- Bulb Adaptable: E27 10W LED Bulb
- Finish: Black/White/Green/Orange/Red/Blue/
Yellow/Purple/Brown

Canopy A
(Dia. 125mm)



Canopy B
(Dia. 70mm)



Canopy C
(Top dia. 90mm)

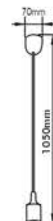

● **HG-024A** ● **HG-024B** ● **HG-024C**

Material: **Silicon** Rubber L/H housing + braided wire + PP



**Exclusive
for West
Europe**

● **HG-933C**

Material: **ABS** L/H housing + braided wire + PP

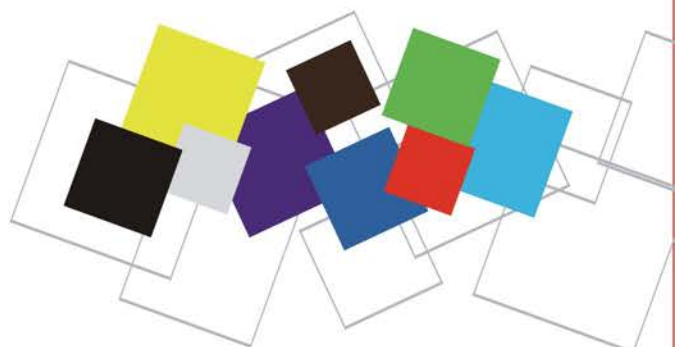

Interior Hanging Lamp

- Material: Aluminum + Steel + Glass
- Bulb Adaptable: E27 6W LED Bulb 
- Finish: Chrome / Satin Nickel Body + White Glass

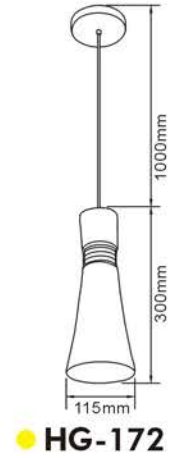
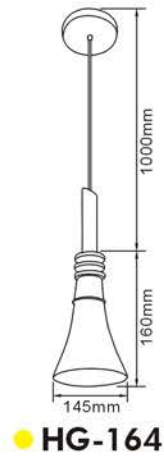

Glass Pendant

- Material: Pressed Iron + Glass
- Bulb Adaptable: E27 10W LED Bulb + A Type 

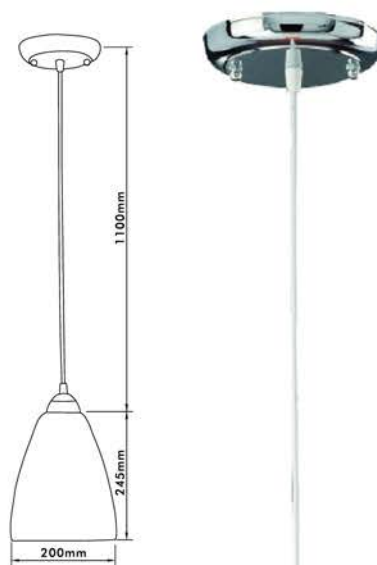

● ● HG-020



Crystal Ceiling Lamp

- Material: Steel + Crystal
- Finish: Chrome Body + Transparent Crystal

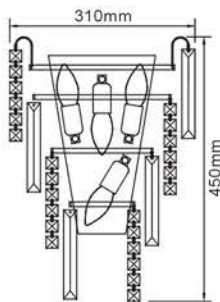

● **WLK205-4**

Bulb Adaptable: 4 x E14 6W LED Bulb

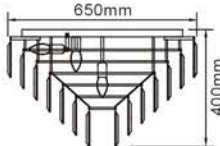

● **HG-313-15**

Bulb Adaptable: 15 x E14 6W LED Bulb

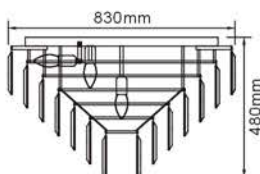

● **HG-L313-21**

Bulb Adaptable: 21 x E14 6W LED Bulb

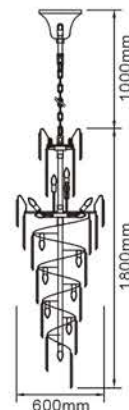

● **HG-312-27**

Bulb Adaptable: 27 x E14 6W LED Bulb

Crystal Pendant Lamp

- Material: Steel + Crystal
- Finish: Chrome Body + Transparent Crystal

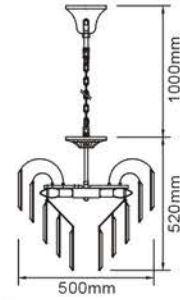

● **HG-S311-6**

Bulb Adaptable: 6 x E14 6W LED Bulb

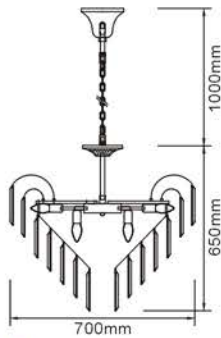

● **HG-311-15**

Bulb Adaptable: 15 x E14 6W LED Bulb

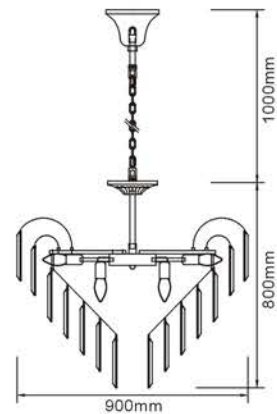

● **HG-L311-21**

Bulb Adaptable: 21 x E14 6W LED Bulb

Interior Mood Light & Novelty Light

Home Resource 2017 Collection

Rechargeable LED Mood Light-Magic Cube

- Material: PMMA Body + Steel Base
- Lamp: 1.68W(12 x 0.14W SMD5050 RGBW LED)
- Power Consumption: 2.2W
- Luminous Flux(6000k): white light(50%)-18LM/RGB/white light(100%)-36LM
- 4-Way Touch switch: white light(50%)-RGB-white light(100%)-Off
- Operation Time: 3.5H(white light 100%/RGB)/9H(white light 50%)
- With 1pc Built-in 3.7V 2000mAh 18650 Lithium Rechargeable battery
- (Fully Charge 8H ; 500 circles)
- Power On by USB directly after battery finishing up its life
- Finish: Satin Nickel/Chrome

Patented



With 1.2M Micro USB Connection Cable



1pc 18650 Lithium Rechargeable battery 2000mAh (Incl.)

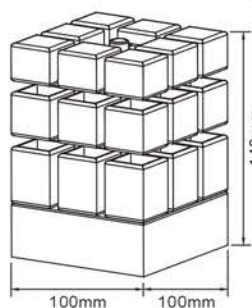

● ETLED-069B



4-Way Touch Switch



Rechargeable LED Mood Light-Sunflower

- Material: Steel + PMMA Diffuser
- Lamp: 2.1W(15 x0.14W SMD5050 RGBW LED)
- Power Consumption: 2.8W
- Luminous Flux(6000k):white light(50%)-22LM/RGB/white light(100%)-44LM
- 4-Way Touch switch: white light(50%)-RGB-white light(100%)-Off
- Operation Time:3H(white light100%/RGB)/8H(white light50%)
- With 1pc Built-in 3.7V 2000mAh 18650 Lithium Rechargeable battery
- (Fully Charge 8H ; 500 circles)
- Power On by USB directly after battery finishing up its life
- Finish: Satin Nickel/Chrome

Patented



With 1.2M Micro USB Connection Cable



1pc 18650 Lithium Rechargeable battery 2000mAh (Incl.)

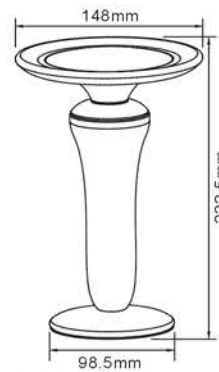

4-Way Touch Switch

ETLED-51B



Rechargeable LED Mood Light-Torch

- Material: ABS Body + PMMA Diffuser
- Lamp: 0.25W (42 x 0.06W SMD0603 LED) - Flashing flames light on partially and continually
- Touch On/Off Switch
- With 1 pc Built-in 3.7V 1200mAh 18650 Lithium Rechargeable battery
- Power on by USB directly after battery finishing up its life
- Operation Time: 20-24H
- (Fully charge 4H: 500 circles)
- With 1.2M USB Connection Cable+DC hole
- Finish: Dark Wood / Light Wood / Bronze

Patented



light wood



dark wood



Bronze



USB Cable

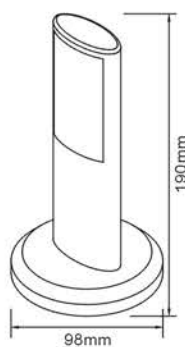

ETLED-32



1pc 18650 Lithium Rechargeable battery 1200mAH(Incl.)



Rechargeable LED Mood Light-Torch

- Material: ABS Body + PMMA Diffuser
- Lamp: 0.5W (2 x 42 x 0.06W SMD0603 LED) - Flashing flames light on partially and continually
- Touch On/Off Switch
- With 1pc Built-in 3.7V 1600mAh 18650 Lithium Rechargeable battery
- Power on by USB directly after battery finishing up its life
- Operation Time: 18-20H
- (Fully charge 8H:500 circles)
- With 1.2M USB Connection Cable+DC hole
- Finish: Dark Wood / Light Wood / Bronze

Patented



USB Cable



1pc 18650 Lithium Rechargeable battery 1600mAh (Incl.)



light wood



dark wood



Bronze

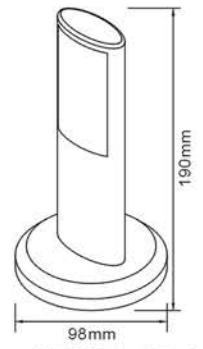

ETLED-32A

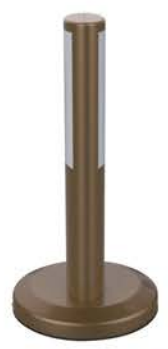

Battery Operated Sensor Light-Robot

- Material: ABS Body + PC Diffuser
- Lamp: 2 x 0.5W SMD5630 Modules
- Power consumption: 0.8W
- Luminous flux: 25 LM (4000K) ; 30 LM (6000K)
- Finish: White
- Battery: 3 x AAA(Excl.)
- Battery Working Time at "ON" mode: 8H
- With 3 Section Slide Switch: Motion Sensor - OFF - ON
- Motion Sensor: 2M, 120 ° , Time Delay (18Sec+/-5Sec)

Patented

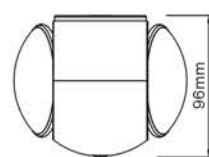
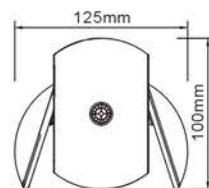

BO-LED74



Motion sensor-Off-On



Battery cover



Battery Operated LED *Tulip* Lamp Deluxe Tulip (Alkaline-Battery Version)

- Material: Steel Top & Base + Alu. Body + PMMA Diffuser
- Lamp: 1.38W(23x0.06W Φ 5 LED)
- Luminous Flux (6000K): Low (20%) - 8LM / Medium (50%) - 46LM / High (100%) - 86LM
- 4-Way Touch Switch: Low (20%) - Medium (50%) - High (100%) - Off
- Off Delay: 4H (If the switch is not closed, will automatically shut down after 4 hours)
- Operation Time: 18-86H(Alkaline Batteries)
- Finish: Satin Nickel/Chrome

Patented

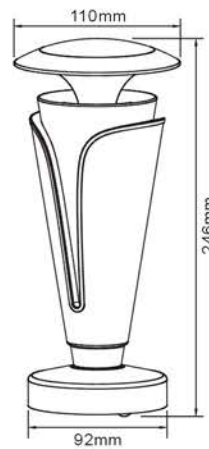

ETLED-50A



USB Cable



AC-USB Adaptor
I/P 100-240V AC 50/60Hz
O/P 5V DC 500mA



Battery: 3 x AA(Excl.)



4-Way Touch Switch



Satin Nickel



Chrome

Battery Operated LED *Tulip* Lamp Bloomy Tulip (Alkaline-Battery Version)

- Material: ABS Top/Body/Base + PMMA Diffuser
- Lamp: 1.38W(23x0.06W Φ 5 LED)
- Luminous Flux (6000K): Low (20%) - 8LM / Medium (50%) - 46LM / High (100%) - 86LM
- 4-Way Touch Switch: Low (20%) - Medium (50%) - High (100%) - Off
- Off Delay: 4H (If the switch is not closed, will automatically shut down after 4 hours)
- Operation Time: 18-86H(Alkaline Batteries)
- Finish: Painting Black/White/Blue/Green/Pink/Orange

Patented



Option 1



USB Cable

Option 2



AC-USB Adaptor
I/P 100-240V AC 50/60Hz
O/P 5V DC 500mA



Battery: 3 x AA(Excl.)



4-Way Touch Switch



Painting Black



White



Blue



Green



Pink



Orange

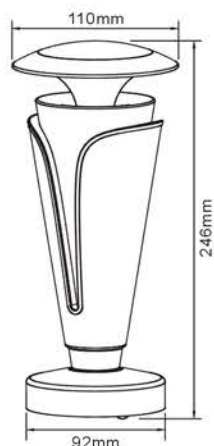

ETLED-50AP

Rechargeable LED *Tulip* Lamp

- Deluxe Tulip

Patented

- Material: Steel Top & Base + Alu. Body + PMMA Diffuser
- Lamp: 2.1W(15 x0.14W SMD5050 LED)
- Power Consumption: 2.8W
- Luminous Flux (6000K): Low (20%) - 16LM / Medium (50%) - 56LM / High (100%) - 120LM
- 4-Way Touch Switch: Low (20%) - Medium (50%) - High (100%) - Off
- Operation Time: 3H (100%) / 8H (50%) / 25H (20%)
- With 1pc Built-in 3.7V 2000mAh 18650 Lithium Rechargeable battery
- (Fully Charge 8H ; 500 circles)
- Power On by USB directly after battery finishing up its life
- Finish: Satin Nickel/Chrome



With 1.2M Micro USB Connection Cable



1pc 18650 Lithium Rechargeable battery 2000mAh (Incl.)



4-Way Touch Switch



ETLED-50B



Satin Nickel



Chrome



Rechargeable LED *Tulip* Lamp

- Bloomy Tulip

Patented

- Material: ABS Top/Body/Base + PMMA Diffuser
- Lamp: 2.1W(15 x0.14W SMD5050 LED)
- Power Consumption: 2.8W
- Luminous Flux (6000K): Low (20%) - 16LM / Medium (50%) - 56LM / High (100%) - 120LM
- 4-Way Touch Switch: Low (20%) - Medium (50%) - High (100%) - Off
- Operation Time: 3H (100%) / 8H (50%) / 25H (20%)
- With 1pc Built-in 3.7V 2000mAh 18650 Lithium Rechargeable battery
- (Fully Charge 8H ; 500 circles)
- Power On by USB directly after battery finishing up its life
- Finish: Painting Black/White/Blue/Green/Pink/Orange



With 1.2M Micro USB Connection Cable



1pc 18650 Lithium Rechargeable battery 2000mAh (Incl.)



4-Way Touch Switch

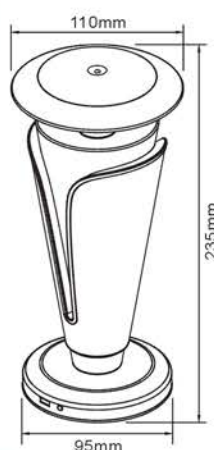

ETLED-50BP



Painting Black



White



Blue



Green



Pink



Orange



LED Mood Lamp-Mini

Patented

- Material: PP+ABS
- Lamp: 0.8W (4 x 0.2W SMD5050 RGB LED)
- Finish: P.White/P.Pink/P.Orange/P.Blue/Black/Silver
- Battery: 3 x AA (Excl.)
- Operating Time: >30H (Alkaline Batteries)



Battery: 3 x AA(Excl.)



USB Cable



AC-USB Adaptor
I/P 100-240V AC 50/60Hz
O/P 5V DC 500mA

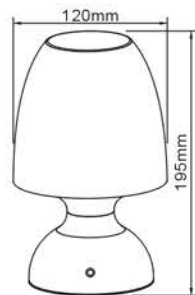

ETLED-20R/R1



Silver



P.Pink



Black



P.White



LED Table Lamp-**Mini**

Patented

- Material: PP Shade + ABS Base
- Lamp: 0.72W (12x0.06W Φ 5 LED)
- Luminous flux: 60Lm(6000K)
- Finish: White/Black
- Battery: 3 x AA (Excl.)
- Operating Time: 36H (Alkaline Batteries)
- With Touch Switch on Base



Battery: 3 x AA(Excl.)



USB Cable



AC-USB Adaptor
I/P 100-240V AC 50/60Hz
O/P 5V DC 500mA



Black



White



ETLED-20T/T1

ETLED-20TC/TC1 : With blue indicator
ETLED-20T/T1 : W/O blue indicator



LED Mood Light-Mini

- Material: ABS
- AC Type
- Voltage: 220V ~ 240V
- Lamp: 2.5W (7 x SMD2835 LED)
- Lumen: 230LM (4000K)
- With 1.5M Cable + VDE Plug
- Line On/Off Switch
- Color: White/Blue/Rose/Green/Light Purple

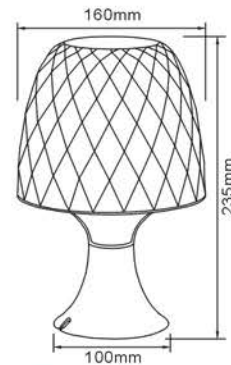

● **ETLED-064**



LED Sensor Mood Light

- Material: ABS
- Lamp: 6 x $\Phi 5$ 6000K LED + 6 x $\Phi 5$ 3000K LED
- Battery Working Time: 20H (4 x C excl.)
- Lumen: 45LM (3000K) / 100LM (6000K)
- 4-Section Slide-Switch: Night Light (3000K LED) - OFF -
Daylight (6000K LED) - Auto (6000K LED for sensor)
- Motion Sensor: 120° , 45Sec. 4~5M
- Color: White / Red / Purple / Blue

CE EMC  RoHS



4-Section Slide-Switch

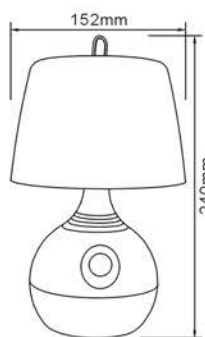

● ETLED-065S



LED Storage Lamp

Patented

- Material: PP Shade + ABS Base
- Lamp: 1.44W (24 x 0.06W Φ 5 LED)
- Luminous flux: 68Lm(4000K)
- Finish: White + Chrome/Black + Chrome
- With On/Off/Sensor Switch on Base (Sensor Range 120°)
- Operating Time: >18H (Alkaline Batteries)



Battery: 4 x AA(Excl.)



USB Cable



AC-USB Adaptor
I/P 100-240V AC 50/60HZ
O/P 5V DC 500mA

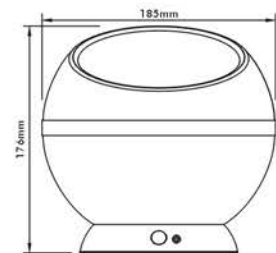

● KLED-88



LED Mood Light with Torch

- Material: ABS + PS
- Lamp: 0.2W (1 x 0.2W SMD2835 LED)
- Battery Working Time: 10H (3 x AAA Excl.)
- Switch: On/Off Switch
- Color: White



LED Mushroom Lamp

Patented



reddot design award
winner 2008



GOOD DESIGN PRODUCT



ETLED-18BTC

Material: Iron Top & Body + PMMA Diffuser
Lamp: 12 x 0.06W Φ 5 LED Modules
Luminous flux: 60Lm(6000K)
With 1pc Built-in 3.7V 4800mAh 18650 Lithium Rechargeable battery
Battery Operation Time: 120H (12pcs LED at Brightest Mode)
(Fully Charge 8H ; 500 circles)
Power On by Charger directly after battery finishing up its life
With Stepless Dimming Touch Switch
With VDE Charger
With USB Slot
Finish: Satin Nickel/Chrome



Satin Nickel Chrome

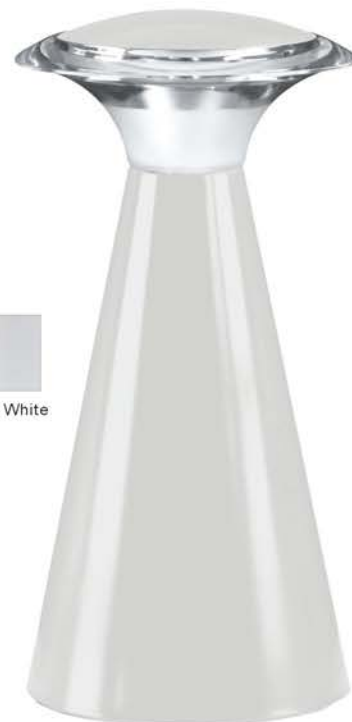

ETLED-18BPTA

Material: ABS Top & Body + PMMA Diffuser
Lamp: 1.44W(12pcs x 0.12W SMD2835 LED) - 3000K+6000K
With 1pc Built-in 3.7V 1200mAh 18650 Lithium Rechargeable battery
Battery Operation Time: 30H(3000K) / 30H(6000K) / 3H(3000K+6000K)
(Fully Charge 6H ; 500 circles)
Power On by USB directly after battery finishing up its life
With 4 Way Touch Switch: 3000K - 6000K - 3000K+6000K - Off
(Stepless Dimming for Each Way by Pressing The Switch Long)
With USB Cable
Color: Black/White/Silver/Pink/Blue/Orange/Green/Green Blue/Pearl White



ETLED-18BPT1

Material: ABS Top & Body + PMMA Diffuser
Lamp: 12 x 0.06W Φ 5 LED Modules
Luminous flux: 60Lm(6000K)
Battery Operating Time: 36H (3 x AA Excl.)
With Touch On/Off Switch
With DC Hole
Color: Black/White/Silver/Pink/Blue/Orange/Green/Green Blue

LED Mushroom Lamp

Patented

-Mushroom Series

- Material: Iron Top & Body + PMMA Diffuser
- Lamp: 0.72W (12 x 0.06W Φ 5 LED)
- Luminous flux: 60Lm(6000K)
- Finish: Satin Nickel/Chrome
- Battery: 3 x AA (Excl.)
- Operating Time: 36H (Alkaline Batteries)
- With Touch On/Off Switch

Option 1



USB Cable

Option 2



AC-USB Adaptor
I/P 100-240V AC 50/60Hz
O/P 5V DC 500mA



reddot design award
winner 2008



GOOD DESIGN PRODUCT



Battery: 3 x AA(Excl.)

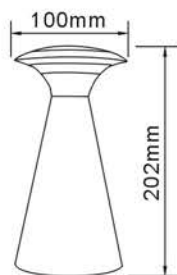

● ETLED-18BT



Chrome



Satin Nickel



LED Mushroom Lamp

-Mushroom Series

- Material: ABS Top & Body + PMMA Diffuser
- Lamp: 0.72W (12 x 0.06W Φ 5 LED)
- Luminous flux: 60Lm(6000K)
- Finish: Black/White/Silver/Pink/Blue/Orange/Green/Green Blue
- Battery: 3 x AA (Excl.)
- Operating Time: 36H (Alkaline Batteries)
- With Touch On/Off Switch

Patented

Option 1



USB Cable

Option 2



AC-USB Adaptor
I/P 100-240V AC 50/60Hz
O/P 5V DC 500mA

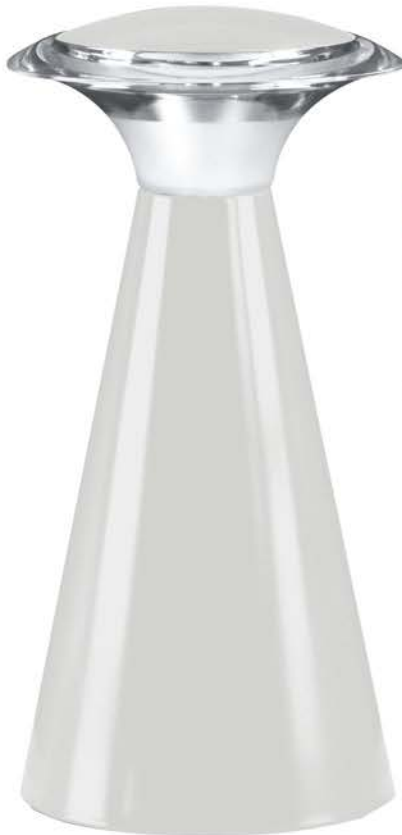

reddot design award
winner 2008



GOOD DESIGN PRODUCT

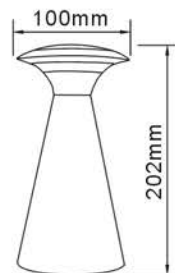

Battery: 3 x AA(Excl.)

● ETLED-18BPT



Green



Green Blue



Black



White



Silver



Pink



Blue



Orange



LED Mushroom Lamp-Ledy

Patented

-Mushroom Series

- Material: Iron Top & Body + PMMA Diffuser
- Lamp: 1.38W (23 x 0.06W Φ 5 LED)
- Luminous flux: 115Lm(6000K)
- Finish: Satin Nickel/Chrome/Gun Metal
- 4 Sections Touch Switch: Low-Medium-High-Off
- Operating Time: 18-86H (Alkaline Batteries)

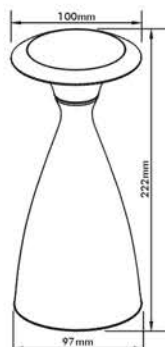

● ETLED - 18F



Battery: 3 x AA(Excl.)



USB Cable



AC-USB Adaptor
I/P 100-240V AC 50/60Hz
O/P 5V DC 500mA



Satin Nickel



Chrome



Gun Metal



LED Portable Lamp

Patented

- Material: Iron Top & Body + PMMA Diffuser
- Lamp: 0.54W (9 x 0.06W Φ 5 LED)
- Luminous flux: 48Lm(6000K)
- Finish: Satin Nickel/Chrome
- Battery: 3 x AA (Excl.)
- Operating Time: 36H (Alkaline Batteries)

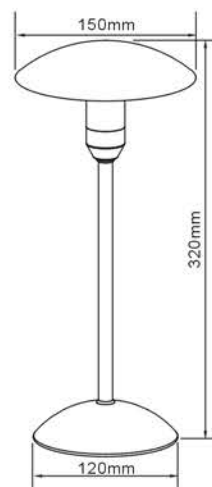

● ETLED-10A

Battery Operation



Battery: 3 x AA(Excl.)



Battery Operated Light

- Material: ABS Head + Iron Gooseneck
- Lamp: 0.5W Φ 8 LED / 0.05W LED
- Luminous flux: 28Lm(6000K)
- With 3pcs Mercury Battery(Button Battery)
- Operating Time: >24H
- ON/OFF Switch On Ball
- Finish: Black/Purple/Green/Pink/Blue



3pcs Mercury Battery
(Button Battery)

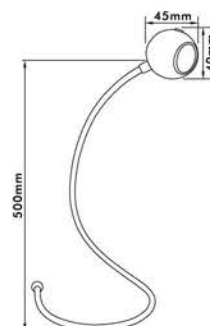

● ● BO-LED70

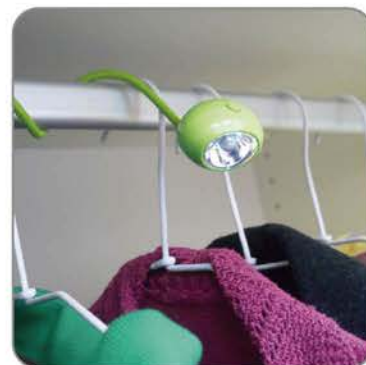
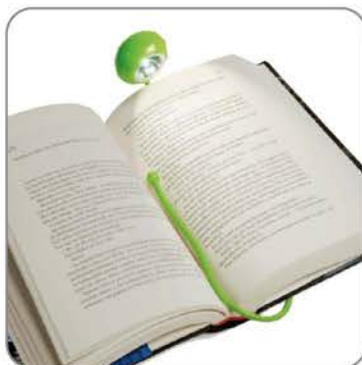

USB LED Portable Reading Lamp-Yoyo

- Material: PC Body + Iron Gooseneck
- Lamp: 0.5W SMD5630 LED Modules
- Luminous flux: 30Lm(5000K)
- Finish: White/Black/Pink/Blue/Orange/Green
- With Black USB Plug + Black Flexible Tube
- Illuminance(20cm): >300Lux

Patented

0.5W LED
Super Bright
300 Lux(20cm)



Blue



Pink



Green



White



Black



Orange

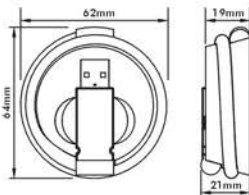

● BLED-006

Method of use:

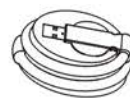

A. Roll up



B. Stretch



C. Fix

(Recommended position)



9-in-1 Battery Operated LED Light

Multi-function use, as mood light, camping light, torch, night light, fishing light, corridor light, step light

- Material: ABS Base & Top + PC Clear & Opal Diffuser
- Lamp: 1W (2 x 0.5W SMD5730 LED)
- Lumen: 60LM (6000K)
- Battery Working Time: 20H (3 x AA Excl.)
- With 2 Hanging loops & Magnets
- Color: White / Pink / Green

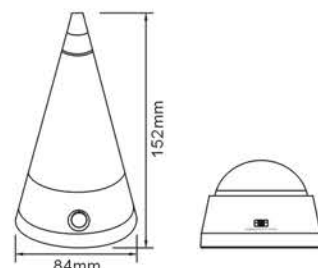

● **BO-LED023**



Press On/Off Version



● **BO-LED023S**



PIR + CDS Sensor Version
CDS: Working when < 10Lux
PIR: 2.5M, 20S, Horizontal 100°, Vertical 50°



Magnet-use 1

Table Lamp
(Light on effect)

Magnet-use 2

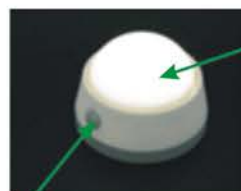

Push On Off

Press On Off



2pcs powerful magnets



Lantern-1 Lantern-2 Lantern-3



Torch



Battery Operated LED Mood Light & Camping Light

- Material: ABS
- Color: Black / White / Orange / Green / Pink / Blue

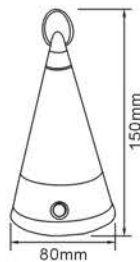

● BO-LED022A

Lamp: 0.24W (12 x 0.02W LED)
Lumen: 20LM (5000K~7500K)
Battery Working Time: 25H (3 x AA Excl.)
4-Way Press Switch: 3 LED On - 12 LED On - Flash - Off

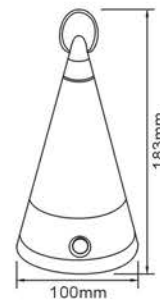

● BO-LED022

Lamp: 0.38W (19 x 0.02W LED)
Lumen: 40LM (5000K~7500K)
Battery Working Time: 20H (4 x AA Excl.)
3-Way Press Switch: 7 LED On - 19 LED On - Off



LED Battery Operated Light-Tumbler

- Material: ABS+PP housing
- Lamp: 0.5W (1 x 0.5W LED)
- Battery: 3 x LR44 button batteries Incl.
- Battery Working Time: 2-3H at Brightest illumination / 2-3 days to light off
- Color Temperature: 2700K~6500K
- 11000-13000MCD (6500K)
- Rotary On/Off Switch
- Color: Green / Black / Pink / Blue / Orange

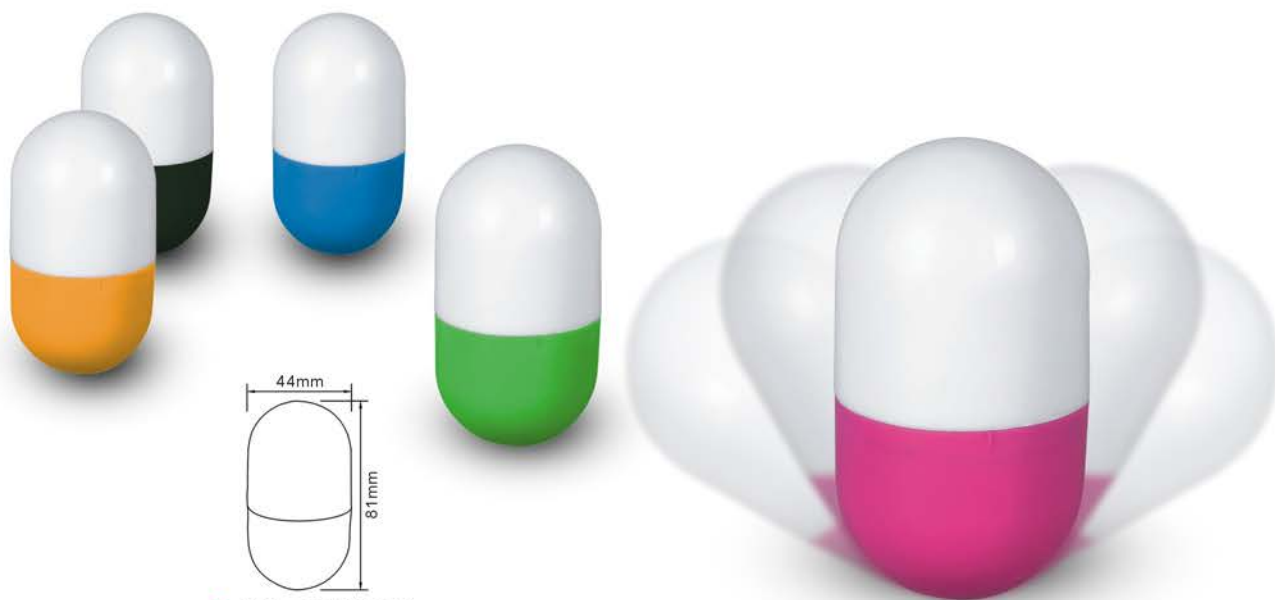

● BO-LED017



LED Battery Operated Light-Tumbler

- Material: ABS
- Lamp: 1W (1x 1WLED)
- Battery Working Time: 20H (4 x AA Excl.)
- Color Temperature: 2700K~7500K
- 60LM (5000~7500K)
- 4-Way Press Switch: High-Low-Flash-Off
- Color: Green / Black / Pink / Blue / Orange

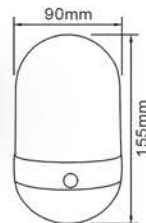

● BO-LED019

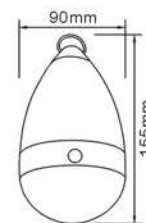

● BO-LED019A



Interior Plant Growth Light

Home Resource 2017 Collection

LED *GROW* Light for Plant-**Aladdin**

- Material: Iron Body + ABS Base + Glass Bucket
- Lamp: 8 x 0.125W SMD2835 Red LED and 4 x 0.125W SMD2835 Blue LED and 8 x 0.125W SMD2835 White LED 4000K
- Power Consumption: 2.5W
- 2 Switches on base
- Switch for PLANT: Red Light and Blue Light
(if the switch is not closed, will automatically shut down after 4H)
- Switch for LAMP: White Light
- With 1.2m USB Cable
- Finish: White / Blue / Orange / Green / Green Blue
- IP20

Patented

Option 1



With 1.2m USB Cable

Option 2



AC-USB Adaptor
I/P 100-240V AC 50/60Hz
O/P 5V DC 500mA

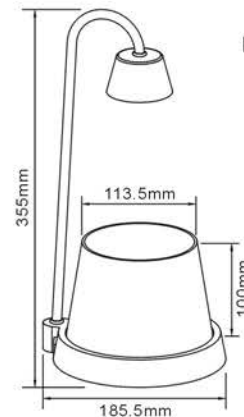

PNLED-136



LED *GROW* Light for Plant-Swan

- Material: ABS Body + Glass Bucket
- Lamp: 8 x 0.125W SMD2835 Red LED and 4 x 0.125W SMD2835 Blue LED and 8 x 0.125W SMD2835 White LED 4000K
- Power Consumption: 2.5W
- 2 Switches on base
- Switch for PLANT: Red Light and Blue Light (if the switch is not closed, will automatically shut down after 4H)
- Switch for LAMP: White Light
- With 1.2m USB Cable
- Finish: White / Blue / Orange / Green / Green Blue
- IP20

Patented

Option 1



With 1.2m USB Cable

Option 2



AC-USB Adaptor
I/P 100-240V AC 50/60Hz
O/P 5V DC 500mA

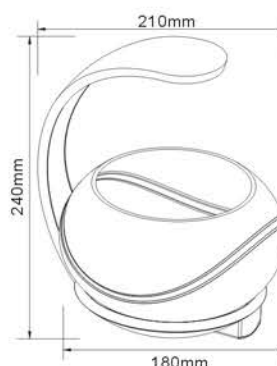

PNLED-137



LED *GROW* Light for Plant-Halo

- Material: ABS Body + Glass Bucket
- Lamp: 8 x 0.125W SMD2835 Red LED and 4 x 0.125W SMD2835 Blue LED and 8 x 0.125W SMD2835 White LED 4000K
- Power Consumption: 2.5W
- 2 Switches on base
- Switch for PLANT: Red Light and Blue Light
(if the switch is not closed, will automatically shut down after 4H)
- Switch for LAMP: White Light
- With 1.2m USB Cable
- Finish: White / Blue / Orange / Green / Green Blue
- IP20

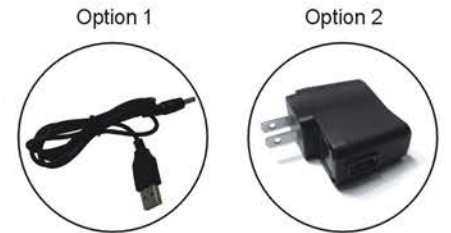

With 1.2m USB Cable

AC-USB Adaptor
I/P 100-240V AC 50/60Hz
O/P 5V DC 500mA

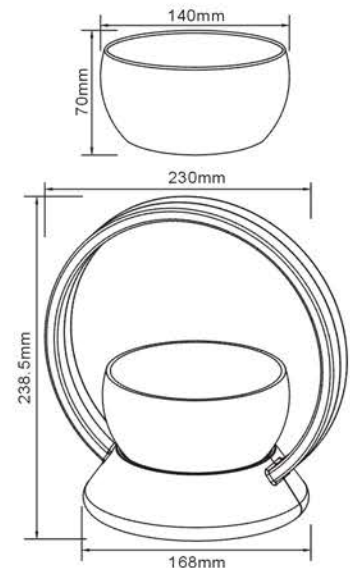

● PNLED-140



**Interior Wall /
Reading Light & Table /
Reading Light**

Home Resource 2017 Collection

7W LED Table Lamp-Elite III QC (Quick Charge) 2.0 Version

Patented

- Material: ABS Body
- Lamp: 6W (12 x 0.5W SMD5630 LED Modules)
- Luminance: > 1200 Lux (40cm) / Luminous flux: 440LM (4000K)
- Power consumption: 9W
- With 4 Section Touch Switch on Base: White-Blue-White+Blue-Off
- White (Main light) ; Blue (Night Light)
- With Night Light: 6 x 0.06W Φ 5 Blue LEDs
- With USB Slot (Output: 5V 2A / 9V 1.7A / 12V 1.5A)
- Finish: Painting White / Painting Black / Rubber White / Rubber Black

12 x 0.5W LED
Super Bright
1200 Lux



Adaptor

Being folded when not in working

Night Light

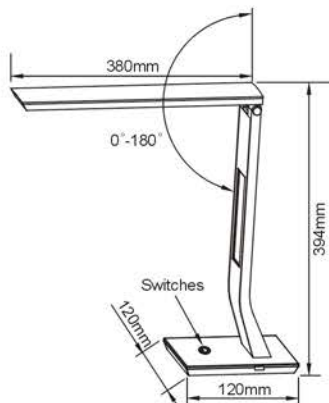

● TLED-21AU



Qi Wireless Charging LED Table Lamp - Elite

Patented

- Material: ABS Body
- Lamp: 6W (12 x 0.5W SMD5630 LED Modules)
- Luminous Flux: 440LM (4000K)
- Lux: 1200Lux(H.40cm)
- With USB Slot (Output: 5V 500mA)
- Power Consumption: 17.5W (Including wireless charging modules)
- Finish: White/Black
- Being folded when not in working

12 x 0.5W LED
Super Bright
1200 Lux

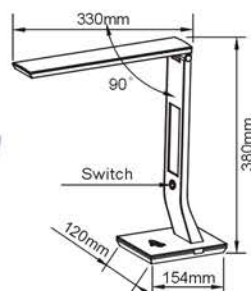

● TLED-21BU



Adapter



Being folded when not in working



Decorative Board, can put your own logo / design here



Wirelessly Charge iPhone 5/5S/5C or iPhone 6 or iPhone 6 Plus



Qi Wireless Charging LED Table Lamp - Concord

Patented

- Material: ABS Head & Base + Iron Tube
- Lamp: 6 x 0.5W SMD5630 LED Modules
- Power Consumption: 4.5W
- Luminance: > 900 Lux (30cm) / Luminous flux: 200LM (4000K)
- With Stepless Dimming Switch on Base
- With USB Slot (Output: 5V 1A)
- Finish: Black/White/Green



Adapter



Wirelessly Charge iPhone 5/5S/5C
or iPhone 6 or iPhone 6 Plus

LED Table/Clip/Floor Lamp-Swan

- Material: Aluminum + Steel + PC
- Color Temperature: 3000K ~ 6500K
- With 1.6M Cable + VDE Plug
- Finish: Black / White



CE EMC

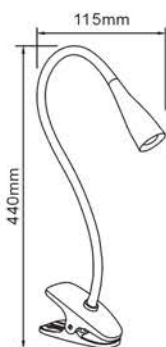

● **TCLED-954B**

AC type
Voltage: 220V ~ 240V
Lamp: 4.5W (6 x SMD2835 LED)
Lumen: 370LM (4000K)
Line On/Off Switch

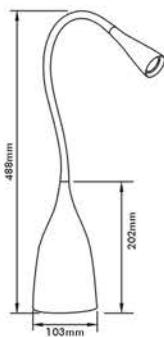

● **TLED-954B**

Voltage: 100V ~ 240V
Lamp: 4.5W (12 x SMD2835 LED)
Lumen: 450LM (4000K)
With VDE Adapter + 1.6M Cable

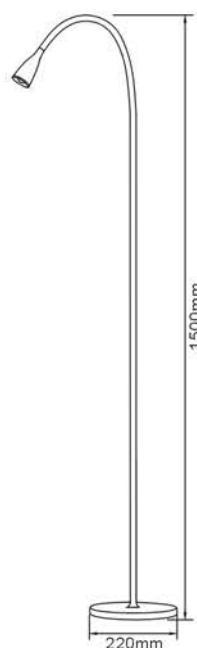

● **FLKLED-954B**

AC type
Voltage: 220V ~ 240V
Lamp: 4.5W (6 x SMD2835 LED)
Lumen: 370LM (4000K)
Foot On/Off Switch

LED Interior Wall Light-Swan

- Material: Aluminum + Steel + PC
- Color Temperature: 3000K ~ 6500K
- With USB Slot (5V/1A)
- Finish: Black/White

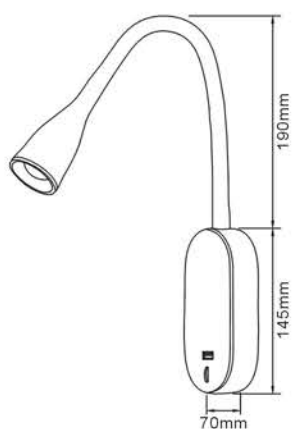

● WLED-954BU

AC Type
Voltage: 220V ~ 240V
Lamp: 4.5W (6 x SMD2835 LED)
Lumen: 450LM (4000K)
Press On/Off Switch on Base

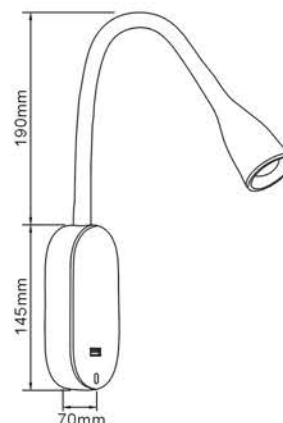

● WLED-954BUT

Voltage: 100V ~ 240V
Lamp: 4.5W (12 x SMD2835 LED)
Lumen: 370LM (4000K)
With Built-in Driver on base
4-Way Touch Switch on Base: 100%-50%-10%-Off
(Brightness of Touch Switch indicator is inversely to that of Spot Light)

LED Table Lamp-Swan

- Material: Aluminum + Steel + PC
- Voltage: 100V ~ 240V
- Lamp: 3W (6 x SMD2835 LED)
- Lumen: 280LM (4000K)
- With VDE Adapter + 1.6M Cable
- Touch Dimmable Switch on Base
- Finish: White/Black/Red



CE EMC

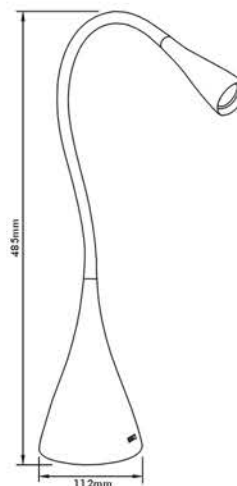

● TLED-954



LED Table Lamp-Penguin Series

- Material; ABS Body + PC Diffuser
- AC Type
- Voltage: 220V ~ 240V
- Lumen: 300LM (4000K)
- Color Temperature; 3000K ~ 6500K
- With 1.6M Cable + VDE Plug
- Line On/Off Switch



● TLED-143

Lamp: 4.5W (6 x SMD2835 LED)
Color: Black/Silver/Champagne
Shade + Black Base or
Silver Shade + White Base

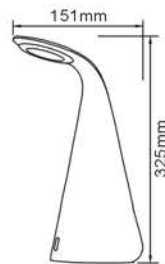

● TLED-144

Lamp: 4.5W (14 x SMD2835 LED)
Color: Black/White/Blue



LED Table/Clip/Floor Lamp-Dona

- Material: ABS + Steel + PC
- AC Type
- Voltage: 220V ~ 240V
- Lamp: 5W (14 x SMD2835 LED)
- Lumen: 500LM (4000K)
- With 1.6M Cable + VDE Plug
- Finish: White/Black/Red



● **TCLED-223**
Line On/Off Switch



● **TLED-223**
Button On/Off Switch on Base



● **WLED-223**
Button On/Off Switch on Base



● **FLKLED-223**
Foot On/Off Switch

LED Table Lamp/LED Clip Lamp

- Material: Material: ABS + Iron
- Lamp: 3W (6 x 0.5W SMD 5630 LED)
- Ra>80
- Finish: Black / Blue / Green / Purple / Red / Silver
- Lumen: 285LM (4000K)
- Super Bright 1830 Lux (H.30cm)
- 1.5M Cable + Adapter
- Line On/Off Switch

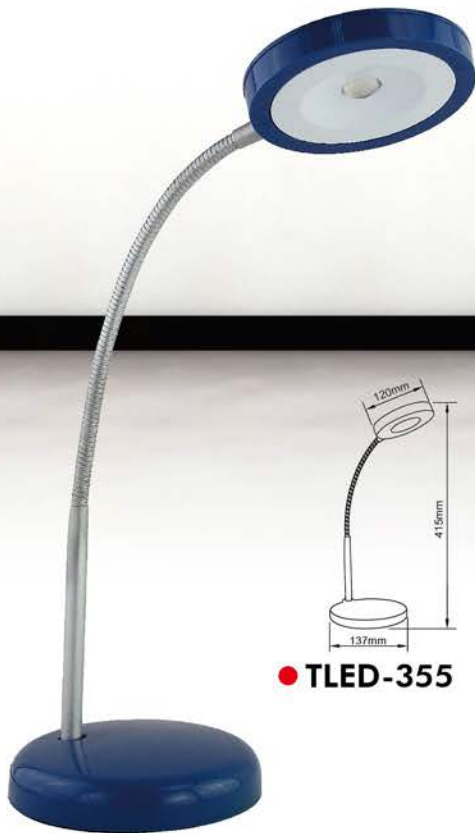

● TLED-355

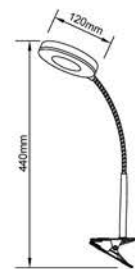

● TCLED-355

LED Table Lamp

Patented

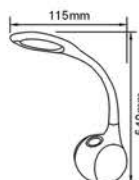

● TLED-110

Materials: ABS + PP + Rubber
Lamp: 6W(34pcs x 0.15W SMD2835 + 2pcs x 0.5W Φ 5 RGB LED)
Lumen: 230LM(5500K)
Color Temperature: 5000K ~ 5500K
Lamp illumination: > 500lux(H.30CM)
Main Light: 4-Section Touch Switch (25%-50%-100%-Off)
Night Light: Gradient Switch
With LED Driver
Color: White



● TLED-325

Material: ABS
Lamp: 5.5W(11PCS x 0.5W SMD5730 LED)
Voltage: AC 100V~240V
Lumen: 230LM(6000K)
Color Temperature: 2700K ~ 6500K
4-Section Touch Switch (25%-50%-100%-Off)
With 1.5M USB Cable
Color: White



● TLED-327

Material: ABS
Lamp: 4W(16PCS x SMD2835 + 3pcs x SMD5050 RGB LED)
Lux: 400Lux (5000K)
Color Temperature: 5000K ~ 5500K
Lumen: 120LM (5000K)
Main Light: 4-Section Touch Switch (25%-50%-100%-Off)
Night Light: Gradient Switch
With 1pc 1000mA Rechargeable Battery(Charging 2H, Working 3H)
With USB Cable
Color: White

LED Table Light

Patented

- Material: ABS + Iron
- Lamp: 3W (6 x 0.5W SMD5630 LED)
- Ra>80
- Finish: White/Black/Yellow/Green/Blue/Pink
- Lumen: 210LM
- Super Bright 880 Lux (H.30cm)
- Built-in LED Driver
- 1.8M Cable + Plug
- On/Off Switch on base

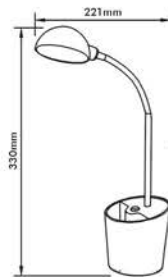

● TLED-111



LED Table Lamp-Magic Cone

Patented

- Material: ABS Body
- Lamp: 1.8W (9 x 0.06W Φ 5 LED)
- Luminous flux: 110Lm(6000K)
- Finish: White
- With Touch On/Off Switch
- Operating Time: 0-4H 1000-700 Lux --High
4-8H 700-400 Lux --Medium
8-18H 400-100 Lux --Low
(Alkaline Batteries)



Battery: 3 x AA(Excl.)

Option 1



USB Cable

Option 2



AC-USB Adaptor
I/P 100-240V AC 50/60Hz
O/P 5V DC 500mA

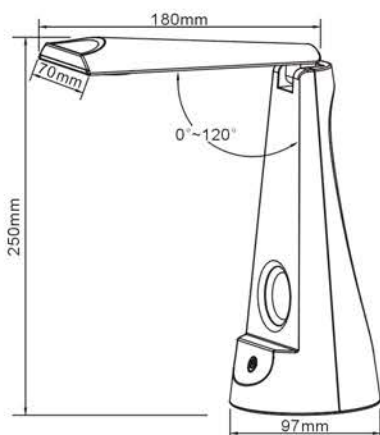

● ETLED-27AT/AT1



LED Reading Light

-Piano Series

- Material: Iron Body
- Lamp: 2W (4 x 0.5W SMD5630 LED)
- Luminous flux: 80Lm(4000K)
- With Toggle Switch On Base
- Finish: Bronze/Satin Nickel

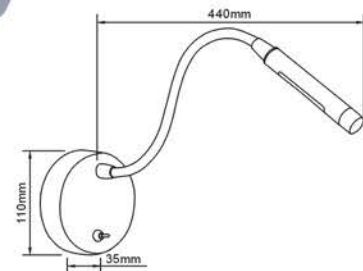

● WLED-152R



LED Reading Light

- Material: Iron Body
- Lamp: 1W LED
- Luminous flux: 85Lm(6000K)
- Finish: Satin Nickel/Chrome

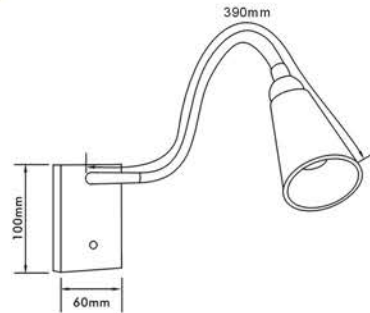

● **WLED-14**
With Push Switch on The Base

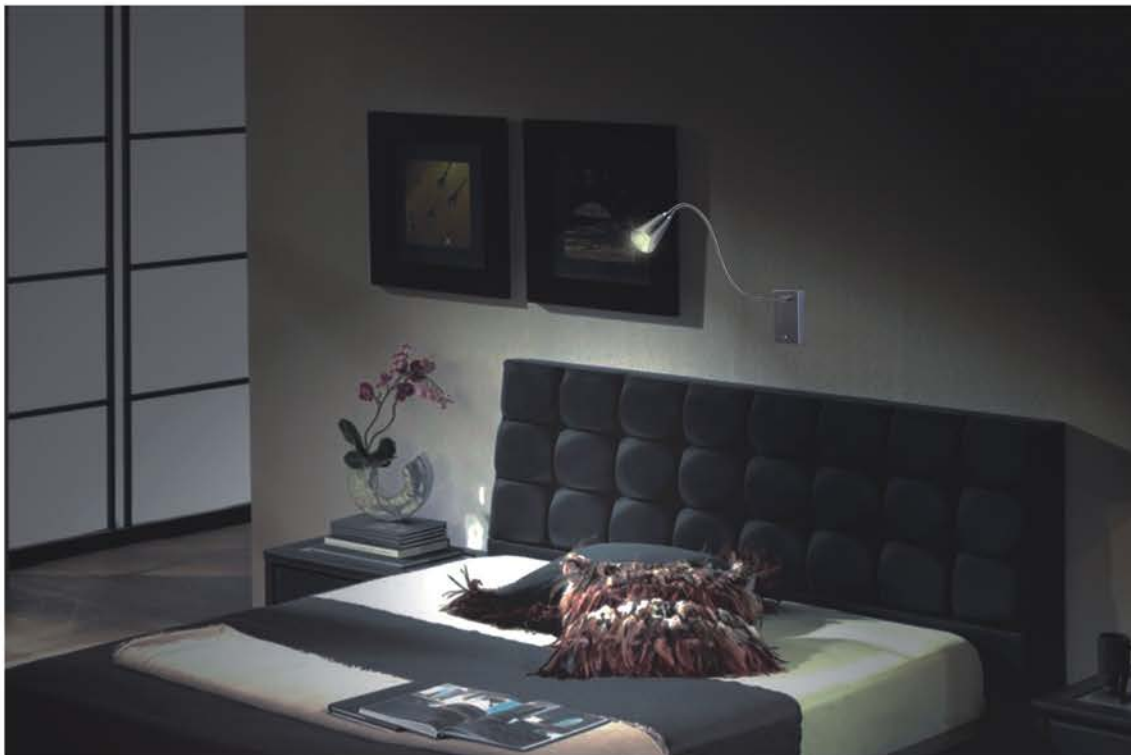

2-in-1 LED Wall/Reading Light

- Material: Stainless Steel Mounting Plate + Zinc Alloy Spot Head + Steel Parts + Fabric Lamphsade
- Lamp: Built-in 1W LED + E27 10W LED Bulb (Excl.)
- Luminous Flux: 80LM (6000K Spot Light)
- Finish: Chrome/Metallic Dark Copper/Satin Nickel/White/Black
- Shade Color: White/Black/Cream Cloud/Burgundy

Patented

1W LED
Super Bright
1100 Lux

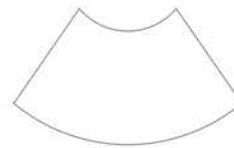

White



Black



Cream Cloud



Burgundy

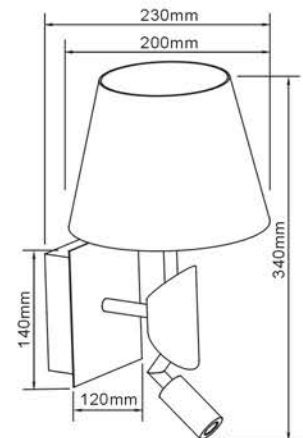

WLED-214



2-in-1 LED Wall/Reading Light

- Material: Stainless Steel Mounting Plate + Zinc Alloy Spot Head + Steel Parts + Fabric Lamphsade
- Lamp: Built-in 1W LED + E27 10W LED Bulb (Excl.)
- Luminous Flux: 80LM (6000K Spot Light)
- Finish: Chrome/Metallic Dark Copper/Satin Nickel/White/Black
- Shade Color: White/Black/Cream Cloud/Burgundy

Patented

1W LED
Super Bright
1100 Lux

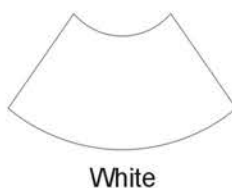

White



Black



Cream Cloud



Burgundy

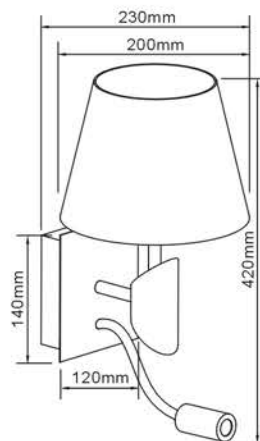

WLED-214A



2-in-1 LED Wall/Reading Light

- Material: Stainless Steel Mounting Plate + Zinc Alloy Spot Head + Steel Parts + Fabric Lamphsade
- Lamp: Built-in 1W LED + E27 10W LED Bulb (Excl.)
- Luminous Flux: 80LM (6000K Spot Light)
- Finish: Chrome/Metallic Dark Copper/Satin Nickel/White/Black
- Shade Color: White/Black/Cream Cloud/Burgundy

Patented

1W LED
Super Bright
1100 Lux

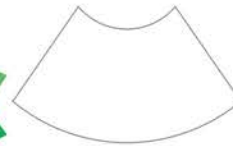

White



Black



Cream Cloud



Burgundy

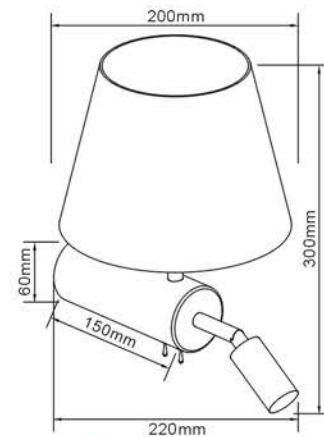

WLED-215



2-in-1 LED Wall/Reading Light

- Material: Stainless Steel Mounting Plate + Zinc Alloy Spot Head + Steel Parts + Fabric Lamphsade
- Lamp: Built-in 1W LED + E27 10W LED Bulb (Excl.)
- Luminous Flux: 80LM (6000K Spot Light)
- Finish: Chrome/Metallic Dark Copper/Satin Nickel/White/Black
- Shade Color: White/Black/Cream

Patented

1W LED
Super Bright
1100 Lux

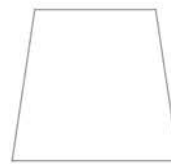

White



Black

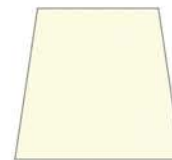

Cream

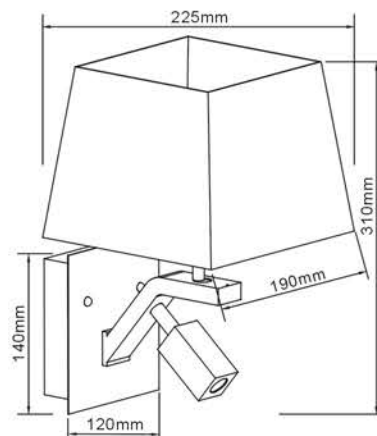

WLED-216



2-in-1 LED Wall/Reading Light

- Material: Stainless Steel Mounting Plate + Zinc Alloy Spot Head + Steel Parts + Fabric Lamphshade
- Lamp: Built-in 1W LED + E27 10W LED Bulb (Excl.)
- Luminous Flux: 80LM (6000K Spot Light)
- Finish: Chrome/Metallic Dark Copper/Satin Nickel/White/Black
- Shade Color: White/Black/Cream Cloud/Burgundy

Patented

1W LED
Super Bright
1100 Lux

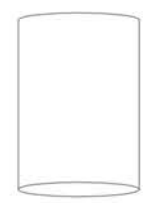

White



Black



Cream Cloud



Burgundy

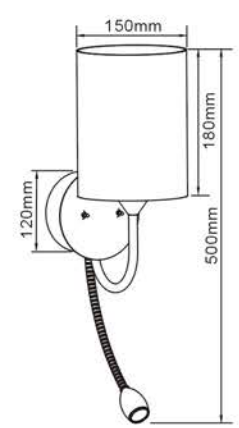

WLED-217



2-in-1 LED Wall/Reading Light

- Material: Stainless Steel Mounting Plate + Zinc Alloy Spot Head + Steel Parts + Fabric Lamphsade
- Lamp: Built-in 1W LED + E27 10W LED Bulb (Excl.)
- Luminous Flux: 80LM (6000K Spot Light)
- Finish: Chrome/Metallic Dark Copper/Satin Nickel/White/Black
- Shade Color: White/Black/Cream Cloud/Burgundy

Patented

1W LED
Super Bright
1100 Lux

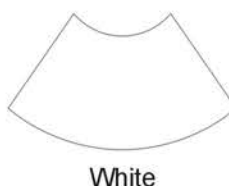

White



Black



Cream Cloud



Burgundy

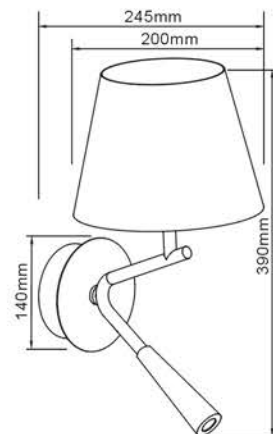

WLED-218



2-in-1 LED Wall/Reading Light

- Material: Stainless Steel Mounting Plate + Zinc Alloy Spot Head + Steel Parts + Fabric Lamphsade
- Lamp: Built-in 1W LED + E27 10W LED Bulb (Excl.)
- Luminous Flux: 80LM (6000K Spot Light)
- Finish: Chrome/Metallic Dark Copper/Satin Nickel/White/Black
- Shade Color: White/Black/White Flower/Black with Golden Flower/Beige Cloud/Burgundy

Patented



1W LED
Super Bright
1100 Lux



White



Black



Black (Golden Flower)



White Flower



Beige Cloud



Burgundy

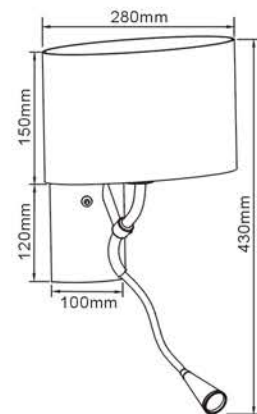

WLED-219



2-in-1 LED Wall/Reading Light

- Material: Stainless Steel Mounting Plate + Zinc Alloy Spot Head + Steel Parts + Fabric Lamphsade
- Lamp: Built-in 1W LED + E27 10W LED Bulb (Excl.)
- Luminous Flux: 80LM (6000K Spot Light)
- Finish: Chrome/Metallic Dark Copper/Satin Nickel/White/Black
- Shade Color: White/Black/Linen

Patented

1W LED
Super Bright
1100 Lux



White



Black



Linen

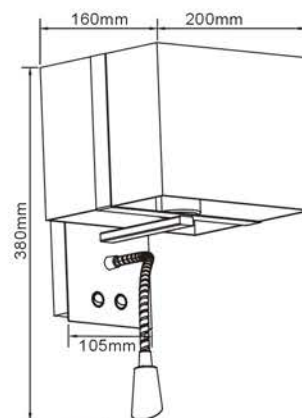

WLED-220



2-in-1 LED Wall/Reading Light

- Material: Steel Body + Fabric Shade
- Lamp: Built-in 3W (1x3W) LED + E27 6W LED Bulb (Excl.)
- Finish: White

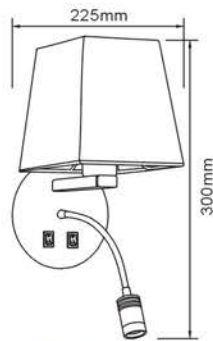

● WLK350

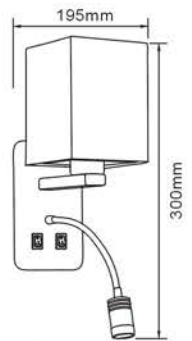

● WLK351

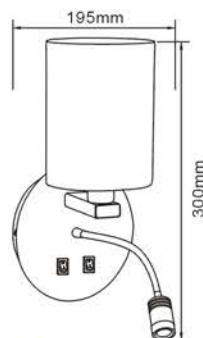

● WLK352

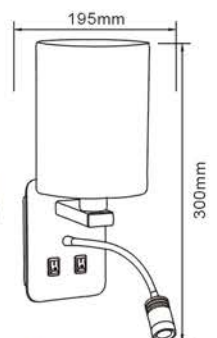

● WLK352A

Interior Wall Lamp with USB Ports

- Material: Steel Body + Fabric Shade
- Finish: White

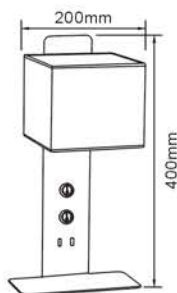

● **WLK150U**

Bulb Adaptable: 2 x E14 6W LED Bulb
With 2 USB Ports

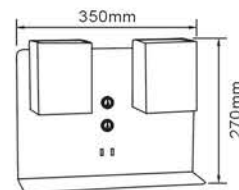

● **WLK150U-2**

Bulb Adaptable: 2 x E14 6W LED Bulb
With 2 USB Ports

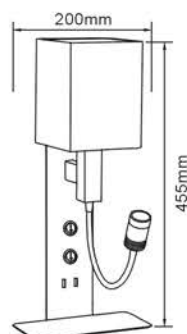

● **WLK153U**

Lamp: Built-in 3W (1x3W) LED
+ E27 6W LED Bulb (Excl.)
With 2 USB Ports

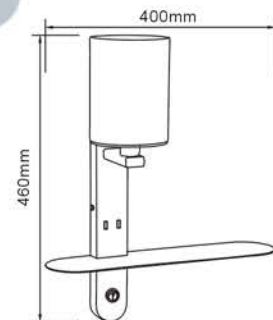

● **WLK151U**

Bulb Adaptable: E14 6W LED Bulb
With 2 USB Ports

2-in-1 Wall/Reading Light

- Material: Iron Base + Aluminium/Zinc Alloy Spot Head + Fabric Lampshade
- Lamp: 1W built-in LED + E27 10W LED bulb A type
- Luminous flux: 80Lm(6000K)
- Finish: Chrome/Metallic Dark Copper/Satin Nickel

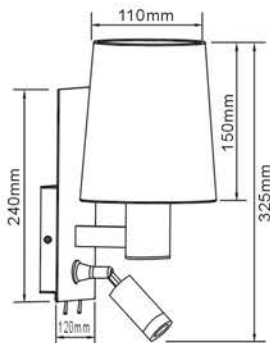

● WLED-203B White

Lampshades of WLED-203B/204B Series:



B: White



B2: Black



B3: Cream Cloud



B4: Burgundy

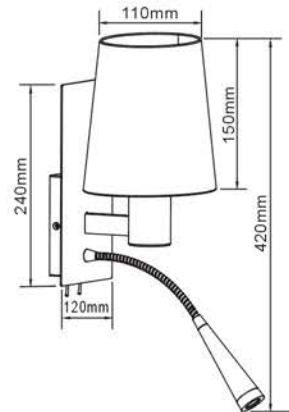

● WLED-204B2 Black

2-in-1 Wall/Reading Light & Table/Reading Light

- Material: Iron Base + Aluminium/Zinc Alloy Spot Head
Fabric Lampshade
- Lamp: 1W built-in LED + E27 10W LED bulb A type 
- Luminous flux: 80Lm(6000K)
- Finish: Chrome/Metallic Dark Copper/Satin Nickel



● **DFLED-304D3** Beige Cloud

Lampshades of WLED-303D/304D & DF-304D Series:



D1: White Flower



D2: Black (Golden Flower)



D3: Beige Cloud



D4: Burgundy

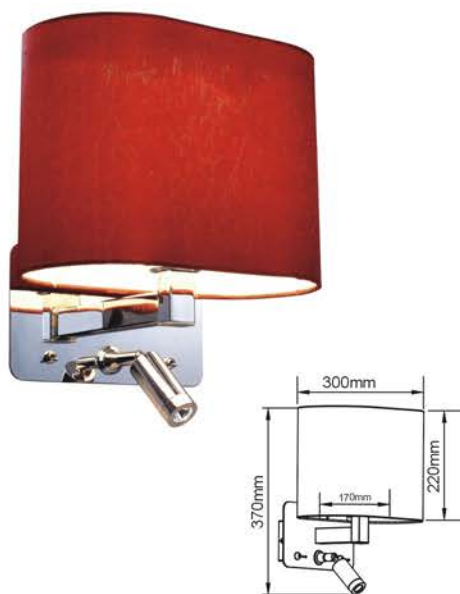

● **WLED-303D4** Burgundy



● **WLED-304D1** White Flower

Table Lamp

- Material: Iron
- Bulb Adaptable: GU10 6W LED Bulb 
- With 1.6M Power Cable + Line Switch + VDE Plug
- Finish: White/Chrome/Antique Brass/Gunmetal/Satin Nickel



● ● DA-4A



White



Gunmetal



Chrome



Satin Nickel



Antique Brass



Desk & Clip-on Lamps

- Material: Pressed Iron
- On/off Switch on Line
- Color Available: Titan, White & Metallic Blue/Red

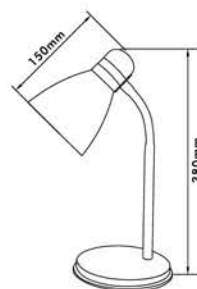

DF-2
E14 G45 5W LED Bulb



DA-8C
E27 10W LED Bulb



DC-2
E14 G45 5W LED Bulb



DF-6
E27 G45 5W LED Bulb



DC-9
E27 G45 5W LED Bulb

Interior Spot Light

Home Resource 2017 Collection

LED Spot Light-Swan

- Material: Aluminum + Steel + PC
- AC Type
- Voltage: 220V ~ 240V
- Lamp: 4.5W (6 x SMD2835 LED) per head
- Color Temperature: 3000K ~ 6500K
- Finish: Black / White



CE EMC



● **TKLED-954B-2**
Lamp: 9W (2 x 4.5W LED)
Lumen: 2 x 370LM (4000K)



● **TKLED-954B-3**
Lamp: 13.5W (3 x 4.5W LED)
Lumen: 3 x 370LM (4000K)

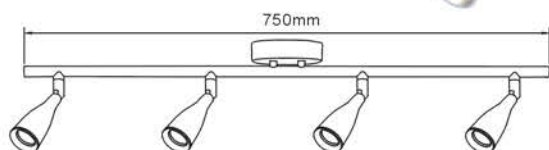

● **TKLED-954B-4**
Lamp: 18W (4 x 4.5W LED)
Lumen: 4 x 370LM (4000K)

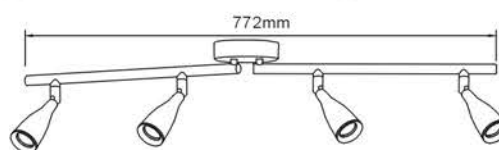

● **TZKLED-954B-4**
Lamp: 18W (4 x 4.5W LED)
Lumen: 4 x 370LM (4000K)



● **CKLED-954B**
Lamp: 4.5W LED
Lumen: 370LM (4000K)

LED Sensor Spot Light

- Material: ABS Body + PC Diffuser
- Color Temperature: 2700K ~ 6500K
- PIR Sensor: 5M, 18 Secs, 100°
- Color: White/Black/Copper/Brass/Silver

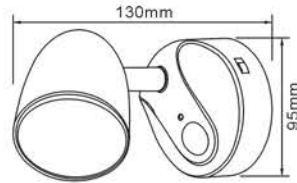

● CKLED866BOS

Battery Operated Version

Lamp: 1.2W (20pcs x SMD3014 LED)
Battery: 3 x AAA (Excl.)
Batter Operated Time: 20H

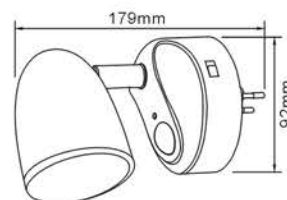

● CKLED866P

Mains Version

Lamp: 1.5W (20pcs x SMD3014 LED)
Voltage: AC 85V ~ 265V
With VDE or BS plug

LED Spot Light

- Material: Aluminum Canopy + ABS Body + PC Diffuser
- Lamp: 6W (60pcs x 0.1W SMD3014 LED)
- Voltage: AC 85V ~ 265V
- Color Temperature: 2700K ~ 6500K
- Luminous Flux: 300LM (3000K)
- Color: White/Black/Copper/Brass/Silver

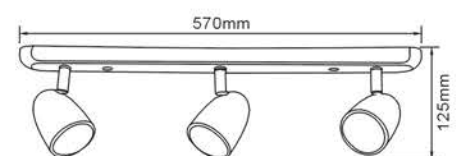

● **TKLED868-3**

AC (driverless) LED Spot Light

- Material: Iron base + Plastic shade
- AC type Built-in 5W (17pcs 0.3W SMD2835) LED for each head
- Voltage: 230V
- Finish: Chrome / Satin Nickel

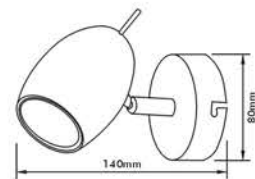

● **CKLED530**

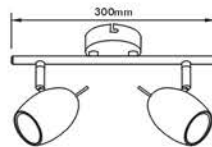

● **TKLED530-2**

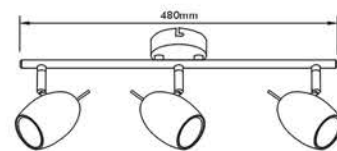

● **TKLED530-3**

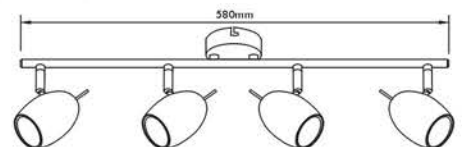

● **TKLED530-4**

AC type Built-in LED Spot / Wall / Ceiling Light

- Material: Iron Base + Plastic Shade
- AC type Built-in 4W (26pcs x 0.16W SMD2835) LED for each head
- Voltage: 230V
- Lumen: 400LM per Head (4000K)
- Finish: Black / White / Silver Painting or Chrome Plated

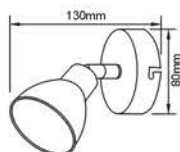

● CKLED327A

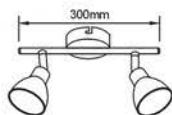

● TKLED327A-2

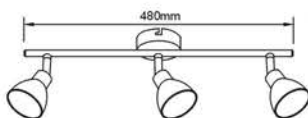

● TKLED327A-3

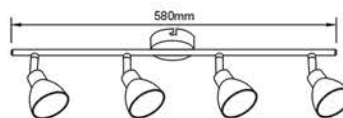

● TKLED327A-4



AC (driverless) LED Spot Light

- Material: Iron + Glass
- AC type Built-in 5W (17pcs 0.3W SMD2835) LED for each head
- Voltage: 230V
- Finish: Iron in Chrome / Satin Nickel + Glass in White

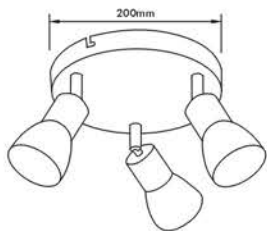

● CKLED94A-3

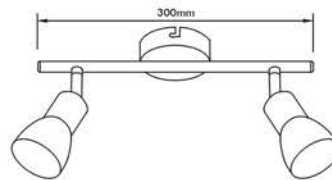

● TKLED94A-2

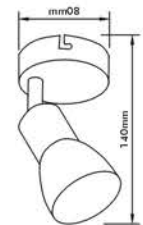

● CKLED94A

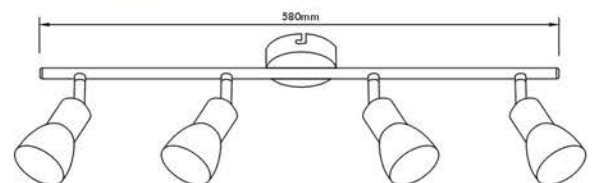

● TKLED94A-4

Wall & Ceiling Spotlight

- Material: Aluminum + Iron
- Bulb Adaptable: GU10 6W LED Bulb 
- Finish: Aluminum Brushed + Chrome

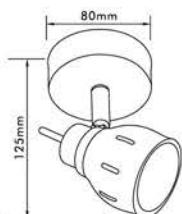

● CK193-1

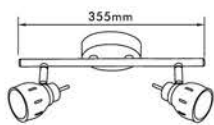
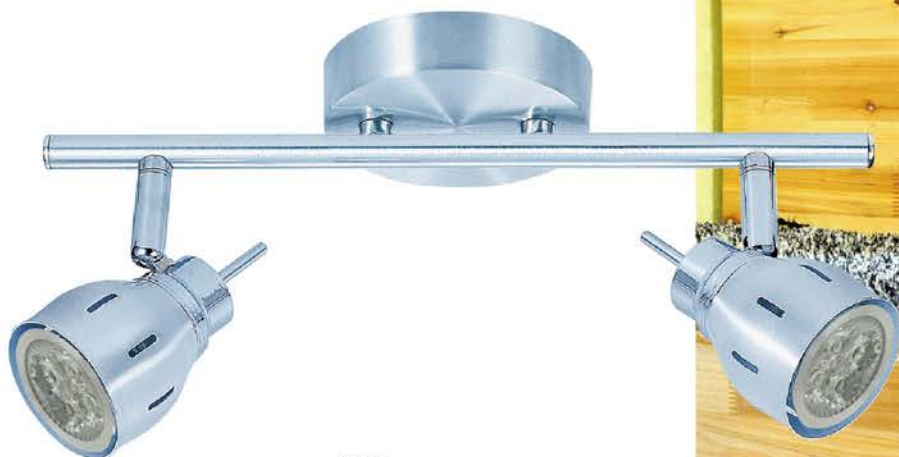

● TK193-2

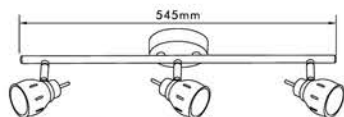

● TK193-3

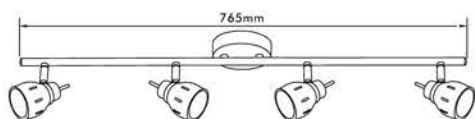

● TK193-4



Wall & Ceiling Spotlight-Sicily

- Material: Pressed Iron
- Bulb Adaptable: GU10 6W LED Bulb 
- Finish: Chrome+Titan/Chrome+Satin Nickel/
Polished Brass+Satin Brass



● CK19-1

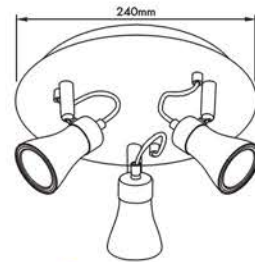

● CK19-3

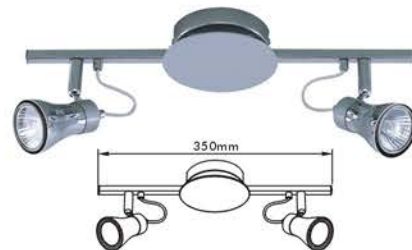

● TK19-2

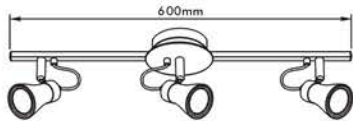

● TK19-3

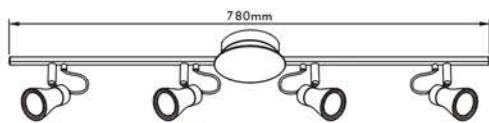

● TK19-4



Wall & Ceiling Spotlight

- Material: Iron
- Bulb Adaptable: GU10 6W LED Bulb 
- Finish: Chrome/Satin Nickel/Satin Brass/P. Brass/
White/Black

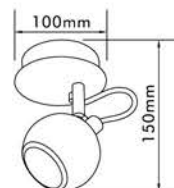

● CK71A-1



● CK71A-2

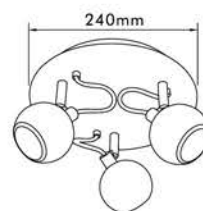

● CK71A-3

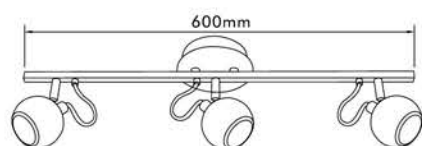

● TK71A-3

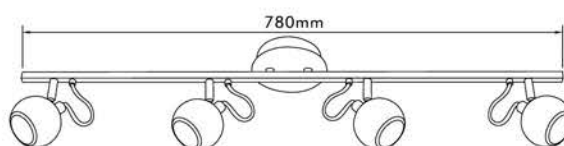

● TK71A-4

LED Wall & Ceiling Spotlight

- Material: Metal + Wood
- Lamp: 4W (17 x SMD2835 LED) per Light
- Lumen: 320LM (2700K) per Light
- Color Temperature: 2700K ~ 6500K
- Finish: Satin Nickel + Wood

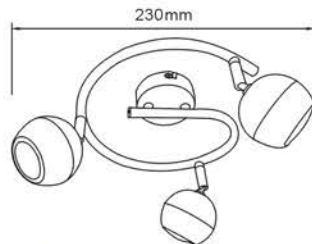

● CTKLED118-3



● TKLED118-2

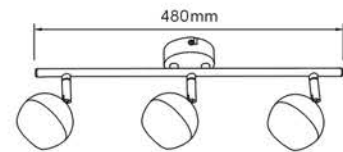

● TKLED118-3

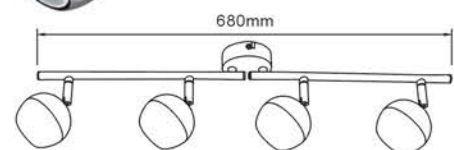

● TKLED118-4

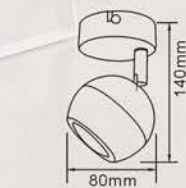

● CKLED118

Wall & Ceiling Spotlight-Poco

- Material: Zinc Alloy + Iron
- Bulb Adaptable: GU10 6W LED Bulb
- Finish: Satin Nickel/Satin Brass/Chrome/Polished Brass

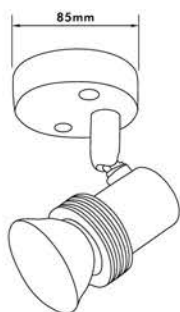

● CK12-1

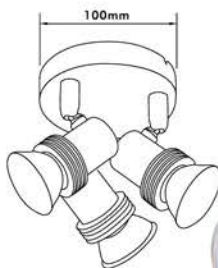

● CK12-3

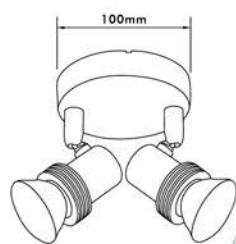

● CK12-2

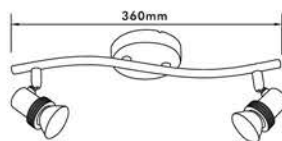

● STK12-2

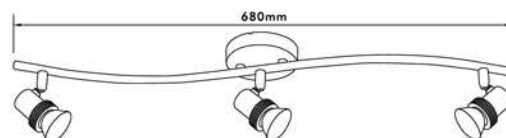

● STK12-3



Wall & Ceiling Spotlight-Facil

- Material: Zinc Alloy + Iron
- Bulb Adaptable: GU10 6W LED Bulb
- Finish: Chrome/Satin Nickel/Satin Brass



● CK17-1

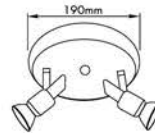

● CK17-2

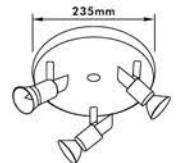

● CK17-3

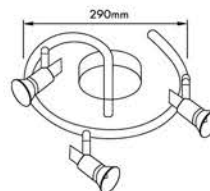

● CTK17-3

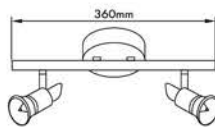

● TK17-2

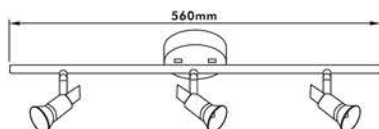

● TK17-3

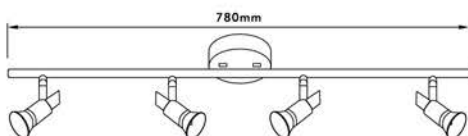

● TK17-4



Energy Saving Wall / Ceiling & Spot Light Fixture

- Material: Iron
- Lamp: GU10 COB 4W LED per Light (Bulb Incl.)
- Lumen: 400LM per Light (4000K)
- Finish: Chrome



● CK15A



● CK15A-3

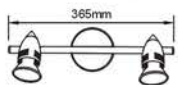
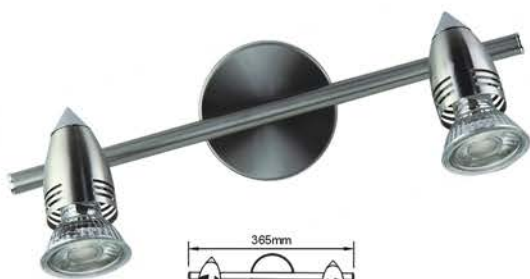

● TK15A-2

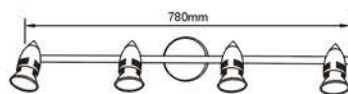

● TK15A-4



Wall & Ceiling Spotlight-Vista

- Material: Zinc Alloy + Iron
- Bulb Adaptable: GU10 6W LED Bulb 
- Finish: Chrome/Polished Brass/Satin Nickel/Satin Brass

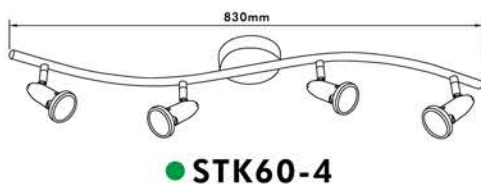

Wall & Ceiling Spotlight-Gino

- Material: Acid Glass + Zinc Alloy + Iron
- Bulb Adaptable: GU10 6W LED Bulb
- Finish: Satin Nickel/Satin Brass/Chrome
- Glass: Acid White & Acid Blue

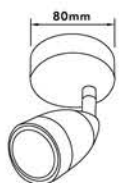

● CK90-1

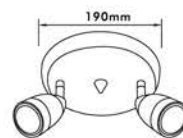

● CK90-2

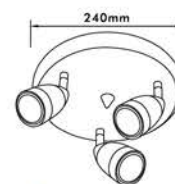

● CK90-3



● CTK90-3

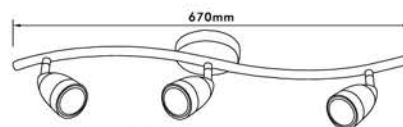

● STK90-3

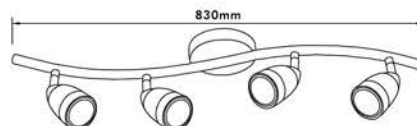

● STK90-4

Wall & Ceiling Spotlight-Nice

- Material: Pressed Iron + Opal Glass
- Bulb Adaptable: E14 5W LED Bulb + R50
- Finish: Chrome/Polished Brass/Satin Nickel/Satin Brass

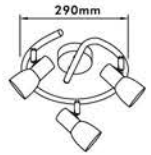

●● CTK94-3

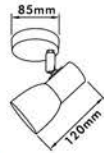

●● CK94-1



●● CK94-2

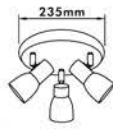

●● CK94-3

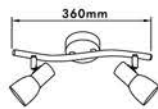

●● STK94-2

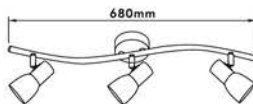

●● STK94-3

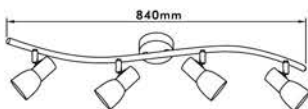

●● STK94-4



Wall & Ceiling Spotlight-Gloria.C

- Material: Zinc Alloy + Iron
- Bulb Adaptable: GU10 50W Max. 
GU10 C Class 40W 
GU10 LED 6W 
- Finish: Black/Satin Nickel/Satin Brass/Polished Brass

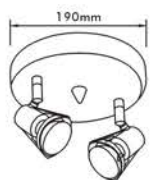

● CK10-2C



● CK10-1C

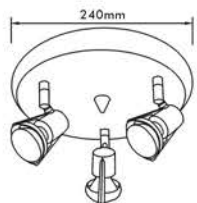

● CK10-3C

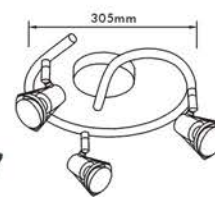

● CTK10-3

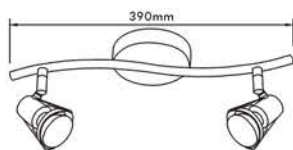

● STK10-2

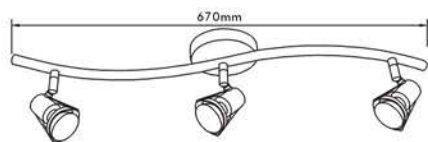

● STK10-3

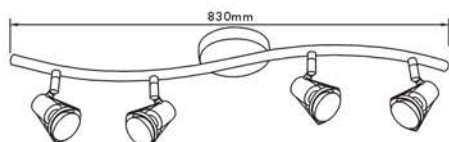

● STK10-4



**Interior
Cabinet Light
& Kitchen Light**

Home Resource 2017 Collection

Battery Operated LED Cabinet Light

- Material: ABS Body + Stainless Steel Bracket
- Lamp: 9 x 0.1W SMD3528 LED
- Lumen: 60LM (6000K)
- Battery: 3 x AA (Excl.)
- Battery operated Time: 8H
- Sensor: 130°, 20 Secs, 2~3M
- Push On/Off Switch
- Finish: White

CE  RoHS



2-in-1 Battery Operated LED Stick Light

- Material: Aluminum Body + ABS Base
- With 4pcs $\Phi 5$ LED
- 11000~13000MCD
- Battery: 3xAAA (Excl.)
- Finish: Black/White

CE EMC



LED Under Cabinet Light

- Material: ABS Fixture + PC Tube
- Voltage: AC 80V ~ 265V
- Lamp: 6W (60pcs x 0.1W SMD3014 LED)
- Luminous Flux: 350LM (3000K)
- Touch On/Off Switch
- Finish: White



Linkable LED Strip Sensor Light - Powered by USB Cable or Battery

- Set of 2
- Material: Plastic
- Voltage: DC 3.5V ~ 6V
- Lamp: 4W (12pcs x SMD2835 LED) per set
- Lumen Flux: 300LM (6700K)
- Color Temperature: 2700K ~ 6500K
- With PIR+CDF Sensor (1~3M, 60° , 30 Seconds or 1 Minute, Sensor only working in dark at illuminance 10~20 Lux)
- Sensor Switch with 2 Options: (1) 30-Second Time-Delay and (2) 1-Minute Time-Delay
- Accessories: (1) USB Cable (2) Battery Case (4pcs AAA batteries are excluded) (3) L-Connector
- Product Size: L.308 x W.8.5 x H.6.7mm per strip
- Finish: White

CE RoHS EMC
SGS

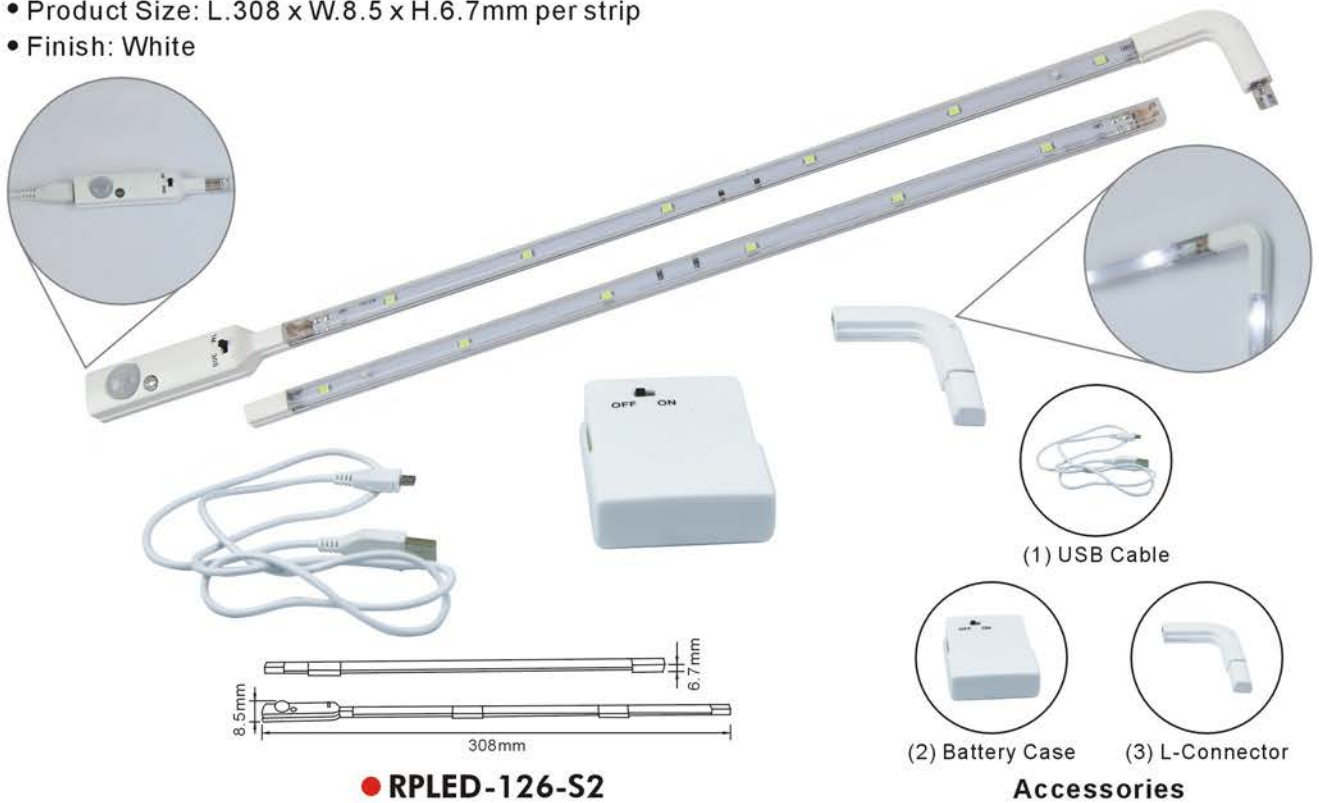

LED Under Cabinet Down Light

- Material: ABS
- Voltage: DC12V
- Beam Angle: 90°
- Finish: Gray

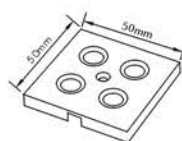

● DLED-850

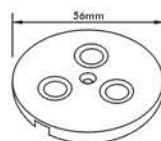

● DLED-851

Model No.	No. of LEDs	Watt	Luminous Flux
DLED-850	SMD 0.3 x 4	1.2W	100LM
DLED-851	SMD 0.3 x 3	1W	85LM

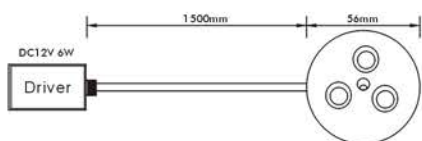

DLED-851

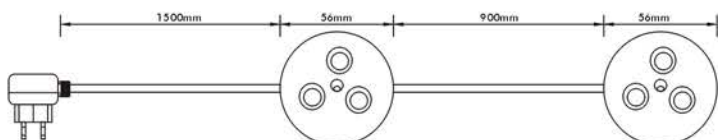

DLED-851-S2

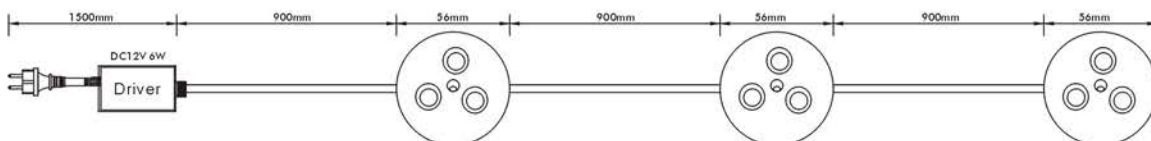

DLED-851-S3

LED Sensor Cabinet Light

- Material: ABS
- Color: White
- Battery: 3 x AAA (Excluded)
- With CDS (Photo sensor) & PIR Motion Sensor
- Switch: Auto / On / Off

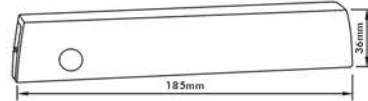

● BO-LED90

Lamp: 0.35W (5 x 0.07W LED)
Battery Working Time: 25H at "ON" mode

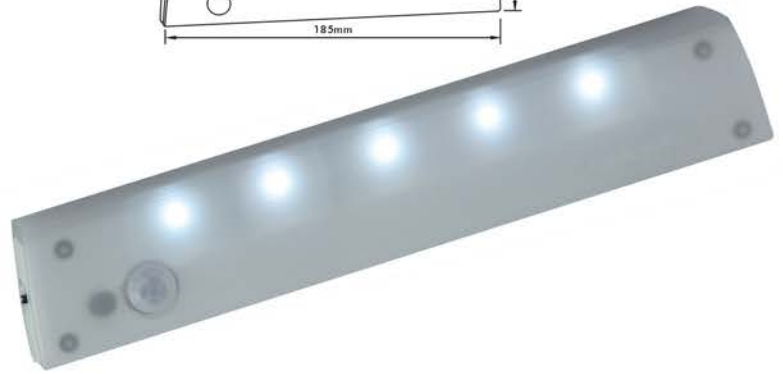

● BO-LED95

Lamp: 0.35W (5 x 0.07W LED)
Battery Working Time: 25H at "ON" mode
With Magnet

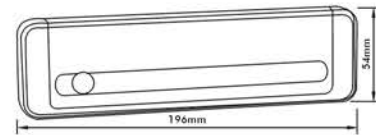

LED Sensor Cabinet Light

- Material: ABS
- Color: White
- With CDS (Photo sensor) & PIR Motion Sensor
- Switch: Auto / On / Off

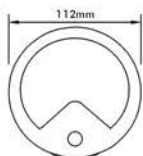

● BO-LED91

Lamp: 0.21W (3 x 0.07W LED)
Battery: 3 x AAA (Excluded)
Battery Working Time: 25H at "ON" mode



AUTO/ON/OFF Switch



● BO-LED92

Lamp: 0.5W (1 x 0.5W LED)
Battery: 3 x AA (Excluded)
Battery Working Time: 20H at "ON" mode

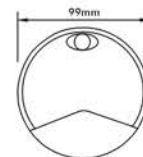

● BO-LED91A

Lamp: 0.21W (3 x 0.07W LED)
Battery: 3 x AAA (Excluded)
Battery Working Time: 25H at "ON" mode
Time Delay (adjustable): 20S/60S/90S
Sense adjustable
With Low power indicator
Dimmable



LED (Sensor) Cabinet Light

- Material: ABS
- Color: White

● BO-LED93

Lamp: 0.3W (1 x 0.3W LED)
Battery: 3 x AAA (Excluded)
Battery Working Time: 23H at "ON" mode
With CDS (Photo sensor) & PIR Motion Sensor
Switch: Auto / On / Off
With Magnet

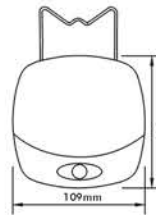
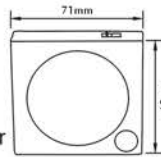

● BO-LED94

Lamp: 0.21W (3 x 0.07W LED)
Battery: 3 x AAA (Excluded)
Battery Working Time: 30H at "ON" mode
With CDS (Photo sensor) & PIR Motion Sensor
Switch: Auto / On / Off
With Magnet

● BO-LED96

Lamp: 0.5W (1 x 0.5W LED)
Battery: 3 x AA (Excluded)
Battery Working Time: 30H
Switch: Push On / Off

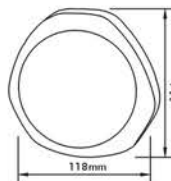

Linkable LED Strip Light Set / LED Cabinet Light Set-**Economic**

- Material: PU Resin
- Including LED driver, Line On/Off Switch, cable and connectors
- Color Temperature: 2700K ~ 6400K
- Ra>70
- Finish: White

Connector Accessories



(1) Linkable Lead

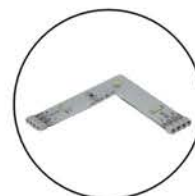

(2) L-Connector

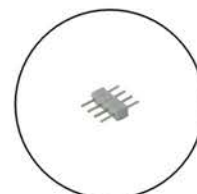

(3) Connector

● RPLED-123-S2

Lamp: 1W (12 x 0.08W SMD3528 LED) per strip x 2 strips
Lumen Flux: >70LM per strip x 2 strips (3000K)
Product size: L.300 x W.10 x H.3mm per strip



Set of 4

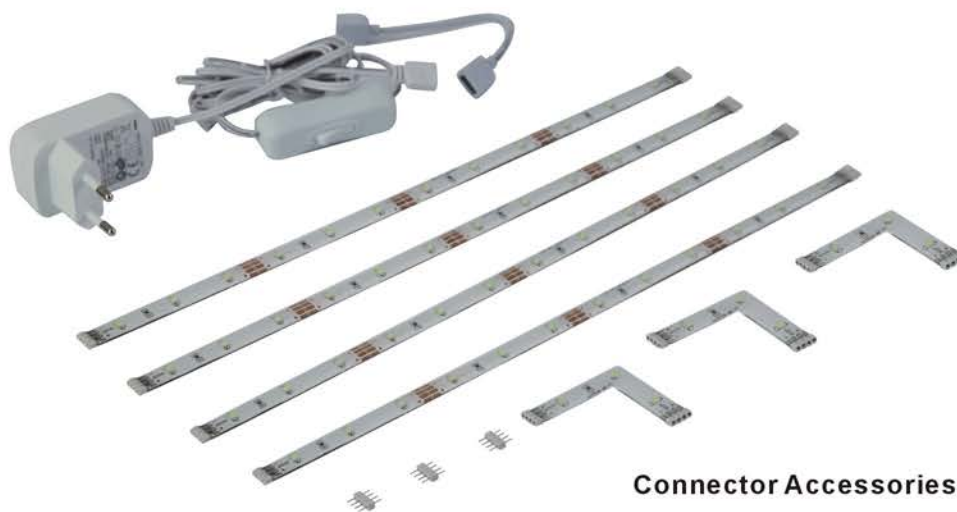

Connector Accessories



(1) Linkable Lead



(2) L-Connector

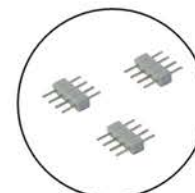

(3) Connector

● RPLED-123-S4

Lamp: 1W (12 x 0.08W SMD3528 LED) per strip x 4 strips
Lumen Flux: >70LM per strip x 4 strips (3000K)
Product size: L.300 x W.10 x H.3mm per strip

Linkable LED Strip Light Set / LED Cabinet Light Set-**Deluxe**

- Material: PU Resin
- Including LED driver, Line On/Off Switch, cable and connectors
- Color Temperature: 2700K ~ 6400K
- Ra>80
- Finish: White



● RPLED-123-S2

Lamp: 1W (12 x 0.08W SMD3528 LED) per strip x 2 strips
Lumen Flux: >70LM per strip x 2 strips (3000K)
Product size: L.300 x W.10 x W.3mm per strip



● RPLED-123-S4

Lamp: 1W (12 x 0.08W SMD3528 LED) per strip x 4 strips
Lumen Flux: >70LM per strip x 4 strips (3000K)
Product size: L.300 x W.10 x W.3mm per strip

Linkable LED Cabinet Light

- Material: Aluminum Body + Acrylic Duffuser
- CRI: Ra>80
- Color Temperature: 2800K~6500K
- Finish: Aluminum Anodized

CE  RoHS EMC
ErP FC



GS Adaptor
(I/P: 100~240V AC ;
O/P: 12V DC)

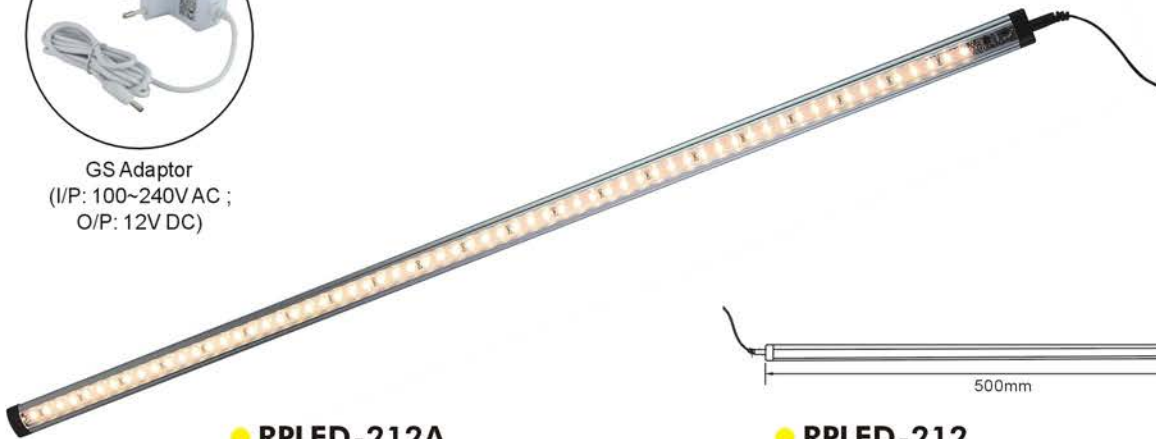

● RPLED-212A

Lamp: 8W (63 x 0.13W SMD2835 LED)/pc
Luminous Flux: 640LM (4000K at 100% brightness)
Product Size: L.800 x W.25 x H.9mm
4 Way Dimming: 6%-50%-100%-Off (Touch on metal part)
(Plug-in sockets are workable in 2-end, no polarity limit)

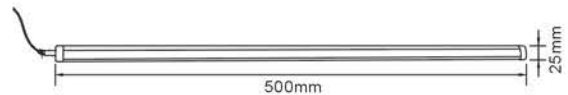

● RPLED-212

Lamp: 5W (39 x 0.13W SMD2835 LED)/pc
Luminous Flux: 400LM (4000K at 100% brightness)
Product Size: L.500 x W.25 x H.9mm
4 Way Dimming: 6%-50%-100%-Off (Touch on metal part)
(Plug-in sockets are workable in 2-end, no polarity limit)



● RPLED-213

Lamp: 7W (36 x 0.2W SMD5730 LED)/pc
Luminous Flux: 600LM (4000K at 100% brightness)
Product Size: L.500 x W.25 x H.16mm

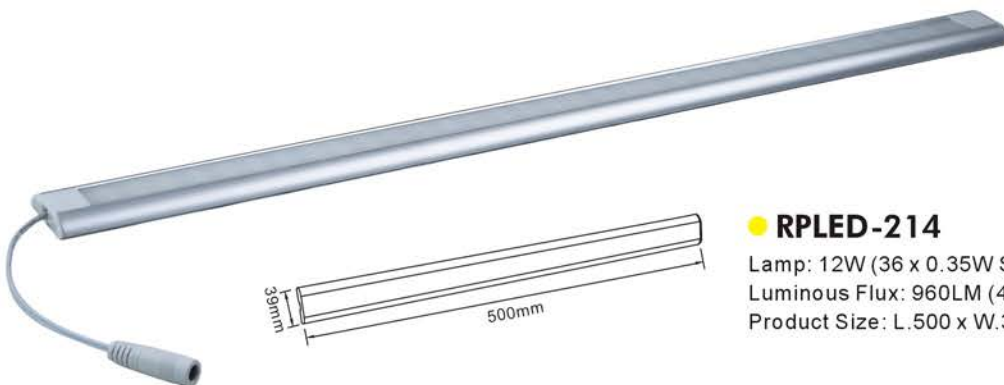
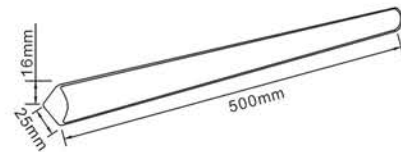

● RPLED-214

Lamp: 12W (36 x 0.35W SMD5730 LED)/pc
Luminous Flux: 960LM (4000K at 100% brightness)
Product Size: L.500 x W.39 x H.9mm

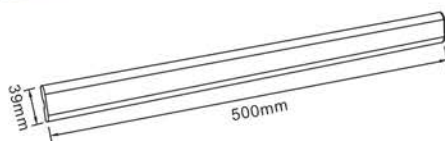

AC (driverless) LED Cabinet Light

- Material: Zinc Alloy + Iron + PC
- Lamp: AC type built-in 6W (3 x 20pcs 0.1W SMD3014) LED
- Lumen: 3 x 200LM (3000K)
- Input Voltage: AC 100~240V
- Finish: White / Black
- With 1.5M cable + plug
- With On/Off Switch



● DLED-700



Linkable LED Strip Light/LED Cabinet Light

- Material: PC base + PC diffuser
- Finish: White
- Input voltage: AC220-265V
- 1.5M white link mains cable + plug
- With 15cm connecting cable

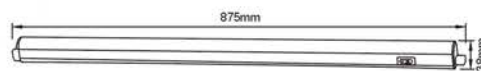

●	No. of Leds	Watt	Prod. Dimension	Luminous Flux
LLED-T504	20pcs 2835 LED	4	L313 x W22 x H38mm	360LM(4000K)
LLED-T508	40pcs 2835 LED	8	L575 x W22 x H38mm	680LM(4000K)
LLED-T510	50pcs 2835 LED	10	L875 x W22 x H38mm	865LM(4000K)

Under Cabinet Light

- Material: PC Fixture
- With T4 Tube lite & Switch
- With Built-in Electronic Ballast



Linkable



Item No	Watt	Lumen	Dimension(mm)		
			L	W	H
• LFT-406	6W	240	270	17	42
• LFT-410	10W	500	390	17	42
• LFT-416	16W	820	520	17	42
• LFT-420	20W	1120	620	17	42

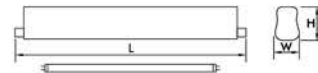

- Material: PVC Fixture
- With T5 Tube lite & Switch
- With Built-in Electronic Ballast



Linkable



Item No	Watt	Lumen	Dimension(mm)		
			L	W	H
• LFT-506	6W	240	267	22	42
• LFT-510	10W	500	458	22	42
• LFT-513	13W	820	571	22	42
• LFT-521	21W	1120	904	22	42
• LFT-528	28W	1846	1204	22	42

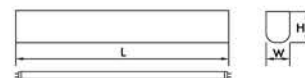

Accessories



Acrylic Diffuser



1.8M Cable + Plug



Link Lead(For Models LFT-406/410/416/420)
With 1 Male & 1 Female Connectors
(Available in 150mm, 250mm, 500mm, 1000mm)

LED Kitchen Light Kit

SMD version is optional

- Material: Iron Body
- Lamp: 0.36W (6 x 0.06W Φ 5 LED)
- Finish: Satin Nickel/Chrome/P. Brass

Low Voltage 12V
Number & Watts For LEDS Vary And
Are Upon Request.

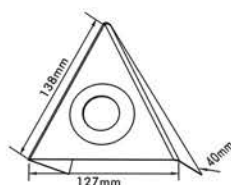

● **DLED-31**

• Accessories



- Indoor Transformer
I/P 230V or 110-130V, O/P 12V
- W/5M 20AWG Extension Cable



LED Lamp Data

LED Emitting Color	Angle	Luminous Intensity	Average Life
Green	120°	1500mcd	70000hrs
White	120°	1500mcd	70000hrs
Blue	120°	450mcd	70000hrs
Red	120°	600mcd	70000hrs
Amber	120°	600mcd	70000hrs

AC (driverless) LED Cabinet Light Kit

- Set of 3
- Lamp: Each head with AC type built-in 1.5W (27pcs 0.05W SMD3528) LED
- Lumen: 100LM/Head (3000K)
- Input Voltage: AC 170~240V
- Finish: Satin Nickel
- Each head with 1.5M Cable

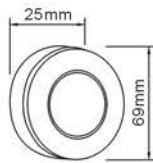

● **DLED-20C-S3**
Zinc Alloy + Iron + PC

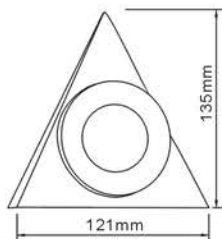

● **DLED-31C-S3**
Stainless Steel + Iron + PC



Under Cabinet Light

- Material: Pressed Iron + Glass
- Bulb Adaptable: 12V G4 3.5W LED Bulb Incl.

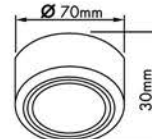

● DL-61



◆ Assembly

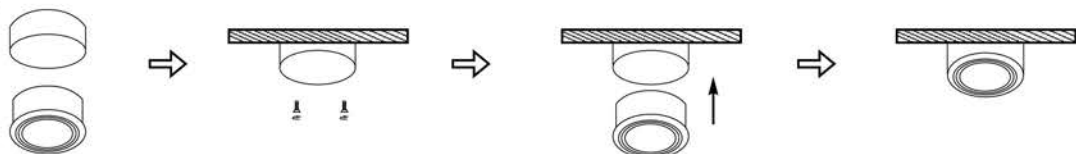

**Interior
Picture Light
& Display Light**

Home Resource 2017 Collection

LED Picture Light

- Material: Stainless Steel
- Finish: Chrome

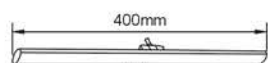

● **PLED-138(5W)**
Lamp: 5W (21 x SMD5050 LED)

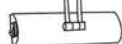
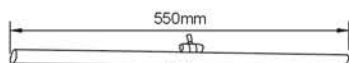

● **PLED-138(7W)**
Lamp: 7W (30 x SMD5050 LED)



Battery Operated LED Picture Light

-Piano Series

Patented

- Material: Iron Body
- Lamp: 0.54W (9 x 0.06W Φ 5 LED)
- Luminous flux: 48Lm(4000K)
- Finish: Satin Nickel/Chrome
- Battery: 3 xAA (Excl.)
- Operating Time: 36H (Alkaline Batteries)

Battery Operation

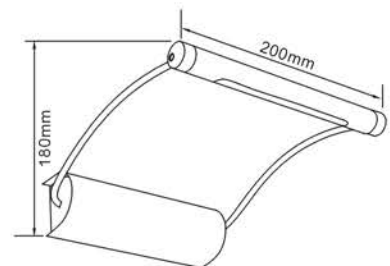

● PLED13-9A

- Mobile
(No electrical wire connecting demand)
- User friendly
(Magnet cover for replacing battery)
- UV & Heat free for pictures



LED Picture Light

-Piano Series

- Material: Iron Body
- Finish: Satin Nickel/Chrome

Patented

Low Voltage 12V

Number & Watts For LEDs Vary And Are Upon Request.

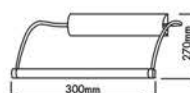

● **PLED-13/12**
Lamp: 0.72W (12 x 0.06W Φ 5 LED)
Luminous flux: 60Lm(4000K)

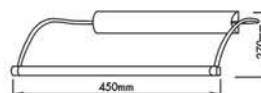

● **PLED-13/18**
Lamp: 1W (18 x 0.06W Φ 5 LED)
Luminous flux: 90Lm(4000K)

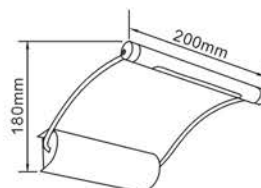

● **PLED-13/9**
Lamp: 0.54W (9 x 0.06W Φ 5 LED)
Luminous flux: 48Lm(4000K)



LED Picture Light

- Material: Aluminum Alloy + Acrylic
- Finish: Black/White/Silver
- LED Color Temperature: 3000K

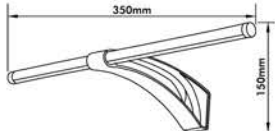

● PLED-15S

Lamp: 1.2W (18 x SMD3020 LED)
Illumination: 300 lux (0.3 meter distance)
Luminous Flux: 68Lm

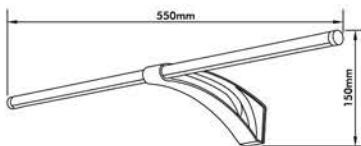

● PLED-15L

Lamp: 2.4W (36 x SMD3020 LED)
Illumination: 400 lux (0.3 meter distance)
Luminous Flux: 135Lm



LED Display Light

● DPLED-15S

Lamp: 1.2W (18 x SMD3020 LED)
Illumination: 300 lux (0.3 meter distance)
Luminous Flux: 68Lm

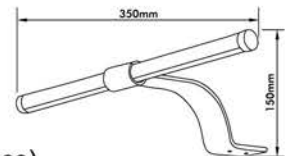

● DPLED-15L

Lamp: 2.4W (36 x SMD3020 LED)
Illumination: 400 lux (0.3 meter distance)
Luminous Flux: 135Lm

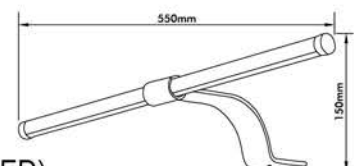

Interior

Bathroom Light

Home Resource 2017 Collection

Driver Built-in LED Bathroom Over Mirror Light

- Material: Aluminum Base + PMMA Diffuser + Stainless Steel Spring Clips
- Voltage: 85V ~ 265V
- Lamp: 10W (20 x 0.5W SMD5630 LED)
- Lumen: 800LM (3000K)
- With Pulling Switch
- Finish: Silver Body + White Diffuser
- IP44

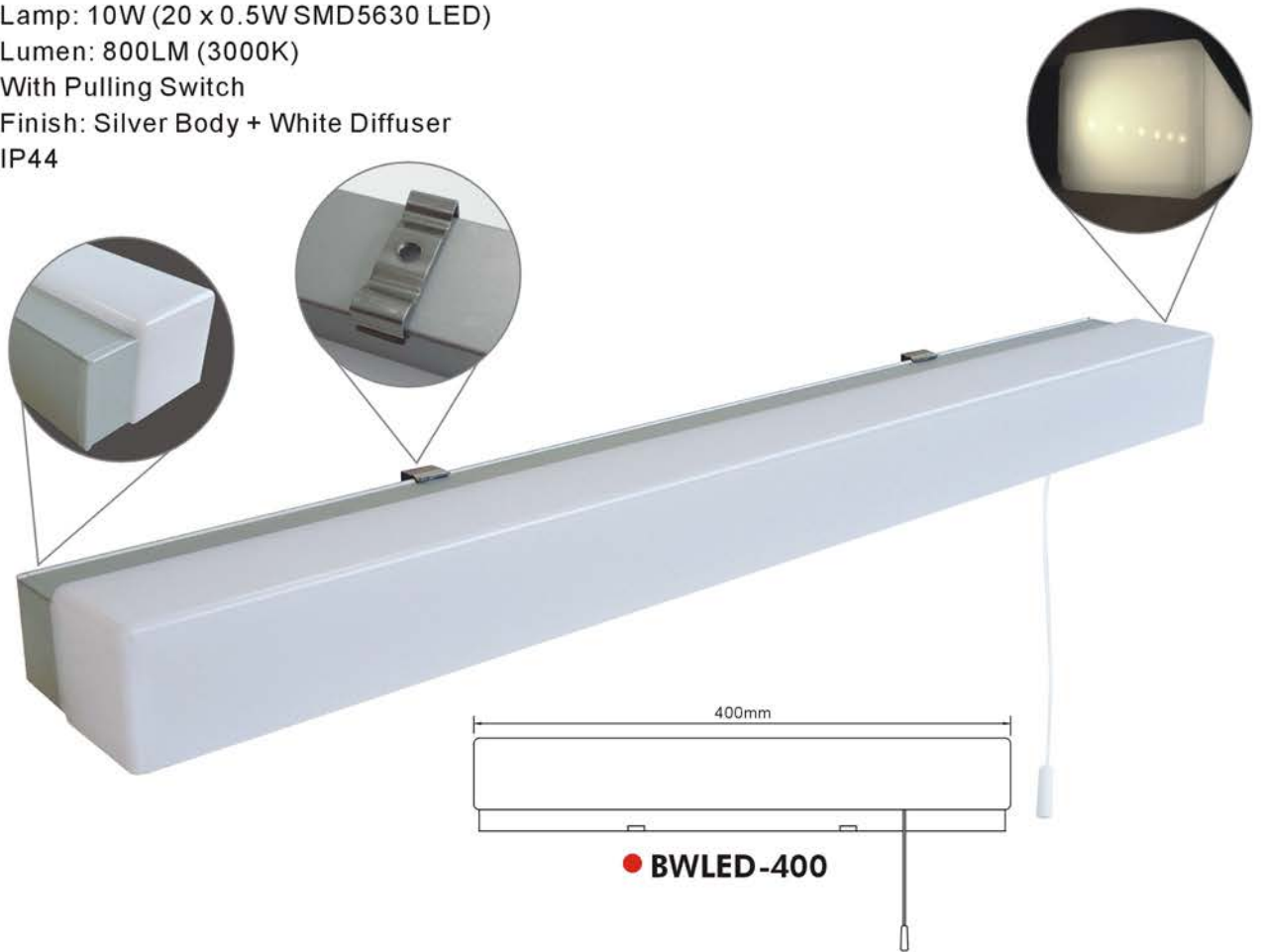

Driver Built-in LED Bathroom Over Mirror Light-Acrylic Series

- Material: Stainless Steel Housing + Acrylic Diffuser
- Voltage: 100V ~ 240V
- Color Temperature: 3000K ~ 6000K
- 65LM/W

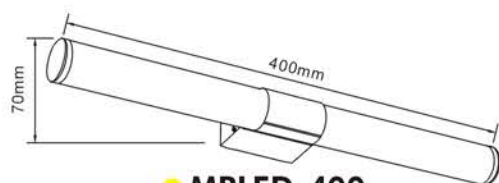

● **MRLED-400**

●	Lamp	Lumen	IP	Product size
MRLED-400(8W)	8W (40pcs x SMD2835 LED)	520LM(6000K)	IP44	L. 40 x W. 7 x H. 10cm
MRLED-400(10W)	10W (50pcs x SMD2835 LED)	650LM(6000K)	IP44	L. 46 x W. 7 x H. 10cm
MRLED-400(12W)	12W (60pcs x SMD2835 LED)	780LM(6000K)	IP44	L. 60 x W. 7 x H. 10cm
MRLED-400(16W)	16W (80pcs x SMD2835 LED)	1040LM(6000K)	IP44	L. 80 x W. 7 x H. 10cm
MRLED-400(24W)	24W (120pcs x SMD2835 LED)	1560LM(6000K)	IP44	L. 100 x W. 7 x H. 10cm



● **MRLED-401**

●	Lamp	Lumen	IP	Product size
MRLED-401(9W)	9W (45pcs x SMD2835 LED)	585LM(6000K)	IP20	L. 39.5 x W. 4 x H. 7cm
MRLED-401(12W)	12W (60pcs x SMD2835 LED)	780LM(6000K)	IP20	L. 49.5 x W. 4 x H. 7cm
MRLED-401(14W)	14W (70pcs x SMD2835 LED)	910LM(6000K)	IP20	L. 59.5 x W. 4 x H. 7cm
MRLED-401(16W)	16W (80pcs x SMD2835 LED)	1040LM(6000K)	IP20	L. 69.5 x W. 4 x H. 7cm
MRLED-401(20W)	20W (100pcs x SMD2835 LED)	1300LM(6000K)	IP20	L. 89.5 x W. 4 x H. 7cm

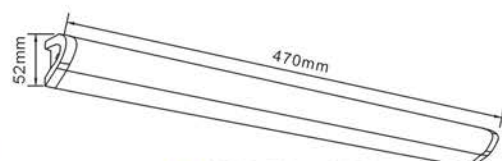

● **MRLED-403**

●	Lamp	Lumen	IP	Product size
MRLED-403(5W)	5W (25pcs x SMD2835 LED)	325LM(6000K)	IP20	L. 47 x W. 5.2 x H. 5.5cm
MRLED-403(7W)	7W (35pcs x SMD2835 LED)	455LM(6000K)	IP20	L. 60 x W. 5.2 x H. 5.5cm

Driver Built-in LED Bathroom Over Mirror Light-Acrylic Series

- Material: Stainless Steel Housing + Acrylic Diffuser
- Voltage: 100V ~ 240V
- Color Temperature: 3000K ~ 6000K
- 65LM/W
- IP20

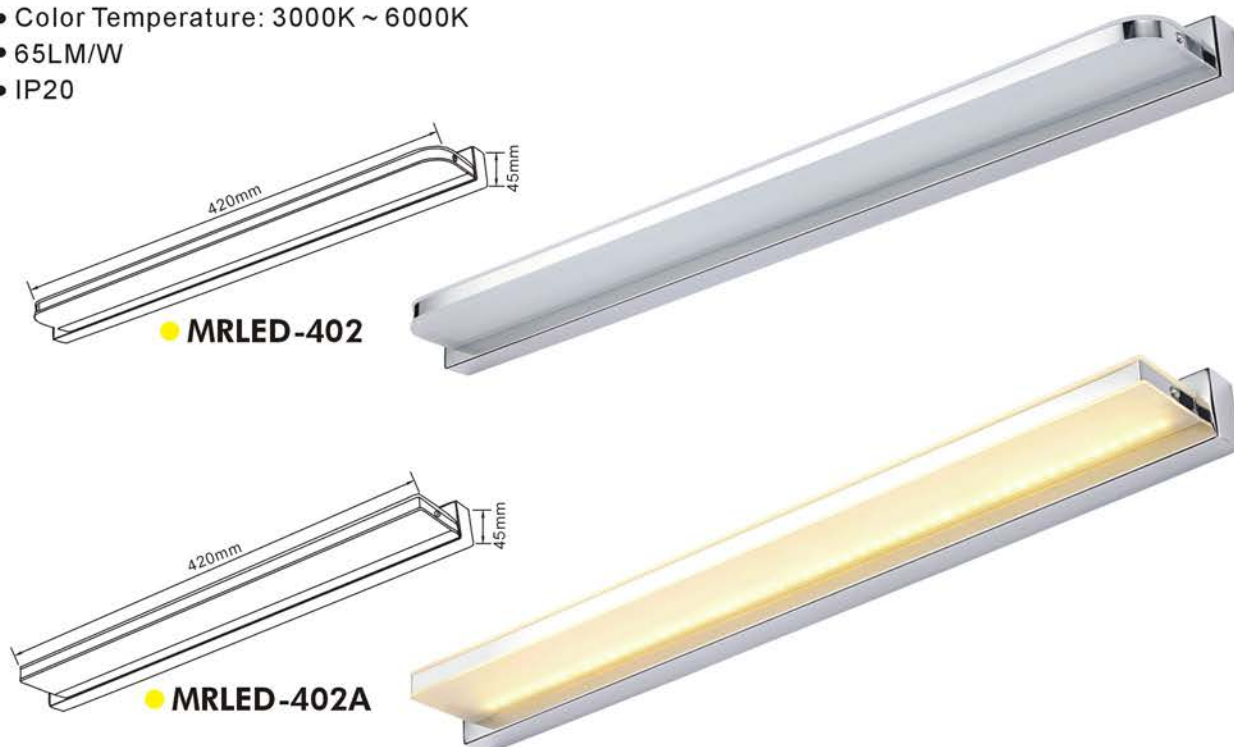

		Lamp	Lumen	Product size
● MRLED-402(9W)	● MRLED-402A(9W)	9W (45pcs x SMD2835 LED)	585LM(6000K)	L. 42 x W. 4.5 x H. 8.5cm
MRLED-402(12W)	MRLED-402A(12W)	12W (60pcs x SMD2835 LED)	780LM(6000K)	L. 52 x W. 4.5 x H. 8.5cm
MRLED-402(14W)	MRLED-402A(14W)	14W (70pcs x SMD2835 LED)	910LM(6000K)	L. 62 x W. 4.5 x H. 8.5cm
MRLED-402(16W)	MRLED-402A(16W)	16W (80pcs x SMD2835 LED)	1040LM(6000K)	L. 72 x W. 4.5 x H. 8.5cm
MRLED-402(20W)	MRLED-402A(20W)	20W (100pcs x SMD2835 LED)	1300LM(6000K)	L. 92 x W. 4.5 x H. 8.5cm
MRLED-402(24W)	MRLED-402A(24W)	24W (120pcs x SMD2835 LED)	1560LM(6000K)	L. 110 x W. 4.5 x H. 8.5cm



Driver Built-in LED Bathroom Over Mirror Light-Metal Series

- Voltage: 100V ~ 240V
- Color Temperature: 3000K ~ 6000K
- 65LM/W
- IP20



●	Material	Lamp	Lumen	Product size
●	Stainless Steel	3W (12pcs x SMD2835 LED)	195LM(6000K)	L. 28 x W. 5.5 x H. 14cm
●	Stainless Steel	5W (21pcs x SMD2835 LED)	325LM(6000K)	L. 40 x W. 5.5 x H. 14cm
●	Stainless Steel	7W (30pcs x SMD2835 LED)	455LM(6000K)	L. 55 x W. 5.5 x H. 14cm
●	Stainless Steel	9W (39pcs x SMD2835 LED)	585LM(6000K)	L. 70 x W. 5.5 x H. 14cm
●	Stainless Steel	12W (60pcs x SMD2835 LED)	780LM(6000K)	L. 105 x W. 5.5 x H. 14cm

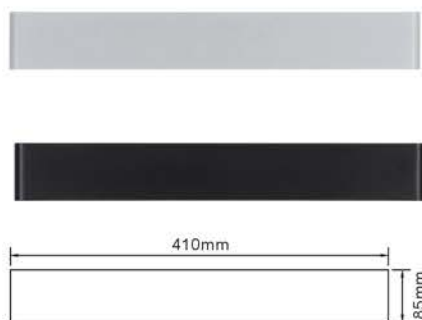

● **MRLED-404 (14W)**

●	Material	Lamp	Lumen	Product size
●	Aluminum	6W (30pcs x SMD2835 LED)	390LM(6000K)	L. 24 x W. 8.5 x H. 3cm
●	Aluminum	14W (70pcs x SMD2835 LED)	910LM(6000K)	L. 41 x W. 8.5 x H. 3cm
●	Aluminum	20W (100pcs x SMD2835 LED)	1300LM(6000K)	L. 61 x W. 8.5 x H. 3cm
●	Aluminum	24W (120pcs x SMD2835 LED)	1560LM(6000K)	L. 72 x W. 8.5 x H. 3cm
●	Aluminum	30W (150pcs x SMD2835 LED)	1950LM(6000K)	L. 91 x W. 8.5 x H. 3cm
●	Aluminum	36W (180pcs x SMD2835 LED)	2340LM(6000K)	L. 111 x W. 8.5 x H. 3cm

LED Interior Kitchen & Bathroom Light

- Material: Iron + PMMA
- Lamp: 10W (20 x 0.5W SMD5730 LED)
- Lumen: 70-75LM/W
- Color Temperature: 3000/4000/6000K
- With Built-in driver
- Finish: White
- IP44

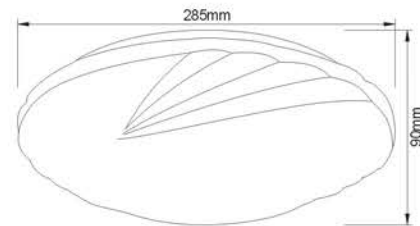

● CMLED-540

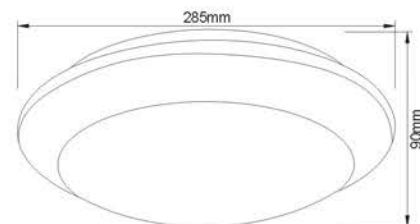

● CMLED-541

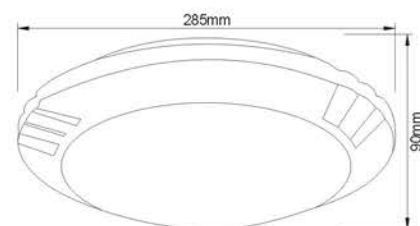

● CMLED-542

LED Bathroom Ceiling Lamp

- Material: ABS + PC
- Lamp: 36 x 0.45W LED(SMD5630)
- LED Beam Angle: 120°
- White, Chrome, Silver Interchangeable Trims
- Built-in Driver
- IP65



● **CMLED-532**

Luminous Flux: Warm White 1615Lm
Cool White 1700Lm





- Lamp: 24 x 0.45W LED(SMD5630)



● **CMLED-533**

Luminous Flux: Warm White 1092Lm
Cool White 1150Lm

Bathroom Ceiling Lamp

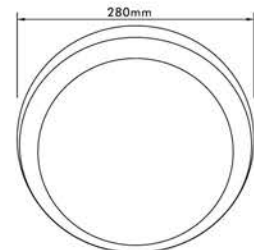

- Material: Iron Ring + Opal Glass + Iron Base
- Bulb Adaptable: E27 40W Max. 
E27 ESB T3/13W max. Spiral 
E27 C Class 28W 
E27 LED 6W 
- IP44



● CF-09S



Bathroom Down Light

- Material: Iron + Tempered Glass
- Bulb Adaptable: MR16 5W LED Bulb 
GU10 5W LED Bulb 
- IP44



● **DL-90**
MR16 5W LED Bulb 

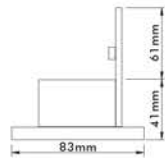

● **DL-90G**
GU10 5W LED Bulb 

Zone 1 - IP65 / Zone 2 - IP44 / Zone 3 - IP20/IP23

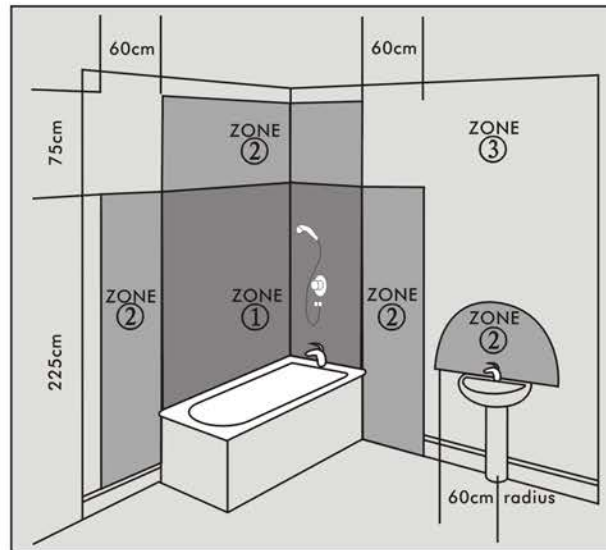

Interior Ceiling Light

Home Resource 2017 Collection

LED Interior Ceiling Lamp-Economic

Built-in EMC Driver

CE EMC

- Material: Steel Base + PMMA Diffuser
- Voltage: 220V ~ 240V
- Color Temperature: 2700K ~ 6500K
- Finish: White
- IP20

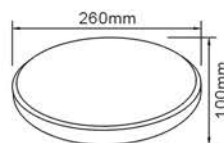

●	Lamp	Lumen	Product size
CFLED-S121	12W (24 x 0.5W SMD5730 LED)	840LM (4000K)	Dia. 26 x H. 10cm
CFLED-M121	16W (32 x 0.5W SMD5730 LED)	1120LM (4000K)	Dia. 33 x H. 10cm
CFLED-L121	20W (40 x 0.5W SMD5730 LED)	1400LM (4000K)	Dia. 39 x H. 10cm

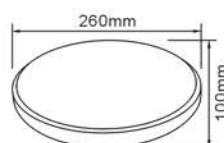

●	Lamp	Lumen	Product size
CFLED-S122	12W (24 x 0.5W SMD5730 LED)	840LM (4000K)	Dia. 26 x H. 10cm
CFLED-M122	16W (32 x 0.5W SMD5730 LED)	1120LM (4000K)	Dia. 33 x H. 10cm
CFLED-L122	20W (40 x 0.5W SMD5730 LED)	1400LM (4000K)	Dia. 39 x H. 10cm

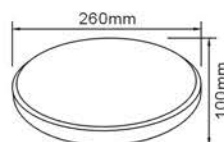

●	Lamp	Lumen	Product size
CFLED-S123	12W (24 x 0.5W SMD5730 LED)	840LM (4000K)	Dia. 26 x H. 10cm
CFLED-M123	16W (32 x 0.5W SMD5730 LED)	1120LM (4000K)	Dia. 33 x H. 10cm
CFLED-L123	20W (40 x 0.5W SMD5730 LED)	1400LM (4000K)	Dia. 39 x H. 10cm

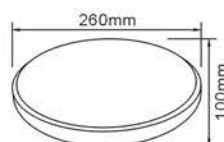

●	Lamp	Lumen	Product size
CFLED-S124	12W (24 x 0.5W SMD5730 LED)	840LM (4000K)	Dia. 26 x H. 10cm
CFLED-M124	16W (32 x 0.5W SMD5730 LED)	1120LM (4000K)	Dia. 33 x H. 10cm
CFLED-L124	20W (40 x 0.5W SMD5730 LED)	1400LM (4000K)	Dia. 39 x H. 10cm

LED Interior Ceiling Lamp - Built-in LED Driver



- Material: Steel Base + PMMA Diffuser
- Voltage: 180V ~ 265V
- Color Temperature: 3000K ~ 6500K
- Finish: White



●	Lamp	Lumen	Product size
CFLED-S536	6W(32pcs x SMD2835 LED)	420LM(4000K)	Dia. 21.5 x H. 7cm
CFLED-S536	12W(26pcs x SMD2835 LED)	850LM(4000K)	Dia. 26 x H. 8cm
CFLED-M536	18W(39pcs x SMD2835 LED)	1250LM(4000K)	Dia. 34 x H. 9.2cm
CFLED-L536	24W(52pcs x SMD2835 LED)	1450LM(4000K)	Dia. 40 x H. 10.2cm

Dimming Version

●	Lamp	Lumen	Product size
CFLED-S536	12W(26pcs x SMD2835 LED)	850LM(4000K)	Dia. 26 x H. 8cm
CFLED-M536	18W(39pcs x SMD2835 LED)	1250LM(4000K)	Dia. 34 x H. 9.2cm
CFLED-L536	24W(52pcs x SMD2835 LED)	1450LM(4000K)	Dia. 40 x H. 10.2cm

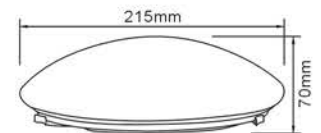

● **CFLED-S536**

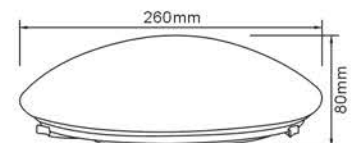

● **CFLED-S536S**



Microwave sensor Version

●	Lamp	Lumen	Product size
CFLED-S536S	12W(26pcs x SMD2835 LED)	850LM(4000K)	Dia. 26 x H. 8cm
CFLED-M536S	18W(39pcs x SMD2835 LED)	1250LM(4000K)	Dia. 34 x H. 9.2cm
CFLED-L536S	24W(52pcs x SMD2835 LED)	1450LM(4000K)	Dia. 40 x H. 10.2cm

With microwave-sensor, Sensor distance: 8M, Sensor angle: 120°, Sensor delay time: 25S

LED Interior Ceiling Lamp-Economic - Built-in LED Driver



- Material: Steel Base + PMMA Diffuser
- Color Temperature: 2700K~6500K
- Voltage: AC 100V ~ 240V
- Finish: White



	Lamp	Lumen	Product size
CMLED-S535A(8W)	8W(20pcs x SMD2835 LED)	750LM(4000K)	Dia. 26 x H. 9.5cm
CMLED-S535A(12W)	12W(28pcs x SMD2835 LED)	1150LM(4000K)	Dia. 26 x H. 9.5cm
CMLED-S535A(15W)	15W(30pcs x SMD2835 LED)	1450LM(4000K)	Dia. 26 x H. 9.5cm
CMLED-535A	18W(40pcs x SMD2835 LED)	1750LM(4000K)	Dia. 30 x H. 9.5cm
CMLED-M535A	24W(48pcs x SMD2835 LED)	2350LM(4000K)	Dia. 35 x H. 9.5cm



	Lamp	Lumen	Product size
CMLED-S535B(8W)	8W(20pcs x SMD2835 LED)	750LM(4000K)	Dia. 26 x H. 8cm
CMLED-S535B(12W)	12W(28pcs x SMD2835 LED)	1150LM(4000K)	Dia. 26 x H. 8cm
CMLED-S535B(15W)	15W(30pcs x SMD2835 LED)	1450LM(4000K)	Dia. 26 x H. 8cm
CMLED-535B	18W(40pcs x SMD2835 LED)	1750LM(4000K)	Dia. 30 x H. 8cm
CMLED-M535B	24W(48pcs x SMD2835 LED)	2350LM(4000K)	Dia. 35 x H. 8cm



	Lamp	Lumen	Product size
CMLED-S535C(8W)	8W(20pcs x SMD2835 LED)	750LM(4000K)	Dia. 26 x H. 10cm
CMLED-S535C(12W)	12W(28pcs x SMD2835 LED)	1150LM(4000K)	Dia. 26 x H. 10cm
CMLED-S535C(15W)	15W(30pcs x SMD2835 LED)	1450LM(4000K)	Dia. 26 x H. 10cm
CMLED-535C	18W(40pcs x SMD2835 LED)	1750LM(4000K)	Dia. 30 x H. 10cm
CMLED-M535C	24W(48pcs x SMD2835 LED)	2350LM(4000K)	Dia. 35 x H. 10cm



	Lamp	Lumen	Product size
CMLED-S535D(8W)	8W(20pcs x SMD2835 LED)	750LM(4000K)	Dia. 26 x H. 11cm
CMLED-S535D(12W)	12W(28pcs x SMD2835 LED)	1150LM(4000K)	Dia. 26 x H. 11cm
CMLED-S535D(15W)	15W(30pcs x SMD2835 LED)	1450LM(4000K)	Dia. 26 x H. 11cm
CMLED-535D	18W(40pcs x SMD2835 LED)	1750LM(4000K)	Dia. 30 x H. 11cm
CMLED-M535D	24W(48pcs x SMD2835 LED)	2350LM(4000K)	Dia. 35 x H. 11cm

Interior Ceiling Lamp

- Material: Iron + Glass
- Bulb Adaptable: 1 or 2 E27 4W LED Bulb A type 
- With three plastic clips
- Finish: White

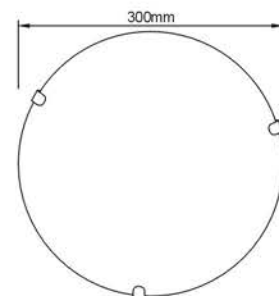

● **CM-665A-2**
2 x E27 4W LED Bulb

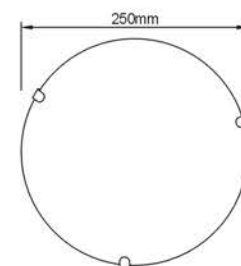

● **CM-665A**
1 x E27 4W LED Bulb

Interior Panel Light / Down Light

Home Resource 2017 Collection

LED Panel Light-Standard Version

- Material: Aluminum + PC
- Voltage: 160V ~ 260V
- Color Temperature: 3000K ~ 6500K
- Lamp: 36W (180 x 0.2W SMD4014 LED)
- Lumen: 2900LM (3000K)
- Finish: Silver

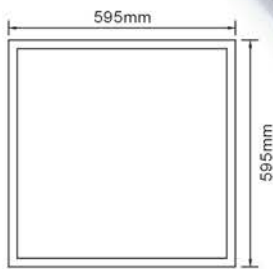

● ● PALED-6060J

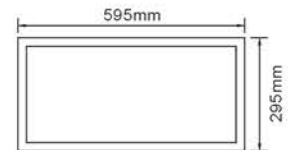

● ● PALED-3060J



Super Slim Driver Integrated LED Down Light

CE EMC

- Material: Aluminum
- Color Temperature: 3000K ~ 6000K
- Finish: White



●	Lamp	Lumen	Product size	Cut out size
DLED-874(8W)	8W(30pcs x SMD4014 LED)	800LM(4000K)	Dia. 9 x H. 2.2cm	Dia. 7cm
DLED-874(16W)	16W(60pcs x SMD4014 LED)	1600LM(4000K)	Dia. 14.5 x H. 2.2cm	Dia. 12.5cm
DLED-874(22W)	22W(90pcs x SMD4014 LED)	2200LM(4000K)	Dia. 17.3 x H. 2.2cm	Dia. 15.2cm
DLED-874(30W)	30W(120pcs x SMD4014 LED)	3000LM(4000K)	Dia. 22 x H. 2.2cm	Dia. 18.5cm



●	Lamp	Lumen	Product size	Cut out size
DLED-875(8W)	8W(30pcs x SMD4014 LED)	800LM(4000K)	L. 9 x W. 9 x H. 2.2cm	L. 7 x W. 7cm
DLED-875(16W)	16W(60pcs x SMD4014 LED)	1600LM(4000K)	L. 14.5 x W. 14.5 x H. 2.2cm	L. 12.5 x W. 12.5cm
DLED-875(22W)	22W(90pcs x SMD4014 LED)	2200LM(4000K)	L. 17.3 x W. 17.3 x H. 2.2cm	L. 15.2 x W. 15.2cm
DLED-875(30W)	30W(120pcs x SMD4014 LED)	3000LM(4000K)	L. 22 x W. 22 x H. 2.2cm	L. 18.5 x W. 18.5cm

LED Small Panel Down Light-Deluxe

- Material: Aluminum Body + Acrylic Diffuser
- Voltage: AC 85V~265V
- Color Temperature: 2700K ~ 6500K
- Finish: White

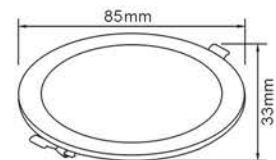

● **DLED-872**

●	Lamp	Lumen	Product size	Cut out size
DLED-872(3W)	3W(15pcs x SMD2835 LED)	180LM(4000K)	Dia. 8.5 x H. 3.3cm	Dia. 7cm
DLED-872(4W)	4W(20pcs x SMD2835 LED)	260LM(4000K)	Dia. 10.5 x H. 3.3cm	Dia. 9.5cm
DLED-872(6W)	6W(30pcs x SMD2835 LED)	410LM(4000K)	Dia. 12 x H. 3.3cm	Dia. 10.5cm
DLED-872(9W)	9W(45pcs x SMD2835 LED)	610LM(4000K)	Dia. 14.5 x H. 3.3cm	Dia. 13cm
DLED-872(15W)	15W(75pcs x SMD2835 LED)	1180LM(4000K)	Dia. 19 x H. 3.3cm	Dia. 17.5cm
DLED-872(24W)	24W(120pcs x SMD2835 LED)	2100LM(4000K)	Dia. 30 x H. 3.3cm	Dia. 28.5cm

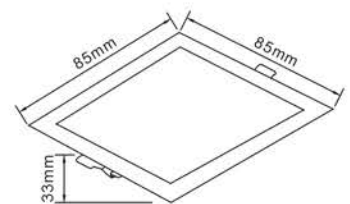

● **DLED-873**

●	Lamp	Lumen	Product size	Cut out size
DLED-873(3W)	3W(15pcs x SMD2835 LED)	180LM(4000K)	L. 8.5 x W. 8.5 x H. 3.3cm	L. 7 x W. 7cm
DLED-873(4W)	4W(20pcs x SMD2835 LED)	260LM(4000K)	L. 10.5 x W. 10.5 x H. 3.3cm	L. 9.5 x W. 9.5cm
DLED-873(6W)	6W(30pcs x SMD2835 LED)	410LM(4000K)	L. 12 x W. 12 x H. 3.3cm	L. 10.5 x W. 10.5cm
DLED-873(9W)	9W(45pcs x SMD2835 LED)	610LM(4000K)	L. 14.5 x W. 14.5 x H. 3.3cm	L. 13 x W. 13cm
DLED-873(15W)	15W(75pcs x SMD2835 LED)	1180LM(4000K)	L. 19 x W. 19 x H. 3.3cm	L. 17.5 x W. 17.5cm
DLED-873(24W)	24W(120pcs x SMD2835 LED)	2100LM(4000K)	L. 30 x W. 30 x H. 3.3cm	L. 28 x W. 28cm

Driver Built-in LED Down Light

Color Temperature Optional-3000K(WW)-4000K(NW)-6000K(CW)

- Material: Plastic Housing
- Voltage: 100V ~ 240V
- Finish: White



RoHS EMC

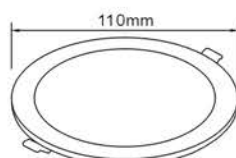

● **DLED-S65**



●	Lamp	Lumen	Product size	Cut out size
DLED-S65(3W)	3W (6 x 3000K + 6 x 6000K SMD2835 LED)	270LM(4000K)	Dia. 11 x H. 5.3cm	Dia. 8-8.5cm
DLED-S65(5W)	5W (10 x 3000K + 10 x 6000K SMD2835 LED)	440LM(4000K)		
DLED-S65(7W)	7W (14 x 3000K + 14 x 6000K SMD2835 LED)	600LM(4000K)		
DLED-S65(10W)	10W (20 x 3000K + 20 x 6000K SMD2835 LED)	850LM(4000K)		

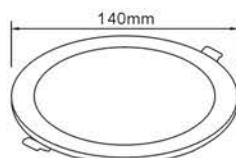

● **DLED-M65**



●	Lamp	Lumen	Product size	Cut out size
DLED-M65(13W)	13W (26 x 3000K + 26 x 6000K SMD2835 LED)	1150LM(4000K)	Dia. 14 x H. 7cm	Dia. 11-12cm
DLED-M65(15W)	15W (30 x 3000K + 30 x 6000K SMD2835 LED)	1350LM(4000K)		

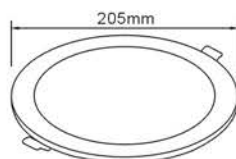

● **DLED-L65**



●	Lamp	Lumen	Product size	Cut out size
DLED-L65(18W)	18W (36 x 3000K + 36 x 6000K SMD2835 LED)	1650LM(4000K)	Dia. 20.5 x H. 7cm	Dia. 14-15cm
DLED-L65(20W)	20W (40 x 3000K + 40 x 6000K SMD2835 LED)	1750LM(4000K)		

IP44 Driver Built-in LED Down Light

- Material: PC Housing
- Voltage: 220V ~ 240V
- Color Temperature: 2800K ~ 6800K
- Color: White + White/Orange/Blue
- IP44 (Recessed part IP20 / Non-recessed part Ip44)



● **DLED-63**

●	Lamp	Lumen	Product size	Cut out size
DLED-63(5W)	5W(5pcs x 1W SMD2825 LED)	350LM(4000K)	Dia. 9.5 x H. 5.75cm	Dia. 6.8-8cm
DLED-63(8W)	8W(8pcs x 1W SMD2825 LED)	560LM(4000K)	Dia. 9.5 x H. 5.75cm	Dia. 6.8-8cm
DLED-63(10W)	10W(10pcs x 1W SMD2825 LED)	700LM(4000K)	Dia. 11.3 x H. 5.9cm	Dia. 9-10cm
DLED-63(12W)	12W(12pcs x 1W SMD2825 LED)	840LM(4000K)	Dia. 11.3 x H. 5.9cm	Dia. 9-10cm
DLED-63(14W)	14W(14pcs x 1W SMD2825 LED)	1100LM(4000K)	Dia. 14.5 x H. 6.58cm	Dia. 12-13cm
DLED-63(17W)	17W(17pcs x 1W SMD2825 LED)	1300LM(4000K)	Dia. 17.4 x H. 6.85cm	Dia. 14.4-15.5cm
DLED-63(20W)	20W(40pcs x 0.5W SMD2825 LED)	1600LM(4000K)	Dia. 24.4 x H. 8.45cm	Dia. 19.5-21cm
DLED-63(24W)	24W(48pcs x 0.5W SMD2825 LED)	1920LM(4000K)	Dia. 24.4 x H. 8.45cm	Dia. 19.5-21cm



LED Down Light

- Material: Aluminum
- Voltage: 100V ~ 240V
- Color Temperature: 3000K ~ 6400K
- Finish: White



● **DLED-856(3W)**



● **DLED-856(6W)**



● **DLED-856(9W)**



● **DLED-856(12W)**

●	Lamp	Lumen	Product size
DLED-856(3W)	3W(6pcs x SMD2835 LED)	220LM(4000K)	Dia. 8.3 x H. 3.5cm
DLED-856(6W)	6W(12pcs x SMD2835 LED)	450LM(4000K)	Dia. 10.5 x H. 4cm
DLED-856(9W)	9W(18pcs x SMD2835 LED)	670LM(4000K)	Dia. 13.5 x H. 4.1cm
DLED-856(12W)	12W(24pcs x SMD2835 LED)	960LM(4000K)	Dia. 15.7 x H. 4.3cm



Driver Built-in LED Down Light-CE IP44 Version is Optional



- Material: Aluminum Middle Ring + Plastic Frame/Diffuser/Housing
- Voltage: AC 85V ~ 265V
- Color Temperature: 2700K ~ 6500K
- Finish: White



● **DLED-62**

●	Lamp	Lumen	Product size	Cut out size
●	DLED-62(3W) 3W(3pcs x SMD3030 LED)	180LM(4000K)	Dia. 10 x H. 5.8cm	Dia. 8cm
●	DLED-62(5W) 5W(5pcs x SMD3030 LED)	300LM(4000K)	Dia. 10 x H. 5.8cm	Dia. 8cm
●	DLED-62(9W) 9W(9pcs x SMD3030 LED)	540LM(4000K)	Dia. 14 x H. 7.2cm	Dia. 12cm
●	DLED-62(12W) 12W(12pcs x SMD3030 LED)	840LM(4000K)	Dia. 14 x H. 7.2cm	Dia. 12cm
●	DLED-62(15W) 15W(15pcs x SMD3030 LED)	1050LM(4000K)	Dia. 19 x H. 8.5cm	Dia. 16cm

CE Construction (with connection box as below shown)



Recessed Down Light

•Material: Zinc Alloy



● **DL-2**
MR16 LED 5W



● **DL-3**
MR16 LED 5W



● **DL-4**
MR16 LED 5W

● **DL-2G**
GU10 LED 6W

● **DL-3G**
GU10 LED 6W

● **DL-4G**
GU10 LED 6W



● **DL-5**
MR16 LED 5W



● **DL-5T**
MR16 LED 5W



● **DL-6**
MR16 LED 5W

● **DL-5G**
GU10 LED 6W

● **DL-5TG**
GU10 LED 6W

● **DL-6G**
GU10 LED 6W



● **DL-8**
MR16 LED 5W



● **DL-10**
MR16 LED 5W



● **DL-12**
MR16 LED 5W

● **DL-8G**
GU10 LED 6W

● **DL-10G**
GU10 LED 6W

● **DL-12G**
GU10 LED 6W



● **DL-14**
MR16 LED 5W



● **DL-15**
MR16 LED 5W

● **DL-14G**
GU10 LED 6W

● **DL-15G**
GU10 LED 6W



● **DL-2S**
MR11 5W LED Bulb



● **DL-3S**
MR11 5W LED Bulb



● **DL-5S**
MR11 5W LED Bulb



● **DL-12S**
MR11 5W LED Bulb

Recessed Down Light

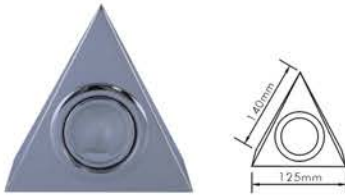

● **DL-31**

Pressed Iron
JC4 12V 3.5W LED Bulb

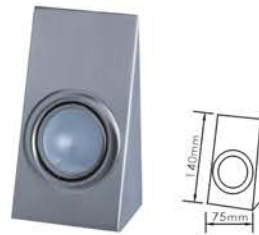

● **DL-32**

Pressed Iron
JC4 12V 3.5W LED Bulb

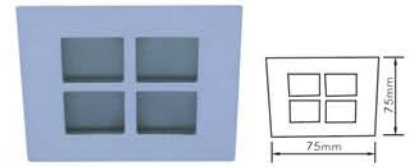

● **DL-33**

Zinc Alloy
MR16 LED 5W

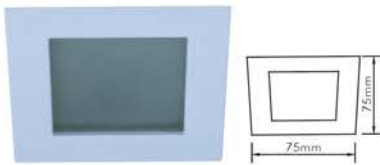

● **DL-34**

Zinc Alloy
MR16 LED 5W

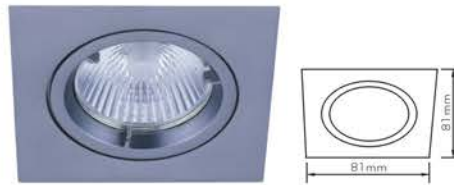

● **DL-35**

Zinc Alloy
MR16 LED 5W

● **DL-35G**

Zinc Alloy
GU10 LED 6W



● **DL-35R1**

Zinc Alloy
MR16 LED 5W

● **DL-35GR1**

Zinc Alloy
GU10 LED 6W

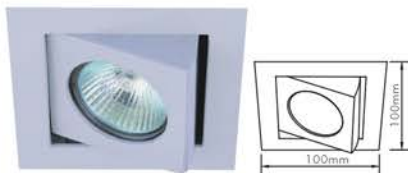

● **DL-36**

Aluminum
MR16 LED 5W



● **DL-37**

Pressed Iron
JC4 12V 3.5W LED Bulb



● **DL-38**

Pressed Iron
JC4 12V 3.5W LED Bulb



● **DL-39**

Aluminum
MR16 LED 5W



● **DL-40**

Zinc Alloy
MR16 LED 5W

● **DL-40G**

Zinc Alloy
GU10 LED 6W



● **DL-41**

Aluminum
MR16 LED 5W



● **DL-42**

Aluminum
MR16 LED 5W



● **DL-43**

Pressed Iron
JC4 12V 3.5W LED Bulb



● **DL-44**

Aluminum
MR16 LED 5W

Recessed Down Light

- Material: Pressed Iron
- Finish: P. Brass/Chrome/Black/White



● **DL-9S CH**
MR11 5W LED Bulb



● **DL-9S PB**
MR11 5W LED Bulb



● **DL-9S BK**
MR11 5W LED Bulb



● **DL-9S WH**
MR11 5W LED Bulb



● **DL-9 CH**
MR16 LED 5W GU10 LED 6W



● **DL-9 PB**
MR16 LED 5W GU10 LED 6W



● **DL-9 BK**
MR16 LED 5W GU10 LED 6W



● **DL-9 WH**
MR16 LED 5W GU10 LED 6W



● **DL-7 CH**
MR16 LED 5W GU10 LED 6W



● **DL-7 PB**
MR16 LED 5W GU10 LED 6W



● **DL-7 BK**
MR16 LED 5W GU10 LED 6W



● **DL-7 WH**
MR16 LED 5W GU10 LED 6W



● **DL-11S CH**
MR11 5W LED Bulb



● **DL-11S PB**
MR11 5W LED Bulb



● **DL-11S BK**
MR11 5W LED Bulb



● **DL-11S WH**
MR11 5W LED Bulb



● **DL-11 CH**
MR16 LED 5W GU10 LED 6W



● **DL-11 PB**
MR16 LED 5W GU10 LED 6W



● **DL-11 BK**
MR16 LED 5W GU10 LED 6W



● **DL-11 WH**
MR16 LED 5W GU10 LED 6W

Recessed Down Light

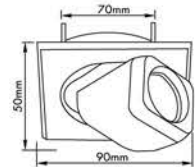

● **DL-52**

Zinc Alloy
MR11 5W LED Bulb

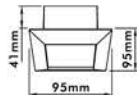

● **DL-50**

Zinc Alloy
JC4 12V 3.5W LED Bulb

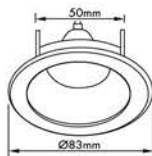

● **DL-53**

Zinc Alloy
MR16 LED 5W

● **DL-53G**

Zinc Alloy
GU10 LED 6W

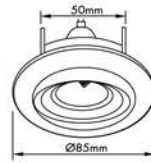

● **DL-54**

Aluminum
MR16 LED 5W

● **DL-54G**

Aluminum
GU10 LED 6W

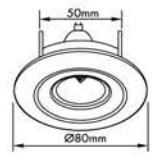

● **DL-55**

Aluminum
MR16 LED 5W

● **DL-55G**

Aluminum
GU10 LED 6W

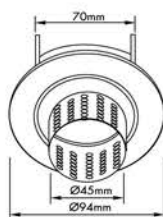

● **DL-56**

Zinc Alloy
MR16 LED 5W

● **DL-56G**

Zinc Alloy
GU10 LED 6W



● **DL-57**

Zinc Alloy
MR16 LED 5W

● **DL-57G**

Zinc Alloy
GU10 LED 6W

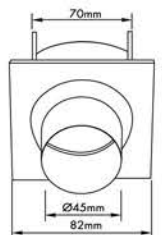

● **DL-58**

Zinc Alloy
MR16 LED 5W

● **DL-58G**

Zinc Alloy
GU10 LED 6W

Security Light

Home Resource 2017 Collection

LED Security Light

- Material: ABS Body + PC Diffuser
- Voltage: 110V or 240V
- Color Temperature: 2700K ~ 6500K
- Lamp: 28.8W (144 x 0.2W SMD2835 LED)
- Lumen: 1500LM (6500LK)
- Motion Sensor: 10M, 120°, 30 Secs
- Color: Gray

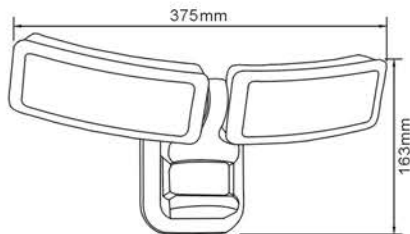

● **ELED-307S-2**



Battery Operated LED Security Light

- Material: ABS Body + PC Diffuser + Aluminum Reflector
- Battery: 4 x C Excl.
- Sensor: 8M, 100° , 5Secs~7Mins, 20~10000Lux
- Color: Black/White
- IP44



CE EMC

✓ RoHS

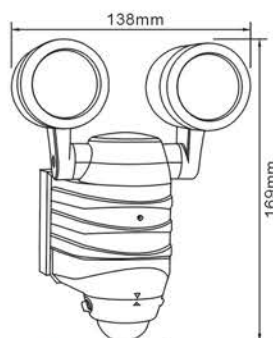

TIME



LUX

● **ELED-304S-2**

Lamp: 10W (2 x 5W LED)
Lumen: 450LM (6000K)
Battery Working Time: 5H

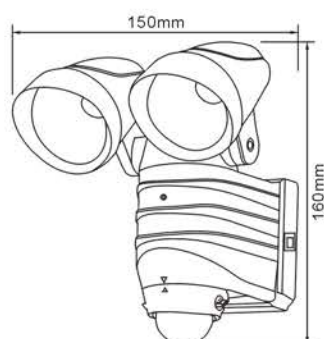

● **ELED-303S-2**

Lamp: 2W (2 x 1W LED)
Lumen: 100LM (6000K)
Battery Working Time: 12H



LED Battery Operated Security Light

- Material: ABS
- Lamp: 0.72W (12 x 0.06W Φ 5 LED)
- Lumen: 110LM (12,000K ~ 13,000K)
- Battery: 3 x AA (Excl.)
- Motion Sensor: 7~8M, 120°, 30S/60S/90S
- Switch: On/Off/Auto
- Color: Black/White

CE EMC

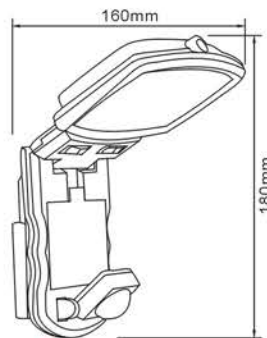

● **BO-LED018**



90 degree



Back side

LED Battery Operated Security Light

SGS **CE**

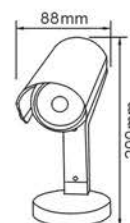

● **ELED-B350**

Realistic Design. Like a Real Camera

Material: PS + ABS

Lamp: 0.36W (6 x 0.06W Φ 5 LED)

Battery Working Time: 17H (4 x AA Excl.)

Motion Sensor: 110° (Horizontal), 90° (Vertical), 28S \pm 3S, 3~5M

Color: Silver / Black

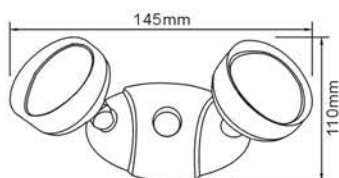

● **ELED-B305S-2**

Material: ABS + PC

Lamp: 0.4W (2 x 0.2W SMD2835 LED)

Battery Working Time: 12H (3 x AA Excl.)

Slide Switch: Off/Auto

Motion Sensor: 110° (Horizontal), 90° (Vertical), 40S \pm 3S, 3~5M

Color: Silver / Black



Battery (3 x AA Excl.)



Slide Switch: ON(Auto)/OFF

LED Solar Security Light

- Material: ABS + PS
- Lamp: 3W (1 x 3W high power LED)
- Lumen: 85LM (6500K)
- Motion Sensor: 110° (Horizontal), 90° (Vertical), 25S±3S, 3~5M
- With 1pc 3.7V 1000mAh Rechargeable Lithium Battery
- With Mono-crystalline Silicon Solar Panel
- Switch: Off-Auto
- Color: Black/White

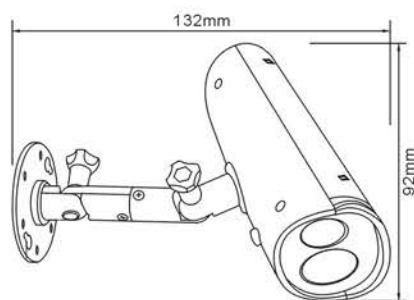

● SOL-009



High Bay Light

Home Resource 2017 Collection

LED High Bay Light-UFO

- Material: Aluminum Body & Reflector + PC Diffuser
- Voltage: 90V ~ 305V
- Finish: Black Body + Natural Alu. Reflector
- IP65

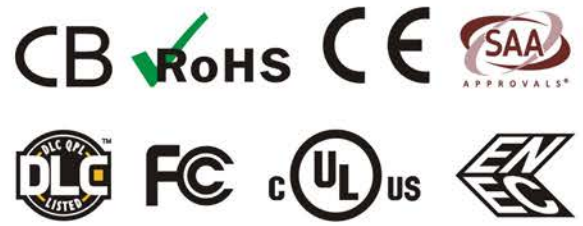

● HBLED-28-150

Lamp: 150W (182 x Philip SMD3030 LED)
Meanwell Driver
Lumen: 16800LM (2700K ~ 3500K)
Beam Angle: 125°



HBLED-28-150 with Beam Angle 120° reflector

Optional Reflector



Beam Angle 60°



Beam Angle 90°



Beam Angle 120°



● HBLED-28-200

Lamp: 200W (238 x Philip SMD3030 LED)
Meanwell Driver
Lumen: 21800LM (2700K ~ 3500K)
Beam Angle: 125°



HBLED-28-200 with Beam Angle 120° reflector

LED High Bay

- Material: Aluminum
- Finish: Silver
- Input Voltage: 220V
- Luminous Flux: 90lm/W
- Color Temperature: 2700~7000K
- IP20



● **HBLED-11**

Power: 100W COB LED
Product size: Ø430mm



● **HBLED-12**

Power: 50W COB LED
Product size: Ø450mm



● **HBLED-14**

Power: 100W COB LED
Product size: Ø510mm

Air Monitor Light

Home Resource 2017 Collection

Air Monitor LED Sensor Night Light

- Material: PC
- Voltage: AC 100V ~ 240V
- Color: White
- Air detector working based on VOC (Volatile Organic Compounds)



(PIR + CDS Sensor Version)

Lamp: 1.2W (5 x 0.2W SMD2835 LED + 1 x 0.2W SMD5050 RGB LED)
 Lumen: 5LM
 Switch: Auto / Off / On
 PIR + CDS Sensor: PIR (2.5M, 20S, Horizontal 100° , Vertical 50°) / CDS (Working when < 10Lux)

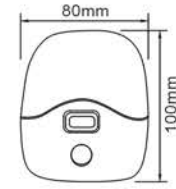

● **BO-LED024S**

(CDS Sensor Version)

Lamp: 0.7W (5 x 0.1W SMD3014 LED + 1 x 0.2W SMD5050 RGB LED)
 Lumen: 13LM
 With 2 USB Ports
 CDS Sensor: Working when < 10Lux



● **BO-LED024SC**

• **Air Quality Index (for reference only)**

Can detect the noxious gas (including Alcohol, Ammonia, Benzene, Cigarette smoke, CO, Hydrogen, Methanol ... and so on.)



Green Light:
Good Air Quality



Yellow Light:
Moderate Air Quality



Red Light:
Bad Air Quality



Air Quality Index	Density of Harmful Gas	Correspondent color of indicator light	Potential Health Effects and Action to take
Level 1	TC<0.5PPM	Green	Air quality is satisfactory
Level 2	0.5PPM<TC<1.5PPM	Yellow	Medium-polluted air is detected. Suggest to open the window to get fresh air. Weak persons not to exercise vigorously in this area.
Level 4	1.5PPM<TC	Red	Heavily-polluted air is detected. Suggest to open the window or air purifier. Children, Elders, Infants and Pregnane not stay at this area for a long time.



UL Plug



VDE Plug



SAA Plug



BS Plug



PSE Plug

Air Monitor LED Sensor Night Light

- Material: PC
- Lamp: 0.4W (2 x 0.2W SMD5050 RGB LED)
- Voltage: AC 100V ~ 240V
- Color: White
- Air detector working based on VOC (Volatile Organic Compounds)

CE EMC  RoHS

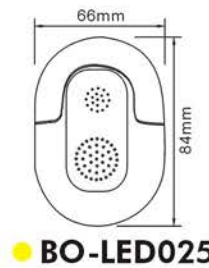

Green Light:
Good Air Quality



Yellow Light:
Moderate Air Quality



Red Light:
Bad Air Quality

• Air Quality Index (for reference only)

Can detect the noxious gas (including Alcohol, Ammonia, Benzene, Cigarette smoke, CO, Hydrogen, Methanol ... and so on.)

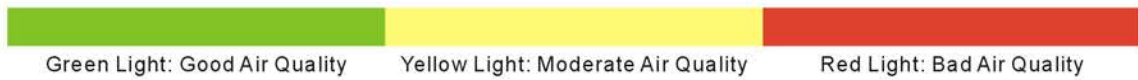

Air Quality Index	Density of Harmful Gas	Correspondent color of indicator light	Potential Health Effects and Action to take
Level 1	TC<0.5PPM	Green	Air quality is satisfactory
Level 2	0.5PPM<TC<1.5PPM	Yellow	Medium-polluted air is detected. Suggest to open the window to get fresh air. Weak persons not to exercise vigorously in this area.
Level 4	1.5PPM<TC	Red	Heavily-polluted air is detected. Suggest to open the window or air purifier. Children, Elders, Infants and Pregnene not stay at this area for a long time.



UL Plug



VDE Plug



SAA Plug



BS Plug



PSE Plug

Sensor & Sensor Socket

Home Resource 2017 Collection

Infrared Motion Detector PIR Sensor

- Material: Plastic + Metal
- Power Source: 110~130V/AC OR 220~240V/AC
- Work Temperature: -20°C ~ +40°C
- Available Color: Black / White
- IP20

CE  RoHS EMC











● HR-S16A



● HR-S17





ITEM	HR-S16A	HR-S17
Detection Distance (22~24°C)	6M MAX	6M MAX
Detection Angle (Max)	360°	360°
Total Max. Rated Load	800W (110~130V/AC)  1200W (220~240V/AC)  200W (110~130V/AC)  300W (220~240V/AC) 	300W (110~130V/AC)  500W (220~240V/AC)  100W (110~130V/AC)  150W (220~240V/AC) 
Installation Height	1.5~3.5M	1.5~3.5M
Time Delay (adjustable)	10±3Sec~8±2Min	5Sec~10±2Min
Ambient Light (adjustable)	<10~2000Lux	<10~2000Lux

Infrared Motion Detector PIR Sensor(Outdoor Use)

- Material: Plastic + Metal
- Power Source: 110~130V/AC OR 220~240V/AC
- Work Temperature: -20°C ~ +40°C
- Available Color: Black / White
- IP44

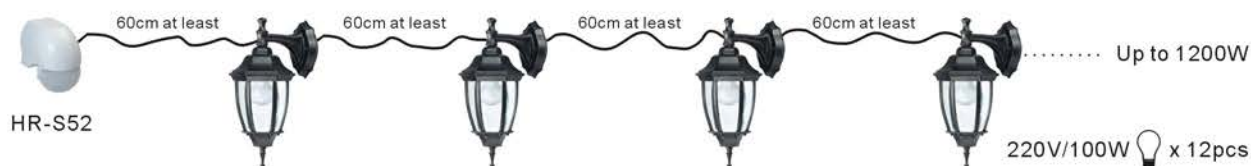
CE  RoHS EMC





ITEM	HR-S51	HR-S52
Detection Distance (22~24°C)	12M MAX	12M MAX
Detection Angle (Max)	180°	180°
Total Max. Rated Load	800W (110~130V/AC)  1200W (220~240V/AC)	200W (110~130V/AC)  300W (220~240V/AC)
Installation Height	2~4.5M	1.8~2.5M
Time Delay (adjustable)	10±3Sec~8±2Min	10±3Sec~7±2Min
Ambient Light (adjustable)	<10~2000Lux	<3~2000Lux
Remark	With indicator to show it works normally	

Motion Detector(Sensor Socket)

- Material: Plastic + Metal
- Power Source: 220~240V/AC only
- Adaptable Plug: EU plug (German type or French type)
- Work Temperature: -20°C ~ +40°C
- Available Color: Black / White
- IP20

CE  RoHS EMC

ITEM	HR-S73
Detection Distance (22~24°C)	9M MAX (adjustable)
Detection Angle (Max)	120°
Max. Rated Load	1200W (220~240V/AC) 
	300W (220~240V/AC) 
Installation Height	1~1.8M
Time Delay (adjustable)	10±3Sec~7±2Min
Ambient Light (adjustable)	<3~2000Lux
Remark	AUTO / OFF / ON

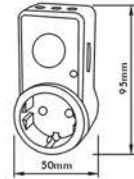
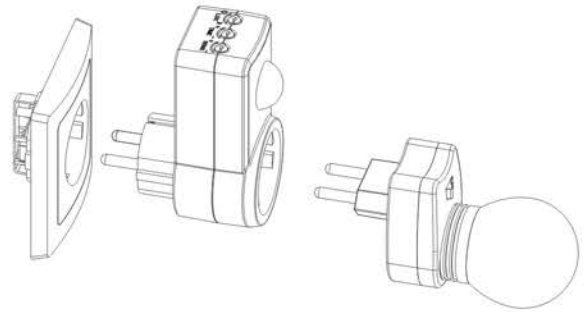

● HR-S73



(French socket)



(German socket)

Motion Detector(PIR Sensor)

- Rated Load: 1200W(220-240V/AC) or 800W(110-130V/AC)
- Power Source: 220-240V/AC or 110-130V/AC
- Ambient Temperature: -20 - +40°C



● HR-S9



● HR-S10



● HR-S11



● HR-S12



● HR-S13



● HR-S15

ITEM	HR-S9	HR-S10	HR-S11	HR-S12	HR-S13	HR-S15
Detection Distance	12m	12m	9m	12m	2-12m	12m
Detection Range (Max)	360°	360°	140°	180°	180°	180°
Installation Height	1.5-3.5m	1.5-3.5m	1-1.6m	0.5±3.5m	1.8-2.5m	0.5±3.5m
Time Delay	5Sec.-9Min	5Sec.-9Min	5Sec.-9Min	8Sec.-8Min	5Sec.-8Min	8Sec.-8Min
IP	20	20	20	44	44	44

Motion Detector(PIR Sensor)

- Power Source: 110-130V/AC, 220-240V/AC
- Working Temperature: -20~+40°C



● HR-S1



● HR-S2



● HR-S3



● HR-S4



● HR-S5



● HR-S6



● HR-S8

Item	S1	S2	S3	S4	S5	S6	S8
Detection Distance	10±2M	10±2M	12±2M	10±2M	10±2M	19M	13M
Detection Range(Max)	360°	140°	180°	360°	180°	110°	180°
Rated Load	1000W	500W	1000W	1000W	500W	1500W	1000W
Installation Height	2~4.5M	0.4~1.8M	0.5~3.5M	2~4.5M	2~4.5M	2~4.5M	2~4.5M
IP	20	20	44	44	44	44	44
Sensitivity(Sound Control)	-	30db~90db	-	-	-	-	-

ITEM	HR-S14
Detection Distance	9m
Detection Range (Max)	180°
Rated Load	200W(220-240V/AC) or 100W(110-130V/AC)
Installation Height	1-1.6m
Time Delay	5Sec.-9Min
	20



● HR-S14

Bulb & Tube

Home Resource 2017 Collection

LED Filament Bulb

- Material: Glass
- Color Temperature: 2800K ~ 6400K
- Color: Transparent



● ● E27G125FLED-6WF2-AM4G



● ● E27G125FLED-6WF2-TT4G



● ● E27T64FLED-6WF3-TT4G



● ● E27T64FLED-6WF3-AM4G



● ● E27A60FLED-6WF1-TT4G

● ● E27 LED Bulb (220V ~ 240V)

Item No.	Lampbase	Lamp	Lumen	Product size
E27G125FLED-6WF2-AM4G	E27	6W(Filament LED)	500LM(4000K)	Dia. 12 x H. 18cm
E27G125FLED-6WF2-TT4G	E27	6W(Filament LED)	500LM(4000K)	Dia. 12 x H. 18cm
E27T64FLED-6WF3-AM4G	E27	6W(Filament LED)	500LM(4000K)	Dia. 6.5 x H. 14.5cm
E27T64FLED-6WF3-TT4G	E27	6W(Filament LED)	500LM(4000K)	Dia. 6.5 x H. 14.5cm
E27A60FLED-6WF1-TT4G	E27	6W(Filament LED)	800LM(2700K)	Dia. 6 x H. 10.8cm

UFO LED Bulb

- Material: PC + Aluminum
- Color Temperature: 2800K ~ 6400K
- Color: White / Gold



● **E27UFOLED-18WG1**



● **E27UFOLED-24WG1**



● **E27UFOLED-36WG1**

● **E27 LED Bulb (220V ~ 240V)**

Item No.	Lampbase	Lamp	Lumen	Product size
E27UFOLED-18WG1	E27	18W(48x0.5W SMD2835 LED)	1600LM(4000K)	Dia. 12.5 x H. 10cm
E27UFOLED-24WG1	E27	24W(72x0.5W SMD2835 LED)	2300LM(4000K)	Dia. 15.5 x H. 10cm
E27UFOLED-36WG1	E27	36W(120x0.5W SMD2835 LED)	3400LM(4000K)	Dia. 18.5 x H. 10cm

LED Bulb

- Material: PC + Aluminum
- Color Temperature: 2800K ~ 6400K
- Color: White



● E27 A60 LED Bulb (220V ~ 240V)

Item No.	Lampbase	Lamp	Lumen	Product size
E27A60LED-5WC2	E27	5W(5x1W SMD2835 LED)	500LM(4000K)	Dia. 6 x H. 11cm
E27A60LED-7WC2	E27	7W(7x1W SMD2835 LED)	650LM(4000K)	Dia. 6 x H. 11cm
E27A60LED-9WC2	E27	9W(9x1W SMD2835 LED)	850LM(4000K)	Dia. 6 x H. 11cm
E27A60LED-12WC2	E27	12W(12x1W SMD2835 LED)	1055LM(4000K)	Dia. 6 x H. 12cm



● E14 C35 LED Bulb (220V ~ 240V)

Item No.	Lampbase	Lamp	Lumen	Product size
E14C35LED-3WA5	E14	3W(3x1W SMD2835 LED)	250LM(4000K)	Dia. 3.5 x H. 10.6cm / H. 12.6cm
E14C35LED-4WA5	E14	4W(4x1W SMD2835 LED)	350LM(4000K)	
E14C35LED-5WA5	E14	5W(5x1W SMD2835 LED)	500LM(4000K)	
E14C35LED-6WA5	E14	6W(6x1W SMD2835 LED)	580LM(4000K)	
E14C35LED-7WA5	E14	7W(7x1W SMD2835 LED)	650LM(4000K)	



● E27PAR20LED-9WB2



● E27PAR30LED-12WB2



● E27PAR38LED-18WB2

● E27 PAR20/PAR30/PAR38 LED Bulb (220V ~ 240V)

Item No.	Lampbase	Lamp	Lumen	Product size
E27PAR20LED-9WB2	E27	9W(9x1W SMD2835 LED)	800LM(4000K)	Dia. 6.4 x H. 8.1cm
E27PAR30LED-12WB2	E27	12W(12x1W SMD2835 LED)	1000LM(4000K)	Dia. 9.6 x H. 9cm
E27PAR38LED-18WB2	E27	18W(18x1W SMD2835 LED)	1500LM(4000K)	Dia. 12.9 x H. 13cm

LED Bulb

- Material: PC + Aluminum
- Color Temperature: 2800K ~ 6400K
- Color: White



● GU10 LED Bulb (220V ~ 240V)

Item No.	Lampbase	Lamp	Lumen	Product size
GU10LED-3WB1	GU10	3W(3x1W SMD2835 LED)	250LM(4000K)	Dia. 5 x H. 5.5cm
GU10LED-4WB1	GU10	4W(4x1W SMD2835 LED)	350LM(4000K)	
GU10LED-5WB1	GU10	5W(5x1W SMD2835 LED)	500LM(4000K)	
GU10LED-6WB1	GU10	6W(6x1W SMD2835 LED)	580LM(4000K)	
GU10LED-7WB1	GU10	7W(7x1W SMD2835 LED)	650LM(4000K)	

● MR16 LED Bulb (AC/DC 12V)

Item No.	Lampbase	Lamp	Lumen	Product size
MR16LED-3WB1	MR16	3W(3x1W SMD2835 LED)	250LM(4000K)	Dia. 5 x H. 5cm
MR16LED-4WB1	MR16	4W(4x1W SMD2835 LED)	350LM(4000K)	
MR16LED-5WB1	MR16	5W(5x1W SMD2835 LED)	500LM(4000K)	
MR16LED-6WB1	MR16	6W(6x1W SMD2835 LED)	580LM(4000K)	
MR16LED-7WB1	MR16	7W(7x1W SMD2835 LED)	650LM(4000K)	



● **G9LED-2WB5**



● **G9LED-3WB6**

● G9 LED Bulb (220V ~ 240V)

Item No.	Lampbase	Lamp	Lumen	Product size
G9LED-2WB5	G9	2W(2x1W SMD2835 LED)	160LM(4000K)	Dia. 1.8 x H.5.8cm
G9LED-3WB6	G9	3W(3x1W SMD2835 LED)	200LM(4000K)	Dia. 1.8 x H.6cm



● G4 LED Bulb (AC/DC 12V)

Item No.	Lampbase	Lamp	Lumen	Product size
G4LED-3WB6	G4	3W(3x1W SMD2835 LED)	200LM(4000K)	Dia. 1.8 x H. 5.5cm

LED Bulb

- Material: PC + Aluminum
- Color Temperature: 2800K ~ 6400K
- Color: White for LED Bulb / Chrome for LED Filament Bulb



- E14R50FLED-2W
- E14R50FLED-4W

- E27R63FLED-2W
- E27R63FLED-4W

- E27R80FLED-4W
- E27R80FLED-6W

● E14/E27 R50/R63/R80 LED Filament Bulb (220V ~ 240V)

Item No.	Lampbase	Lamp	Lumen	Product size
E14R50FLED-2W	E14	2W(2x1W SMD2835 LED)	230LM(4000K)	Dia. 5 x H. 8.6cm
E14R50FLED-4W	E14	4W(4x1W SMD2835 LED)	430LM(4000K)	
E27R63FLED-2W	E27	2W(2x1W SMD2835 LED)	230LM(4000K)	Dia. 6.3 x H. 10.6cm
E27R63FLED-4W	E27	4W(4x1W SMD2835 LED)	430LM(4000K)	
E27R80FLED-4W	E27	4W(4x1W SMD2835 LED)	430LM(4000K)	Dia. 8 x H. 11cm
E27R80FLED-6W	E27	6W(6x1W SMD2835 LED)	630LM(4000K)	



- E14R50LED-6W

- E27R63LED-6W
- E27R63LED-8W

- E27R80LED-8W
- E27R80LED-10W
- E27R80LED-12W

● E14/E27 R50/R63/R80 LED Bulb (220V ~ 240V)

Item No.	Lampbase	Lamp	Lumen	Product size
E14R50LED-6W	E14	6W(6x1W SMD2835 LED)	480LM(4000K)	Dia. 5 x H. 8.6cm
E27R63LED-6W	E27	6W(6x1W SMD2835 LED)	480LM(4000K)	Dia. 6.3 x H. 10.5cm
E27R63LED-8W	E27	8W(8x1W SMD2835 LED)	650LM(4000K)	
E27R80LED-8W	E27	8W(8x1W SMD2835 LED)	650LM(4000K)	Dia. 8 x H. 11cm
E27R80LED-10W	E27	10W(10x1W SMD2835 LED)	850LM(4000K)	
E27R80LED-12W	E27	12W(12x1W SMD2835 LED)	1055LM(4000K)	

R7S LED Bulb

- Material: PC + Aluminum
- Voltage: 110V ~ 260V
- Finish: White

✓ **RoHS ErP CE**



● **J78L-5WA1**

● **J118L-10WA1**

● **J189L-15WA1**

●	Lamp	Lumen	Product size
J78L-5WA1	5W(36pcs x SMD2835 LED)	400LM(4000K)	L. 7.8 x W. 2.2 x H. 2.2cm
J118L-10WA1	10W(72pcs x SMD2835 LED)	800LM(4000K)	L. 11.8 x W. 2.2 x H. 2.2cm
J189L-15WA1	15W(132pcs x SMD2835 LED)	1200LM(4000K)	L. 18.9 x W. 2.2 x H. 2.2cm

LED Bulb

• Voltage: 220V ~ 240V

● E14 LED Bulb

Item No.	Material	Lampbase	Lamp	Lumen	Product size
E14LED-3WH1	Silicon	E14	3W(64pcs x SMD3014 LED)	210-230LM(4000K)	Dia. 1.8 x H. 5.3cm
E14LED-5WH1	Silicon	E14	5W(72pcs x SMD2835 LED)	360-380LM(4000K)	Dia. 1.8 x H. 6.5cm



● E14LED-3WH1



● E14LED-5WH1

● G4 AC Type LED Bulb

Item No.	Material	Lampbase	Lamp	Lumen	Product size
G4ACLED-5WH2	Ceramic+PC	G4	5W(51pcs x SMD2835 LED)	350-380LM(4000K)	Dia. 1.6 x H. 4.5cm
G4ACLED-1WH1	Silicon	G4	1.5W(24pcs x SMD3014 LED)	100-110LM(4000K)	Dia. 1 x H. 3.6cm
G4ACLED-3WH1	Silicon	G4	3W(64pcs x SMD3014 LED)	210-230LM(4000K)	Dia. 1.5 x H. 4.3cm



● G4ACLED-5WH2



● G4ACLED-1WH1



● G4ACLED-3WH1

● G9 LED Bulb

Item No.	Material	Lampbase	Lamp	Lumen	Product size
G9LED-3WI1	PC	G9	3W(14pcs x SMD2835 LED)	250-280LM(4000K)	Dia. 1.6 x H. 4.8cm
G9LED-5WI1	PC	G9	5W(22pcs x SMD2835 LED)	450-480LM(4000K)	Dia. 1.6 x H. 5.5cm
G9FLED-4WF4	Ceramic+PC	G9	4W(Filament LED)	350-380LM(4000K)	Dia. 1.6 x H. 5.3cm
G9LED-5WH2	Ceramic+PC	G9	5W(51pcs x SMD2835 LED)	350-380LM(4000K)	Dia. 1.6 x H. 5cm
G9LED-7WH2	Ceramic+PC	G9	7W(75pcs x SMD2835 LED)	500-550LM(4000K)	Dia. 1.8 x H. 6.8cm
G9LED-3WH1	Silicon	G9	3W(40pcs x SMD2835 LED)	210-230LM(4000K)	Dia. 1.7 x H. 5cm
G9LED-4WH1	Silicon	G9	4W(72pcs x SMD3014 LED)	310-330LM(4000K)	Dia. 1.7 x H. 6cm



● G9LED-4WH1



● G9LED-3WI1



● G9LED-5WI1



● G9FLED-4WF4



● G9LED-5WH2



● G9LED-7WH2



● G9LED-3WH1

T8 LED Tube

- Material: Glass
- Voltage: 165V ~ 265V
- Color Temperature: 3000K ~ 6500K
- Finish: White

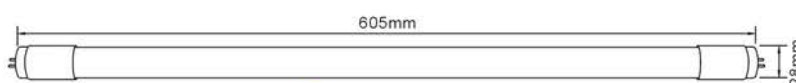

● **T8LD-G60**

●	Lamp	Lumen	Product size
T8LD-G60	9W(48pcs x SMD2835 LED)	1050LM(4000K)	L. 60.5 x W. 2.8 x H. 2.8cm
T8LD-G90	14W(72pcs x SMD2835 LED)	1650LM(4000K)	L. 91.5 x W. 2.8 x H. 2.8cm
T8LD-G12	18W(96pcs x SMD2835 LED)	2150LM(4000K)	L. 121.5 x W. 2.8 x H. 2.8cm
T8LD-G15	24W(120pcs x SMD2835 LED)	2800LM(4000K)	L. 151.5 x W. 2.8 x H. 2.8cm



Supply Partner

We are not only playing the role as a manufacturer but also can implement as a supply partner on your behalf which covers following functions:.

- Quality control ie quality assurance & conduct inspection.
- Shipping control ie consolidation of goods & shipment arrangement.
- Payment release
- Buying trip arrangement

We involve a comprehensive product range covering home lighting; commercial lighting, outdoor lightings, bulbs & tube lights.

if you are in consideration of having some one to act as your supply partner for above function , please don't hesitate to contact Home Resource for further discussion.



■ Service team



■ Inspection & Testing



■ Shipping & Financial

Sales Representative Wanted



R&D Personnel Wanted



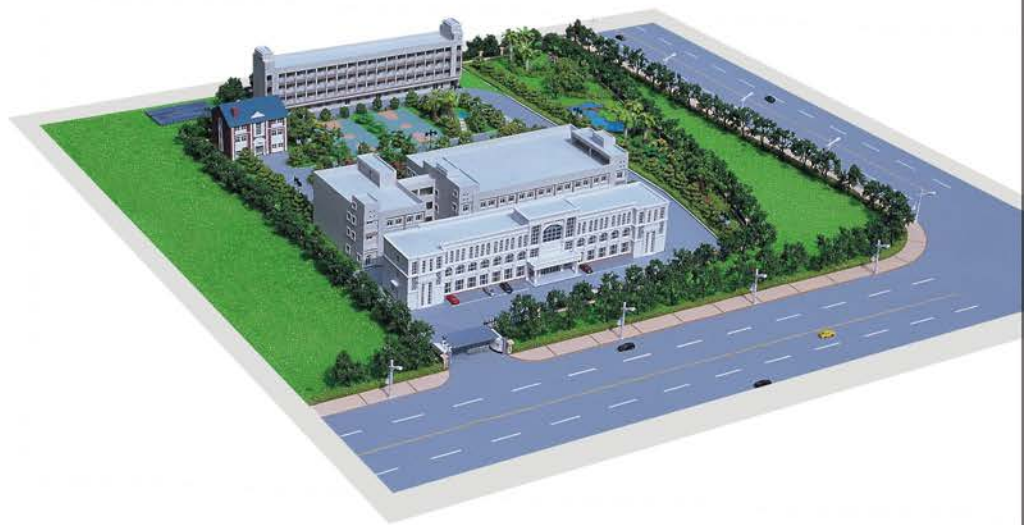

China New Factory (Zhongshan City, Guangdong Province)

Home Resource's products are designed and manufactured by its own factory (Green Resource) sited in Zhongshan, China.





Home Resource Ind. Co., Ltd.

The 20th Home Resource Prize Golf Invitation Tournament

To be held at Agile Golf & Country Club, ZhongShan, China

Expect your Participation



■ **Home Resource Golf Team**

Welcome Your Participation for a Friendly Golf Competition



Please call reservation line: +86-760-2369-9888 ext.803 Cynthia Cheng



Manufacturer • Buying Agent • Inspection Agent



Home Resource Ind. Co., Ltd.

4F, No. 69-5, Sec. 2, Chung Cheng East Rd., Tanshui District 25170, New Taipei City, Taiwan

Tel : 886-2-2809-1212 (Rep. 12Lines) Fax : 886-2-2808-1565

E-mail : hr@homerresource.com.tw www.homerresource.com.tw

Factory : Green Resource Illumination Co., Ltd. (ZhongShan)

No. 8, Yanjiang W. 1st Rd., Keji Ave., Torch Development Zone, Zhongshan City,
Guangdong, China

廣東省中山市火炬開發區科技大道沿江西一路8號



ISO 9001