

2019 Hong Kong  
International Lighting Fair(Autumn)

# 2019 NEW EDITION PART 3

LED PLANT GROW LIGHT · SMART LIGHTING  
NOVELTY LIGHT · INTERIOR LIGHT



HOME RESOURCE IND. CO., LTD.  
Home Resource LEDS The World



## Home Resource History Timelines

- 1988 Established Home Resource Ind. Co., Ltd in Taiwan
- 1992 Established Home Resource in Shanghai
- 1995
  - HR being the 1st Taiwanese company in receipt of SEMKO, NEMKO, and DEMKO Certificates
  - Established Home Resource in Shunde for Inspection, sourcing, consolidation to Customer service
- 1996 Received Excellent Quality Award, Spain in 1996
- 1997 Established Home Resource Golf Team
- 1998 Established Charitable Menorial Foundation of Caring for the elderly
- 1999
  - Established Home Resource in Qinxi, Dongguan (Guangdong) in 1999
  - Awarded the ISO 9001:2000 certification in 1999
- 2003
  - Awarded from TUVPS as one of the TOP 5 Golden Clients in Asia in 2003
  - Founded the scholarships in Longung Elementary School in Taichung city, Taiwan in 2003
- 2004 President Sam Chen was being the Chairman of Taiwan Lighting Association (2004-2007).
- 2005
  - Received National Quality Award in Taiwan in 2005
  - Moving from Shanghai to Ningbo - The first Taiwanese lighting company in Ningbo
- 2006 Acquired 26,000 square meters land in Zhong Shan City, Guangdong
- 2007 Awarded as one of the best "ISO 9001:2000" companies listed as members of KEMA organization
- 2008
  - Red Dot Design Award, 2008, Germany
  - Good Design Product, 2008, Taiwan
- 2010
  - Established New Factory in Zhong Shan (Guangdong)
  - Established the Research & Development center
- 2013 Awarded the BSCI certification in 2013
- 2015 Received National Excellent Lighting Quality Award in Japan in 2015
- 2017 Received The Best Innovation Award of Taiwan Lighting Association in 2017





## OUR VISION

**To Illuminate Every Part of the World**

## OUR MISSION

- To be the leading lighting company in Taiwan and China
- To be the best at what customers value most
- To exceed customers expectation
- Treat staffs & customers & substructures as partnership
- Enjoy work as part of life

## OUR CORE COMPETENCE

- Integrity
- Innovation
- Profession
- Passion
- Efficiency
- Responsibility
- Teamwork



## **China Factory - 26,000m<sup>2</sup> (Zhongshan City, Guangdong Province)**

Home Resource's products are designed and manufactured by its own factory (Green Resource) Sited in Zhongshan, China.





## President's Message

### Sam Chen Ph. D

- Chairman of TLFEA (2004-2007)  
TLFEA: Taiwan Lighting Fixture Export Association
- Director of CEECA and LABC  
CEECA: The Central, Eastern Europe and CIS Association  
LABC: Latin American Business Council
- Vice Chairman of Taiwan Investors Association in Zhongshan
-  Rotary Member

Since its establishment in 1988, Home Resource Ind. Co., Ltd. has been dedicated to production and development of lighting products for three decades.

We would like to take this opportunity to express our sincere appreciation for your fully supports and concerns over the past 31 years.

With years of efforts on upgrading production capability and capacity, Home Resource has grown into a consummate manufacturer of lightings on OEM and ODM basis. Globally reputed R&D talent has also helped Home Resource to enhance popularity and recognition of its own-brand products in recent years.

In addition to existing branches, Home Resource has opened a constructed plant of 26,000 square meters in China (Zhong Shan City, Guangdong Province), which employs advanced production equipment to assure even shorter delivery and more considerate services for clients than before.

We strive for success not only in having determination and courage, but also developing innovative products and marketing intelligence base on our core competence: innovation, efficiency, integrity and passion. Home Resource will definitely get hold of past success to carry on growing continuously in the lighting territory now and then. Let's witness the brand new, prosperous Home Resource to achieve an even higher peak of success in the coming future.

---

**David Chen**  
General Manager



Home Resource was established in 1988. Since then, the company has developed into one of the most professional lighting manufactures in Taiwan and Mainland China.

Home Resource/Green Resource would like to express our sincere thanks to all customers, parts sub-contractors and every one of our employees. It is their continuing support and hard work that has allowed Home Resource/Green Resource to grow as rapidly as they have been able to. HR&GR will continue to make even greater efforts in the future.

Other than a self-support manufacturer, through a presence in Ningbo and Zhongshan and 50 employees, Home Resource also operates a sourcing network of two offices in China.

We strive to attain a position of long-term, sustainable pre-eminence in the lighting field "lighting up" both our customers and ourselves.

We look forward to working with you all continuously to create a brilliant future.

# HOME RESOURCE

has received the following awards:

## Design Awards:



■ Good Design Product of Taiwan



■ Red Dot Award of Germany



L: Sam Chen  
(President of Home Resource Co.)

R: Alfred Albrecht, TUVPS  
(GS Testing & Certification)

- Awarded from TUVPS as one of the Top 5 golden clients in Asia (2003)



L: Sam Chen  
(President of Home Resource Co.)

R: P.K. Chiang  
(Minister of Economic Department Taiwan)

- Being as Chairman of Taiwan Lighting Association in 2004



L: Jack Chen, Former President of HR/GR  
R: Representative of Senior Group

- Award from Senior Group  
Towards Annual Charity Donation



- David Chen, the general manager of Home Resource, received 2008 innovation award for mushroom lamp in Frankfurt fair.

➤ **Safety Approval:**  
CE, GS, CUL, ETL



GS Certificate

CUL, ETL Certificate



CE Certificate

➤ **More than 60 patents...**





# Index

## LED Plant Grow Light



• PNLED-137  
Page01



• PNLED-140  
Page01



• PNLED-142  
Page02-03



• PNLED-142WLK  
Page02-03



• PNLED-142HG  
Page02-03



• PNLED-150A  
Page04-05



• PNLED-150WLK  
Page04-05



• PNLED-150HG  
Page04-05



• PNLED-144-2  
Page06-07



• PNLED-142-2  
Page06-07



• PNLED-150-2  
Page06-07



• PNLED-148  
Page08



• PNLED-149  
Page09



• PNLED-18SP  
Page10



• PNLED-142SP  
Page11



• PNLED-147  
Page12

## LED Smart Lighting



• TLED-121B  
Page14



• TLED-122B  
Page15



• TLED-218U  
Page16



• TLED-120  
Page17



• WLED-225W  
Page18



• WLED-226W  
Page19



• FLED-513W  
Page20



• FLED-514W  
Page21



• ELED-395WI  
Page22



• GPLED-395W  
Page22

# Index

---

## LED Novelty Light



• ETLED-53B  
Page24-25



• ETLED-53C  
Page24-25



• ETLED-53D  
Page24-25



• ETLED-53E  
Page24-25



• ETLED-181  
Page26



• ETLED-201A  
Page27



• ETLED-201B  
Page27



• NLED-040  
Page28



• KLED-61A  
Page29



• MRLED-97  
Page30

## LED Desk Lamp



• TLED-113  
Page32



• TLED-218U  
Page33



• TLED-120  
Page34-35



• TLED-121B  
Page34-35



• TLED-122B  
Page34-35



• TLED-163C  
Page36



• TLK-163C  
Page36



• TLED-164C  
Page37



• TLK-164C  
Page37



• TCLED-221  
Page38-39



• TCLED-222  
Page38-39



• TCLED-224  
Page38-39

LED Plant Grow Light

Hot Selling

# LED PLANT GROW Light



Material: ABS Body + Plastic Plate

Lamp: 2.5W(Red LED + Blue LED + SMD2835 White 4000K LED)

2 Switches on Base

Switch for PLANT: Red Light and Blue Light

(If the light is not turned off, it will automatically shut down after 12H)

Switch for LAMP: White Light

With 1.2m USB Cable

Color: White / Black

Glass Bucket / Tripod are Optional

IP20



● PNLED-140 (Halo)

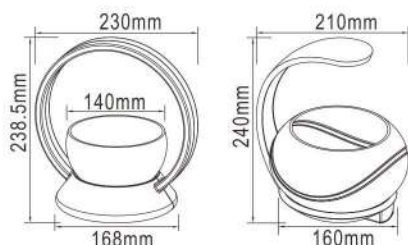

● PNLED-137 (Swan)

## Tall:

With the essential Red+Blue spectrums, stems will grow taller, and leaves will grow stronger by using it 8 hours a day.

## Healthy:

Whatever the weather, plants always receive the lights consistently which makes them grow healthier.

## Beautiful:

Switching to general lighting mode, it makes plants prettier and makes surrounding more harmonious.

Hot Selling

# LED Plant Grow Light-ALFA



Material: Iron Body + ABS Base + Plastic Plate  
Lamp: 5W(Red LED + Blue LED + White 4000K LED)

2 Switches on Base

Switch for PLANT: Red Light and Blue Light  
(if the light is not turned off, it will automatically shut down after 12H)

Switch for LAMP: White Light  
with 1.2m USB Cable (Table Light)

Finish: white / Black  
Glass Bucket / Tripod for Optional  
IP20

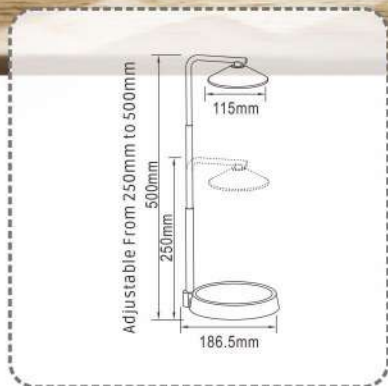

● PNLED-142

02

Home Resource Ind. Co., Ltd.

**Tall:**

With the essential Red+Blue spectrums, stems will grow taller, and leaves will grow stronger by using it 8 hours a day.

**Healthy:**

Whatever the weather, plants always receive the lights consistently which makes them grow healthier.

**Beautiful:**

Switching to general lighting mode, it makes plants prettier and makes surrounding more harmonious.



With Built-in Driver



With 2m Cable and Built-in Driver



With 2.6m USB Cable



# LED Plant Grow Light-CAGE



Material: Iron Body + ABS Base + Plastic Plate  
Lamp: 5W(Red LED + Blue LED + White 4000K LED)

2 Switches on Base

Switch for PLANT: Red Light and Blue Light  
(if the light is not turned off,  
it will automatically shut down after 12H)

Switch for LAMP: White Light  
With 1.2m USB Cable (Table Light)

Finish: White / Black

Glass Bucket / Tripod for Optional  
IP20



● PNLED-150A

**Tall:**

With the essential Red+Blue spectrums, stems will grow taller, and leaves will grow stronger by using it 8 hours a day.

**Healthy:**

Whatever the weather, plants always receive the lights consistently which makes them grow healthier.

**Beautiful:**

Switching to general lighting mode, it makes plants prettier and makes surrounding more harmonious.



● PNLED-150WLK

With Built-in Driver

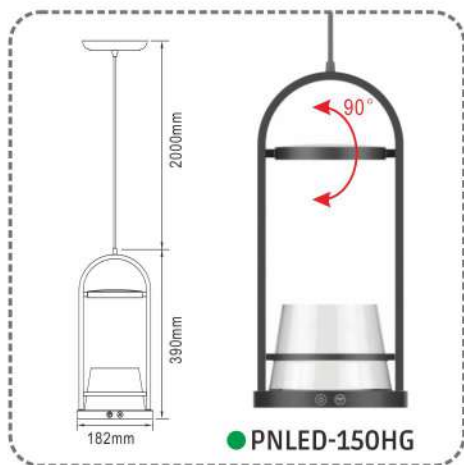

● PNLED-150HG

With 2m Cable and Built-in Driver



● TRIPOD-PNLED

With 2.6m USB Cable



# LED PLANT GROW Light

Material: Iron + ABS + Steel + Plastic Plate  
Lamp: 10W

(Red LED + Blue LED + White 4000K LED)

Color: Light Wood + White

With 2 Touch Switches on Base

-Switch for PLANT: Red Light + Blue Light  
(automatically shut down after 12 hours)

-Switch for Lamp: White Light

With Height-adjustable Tube

With 1.2m USB Cable



Adjustable from 230mm to 490mm  
Without Plastic Pot



Home Resource Ind. Co., Ltd.



Adjustable from 230mm to 490mm  
Without Plastic Pot

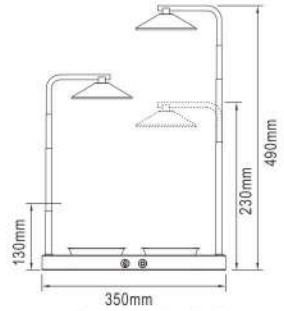

● PNLED-142-2

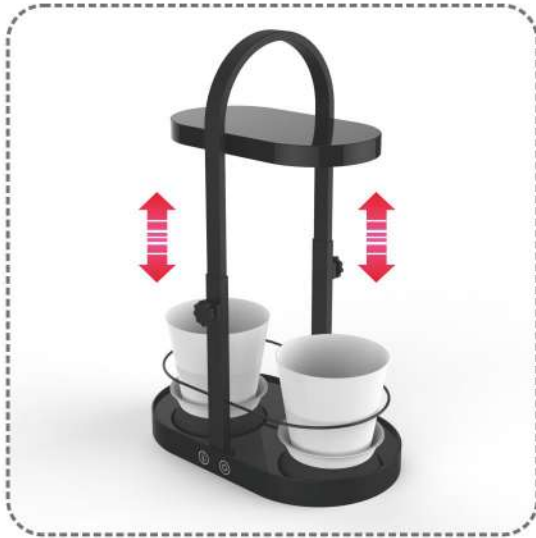

Adjustable from 230mm to 460mm  
Without Plastic Pot

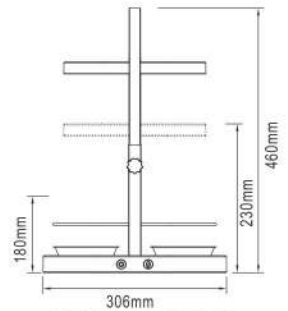

● PNLED-150-2

NEW



# Multi-pot LED

Material: Steel + ABS + Plastic  
Lamp: 10W(Red LED + Blue LED + White 4000K LED)  
With 2 Switches on Base:  
Switch for PLANT: Red Light + Blue Light  
Switch for LAMP: White Light  
Color: Light Wood + White  
Automatically Shut Down after 12H  
Height-adjustable Tube  
With 1.2m USB Cable  
With 2pcs Plastic Plates  
IP20

## Evelyn



● PNLED-148

08

Home Resource Ind. Co., Ltd.

NEW

# PLANT GROW LIGHT

## Chaya



Material: Steel + ABS + Plastic

Lamp: 10W

(Red LED + Blue LED + White 4000K LED)

With 2 Switches on Base:

Switch for PLANT: Red Light + Blue Light

Switch for LAMP: White Light

Color: Light Wood + White

Automatically Shut Down after 12H

Height-adjustable Tube

With 1.2m USB Cable

With 2pcs Plastic Plates

IP20



● PNLED-149





# LED PLANT GROW



Material: Iron + PMMA + ABS  
Lamp: 3W(Red LED + Blue LED)  
With Rocker Switch on the Cable  
With Detachable Spike  
Color: White

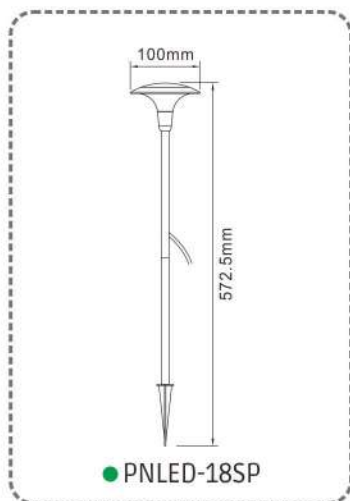



## Light with Spike

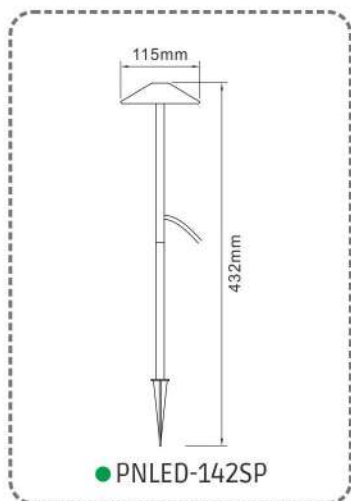

Material: Iron + ABS + PC  
Lamp: 5W(Red LED + Blue LED)  
With Rocker Switch on the Cable  
With Detachable Spike  
Color: White



NEW

# 2-WAY LED PLANT GROW LIGHT



Spike, Table

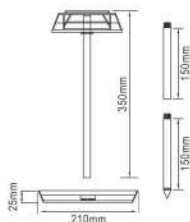

● PNLED-147



Material: ABS + PMMA  
Lamp: 5W (Red + Blue LED)  
Color: Black / white  
With Detachable Spike  
With Rocker Switch on Cable  
Automatically Shut Down after 12H  
IP20



LED Smart Lighting

# Hot Selling Smart Control

## LED Desk Lamp



Material: ABS + PP + Iron  
Lamp: 8W ( 48pcs 0.2W SMD2835 3000K + 6000K LED)  
Lumen: 220LM(3000K+6000K)~480LM(4500K)  
With 4-way Touch Switch: 20%-50%-100%-Off  
Long Press for Stepless Dimming  
With DC Plug + 1.5m Cable  
Color: White/Black

Hey Google,  
turn on the light.

Okay.

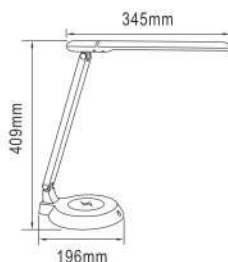

● TLED-121B

NEW

# Compatible with



Google HOME



amazon alexa

IFTTT

Wireless Charging/APP Control/Voice Control



180°

Material: ABS + PP + Iron  
Lamp: 6W (36pcs 0.2W SMD2835 LED 3000K + 6000K)  
With 4-way Touch switch: 6000K-3000K-4500K-Off  
Long press for Stepless Dimming  
With DC Plug + 1.5M Cable  
Color: White



● TLED-122B



Wireless Charging



90°

**NEW**

# Smart Control LED Desk Lamp



Material: ABS  
Lamp: 6W  
(36pcs 0.2W SMD2835 3000K+6000K)  
Lumen: 400LM

With 4-way Touch Switch: 3000K-6000K-4500K-Off  
Long press for Stepless Dimming  
With USB charger: 5V, 2.1A  
With TL/UL Adaptor: 12V, 1.5A  
With LED Display  
Color: Black



● TLED-218U



Wireless Charging

# Compatible with



Material: ABS + Iron  
Lamp: 8W (22pcs 0.2W SMD2835 4000K LED)  
With 4-Way Touch Switch: 20%-50%-100%-Off  
Color: White  
With DC Plug + 1.5m Cable

180°



Okay.

Hey Alexa,  
set the light to  
30% bright.



● TLED-120

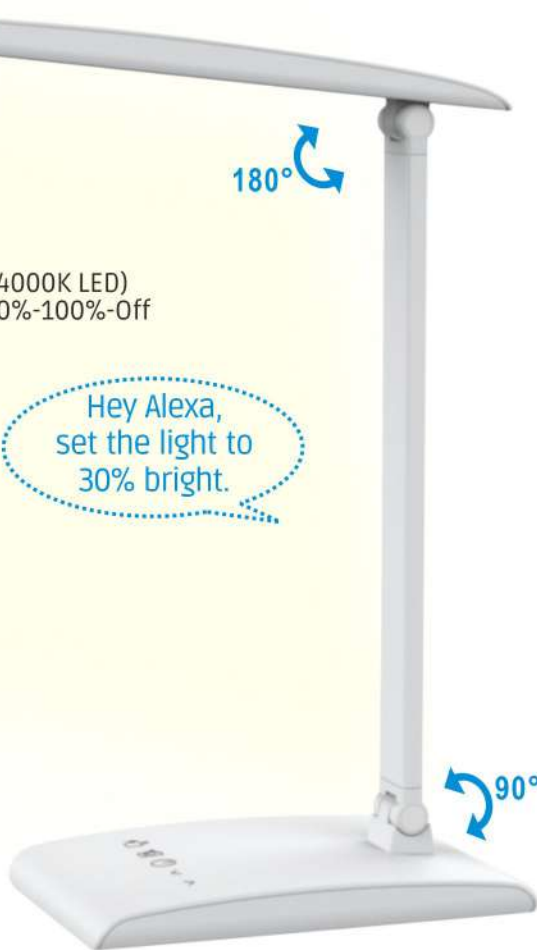

90°

# Smart Control Reading Wall Light

with USB Slots



Hey Alexa,  
set the wall light to  
party mode.



Material: Iron + Aluminum + Fabric  
Lamp: 1.5W White LED(Incl.)  
+ E27 14W LED Bulb(Excl.)  
Finish: Satin Nickel  
With 2 Toggle Switches on Base  
With Built-in Driver  
With 2 USB Slots

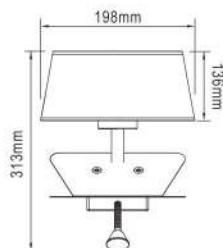

● WLED-225W



Material: Iron + Aluminum + Fabric  
Lamp: 1.5W White LED(Incl.)  
+ E27 14W LED Bulb(Excl.)  
Finish: Satin Nickel  
With 2 Toggle Switches on Base  
With Built-in Driver  
With 2 USB Slots



Google HOME



amazon alexa

**IFTTT**

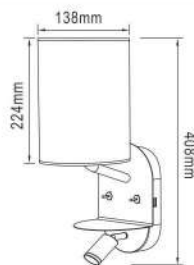

● WLED-226W



# Smart Control



180°

Hey Google,  
set the flood light  
to party mode.

Okay.

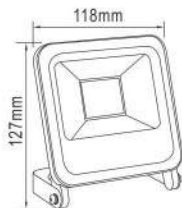

● FLED-513W-10

Material: Die Cast Aluminum  
Build-in Junction Box  
Finish: Black  
IP65

●	Lamp	Lumen	Product size(mm)
FLED-513W-10	10W	750LM	L118xW43xH127
FLED-513W-20	20W	1500LM	L126xW43xH142

# LED Flood Light



Google HOME



amazon alexa

**IFTTT**

**Wireless Charging/APP Control/Voice Control**

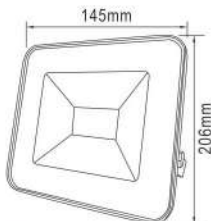
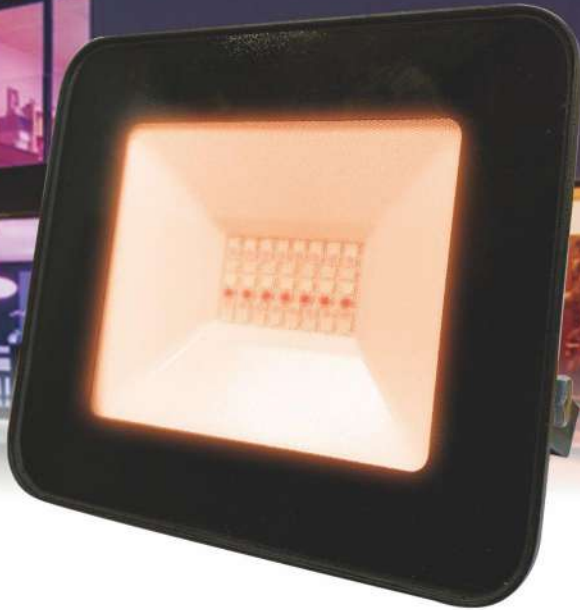

● FLED-514W-20

Material: Die Cast Aluminum + PC + Glass  
AC220-240V 50/60HZ  
Cable: 15cm H05RN-F 3Gx1.0mm  
Finish: Black  
CRI>80  
IP65

●	Lamp	3000K	4000K/6000K	Product size(mm)
FLED-514W-20	10W	1500LM	1600LM	L145xW35xH206
FLED-514W-30	20W	2250LM	2400LM	L145xW35xH206
FLED-514W-50	50W	3750LM	4000LM	L173xW38xH235

# Smart Control

## Exterior Garden Light

Wireless Charging/APP Control/Voice Control



Hey Alexa,  
set the wall light to  
party mode.



● ELED-395WI

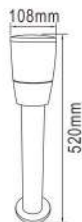

● GPLED-395W  
(0.52m)

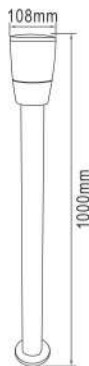

● GPLED-395W  
(1m)



Material: Aluminum-Die Cast + PC Diffuser  
Input Voltage: AC220-240V/50-60HZ  
Lamp: 6W SMD LED  
Lumen: 310LM  
Color: Black  
IP54

LED Novelty Light

NEW

# Rechargeable



# LED Mood Light



Material: PS+ PP+Iron  
Lamp: 0.48W(0.06 x 8pcs  
SMD2835 4000K LED)  
Battery: 1pc x 3.7V 1200mAh  
18650 Li Battery  
Battery Charging Time: 1-3H  
Battery Working Time: 2-6H  
4-way Touch On/Off Switch:  
20%-50%-100%-Off

## Armin



● ETLED-53B

## Cade

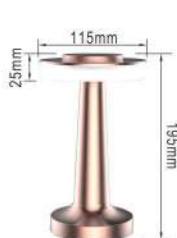

● ETLED-53C



● ETLED-53E

## Elmo



● ETLED-53D

● ETLED-181



Material: ABS Top & Body + PMMA Diffuser

Lamp: 12 × 0.06W LED

Lumen: 60LM(6000K)

Battery Working Time: 36H (3 × AA Excl.)

With Touch On/Off Switch

Color: Black/White



# LED MOOD LAMP JELLYFISH



# LED Mood Lamp

## Eileen

## Eudora



Material: ABS + PP

Lamp: 8W(12 × 0.7W SMD2835 3000K LED)

Battery Working Time: 9H (3 × AA Excl.)

With Touch On/Off Switch on the Base



● ETLED-201A  
Eileen



● ETLED-201B  
Eudora





**NEW**

# Detachable Wireless Charging Night Light



Material: ABS + PP  
Lamp: 0.8W (0.2W x 12pcs SMD2835 LED 3000K)  
Wireless Charger: 10W QC2.0  
Battery: 1pc 80mAh Rechargeable Li-battery  
With On/Off Touch Switch  
Long Press for Dimming  
With 1.2M USB Cable  
Color: White



Wireless Charging



Detachable Lamp

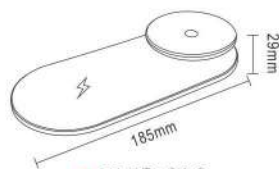

● NLED-040

Material: ABS Body + PC Diffuser  
Lamp: 1W (10pcs × 0.1W SMD2835 3000K LED)  
Power: 3.2V, 6mA  
Battery: 3 × AAA(Excl.)  
Battery Working Time: > 24H  
Color: White + Black  
Touch On/Off Switch

Hot Selling



# Drawing ROLY-POLY Mood Light

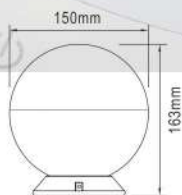

● KLED-61A

# LED Make-up Mirror Light **VENUS**



Material: ABS + Iron + Glass  
Lamp: 1.8W (29pcs × 0.06W SMD2835 6000K LED)  
Battery: 1pc Built-in 1200mAh 18650 Battery  
Battery Charging Time: 4-6H  
Battery Working Time: 2-12H  
Stepless Dimming  
Color: Light Pink / White  
With 1.2M USB Cable

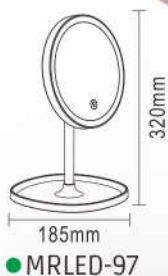

LED Desk Lamp

Hot Selling



# Portable LED RECHARGEABLE Desk Lamp

● TLED-113



Material: ABS + Iron + PC  
Lamp: 3.6W (2×18pcs 0.2W SMD2835  
3000K+6000K LED)

Lumen: 230LM  
Battery: 3.7V 1600mAh 18650  
Battery Charging Time: 6-8H  
Battery Working Time: 4-12H

4-Way Touch Switch:  
6000K-3000K-4500K-Off  
Color: White / Black  
With 1.2m USB Cable

NEW

# Leather-like Desk Lamp with LED Clock

With Wireless Charger



Material: ABS

Lamp: 6W (36pcs 0.2W SMD2835 3000K+6000K)

Lumen: 400LM

With 4-way Touch Switch: 3000K-6000K-4500K-Off

Long press for Stepless Dimming

with USB charger: 5V, 2.1A

with TL/UL Adaptor: 12V, 1.5A

with LED Display

Color: Black



Wireless Charging



● TLED-218U



180°

90°

**NEW**

# NEW DESIGN LED Desk Lamp



180°

Material: ABS + PP + Iron  
Lamp: 6W (36pcs 0.2W SMD2835 LED 3000K + 6000K)  
With 4-way Touch switch: 6000K-3000K-4500K-Off  
Long press for Stepless Dimming  
With DC Plug + 1.5M Cable  
Color: White



● TLED-122B

90°



Wireless Charging

Material: ABS + Iron  
Lamp: 8W (22pcs 0.2W SMD2835 4000K LED)  
With 4-way Touch Switch: 20%-50%-100%-Off  
Color: White  
With DC Plug + 1.5m Cable



● TLED-120



## Hot Selling

Material: ABS + Iron  
Lamp: 8W (22pcs 0.2W SMD2835 4000K LED)  
With On/Off Touch Switch  
Long Press for Dimming  
Color: White/Black  
With DC Plug + 1.5m Cable



● TLED-121B





**NEW**

# Metallic Desk Lamp



- TLED-163C
- TLK-163C

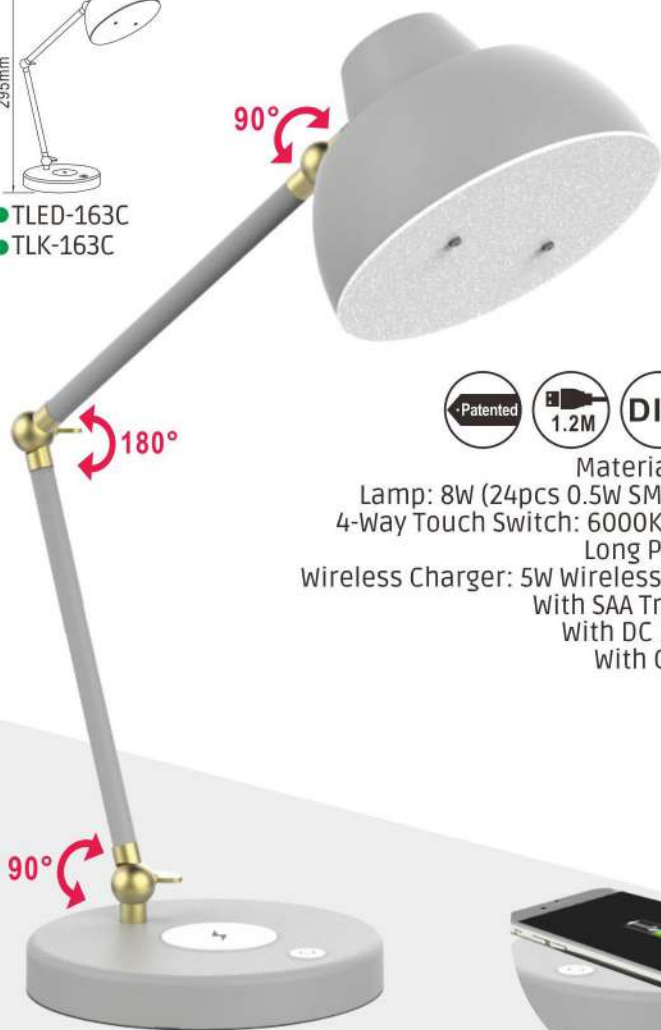

Material: PC + ABS + Iron  
Lamp: 8W (24pcs 0.5W SMD2835 3000K LED)  
4-Way Touch Switch: 6000K-3000K-4500K-Off  
Long Press for Dimming  
Wireless Charger: 5W Wireless Charging Module  
With SAA Transformer + Plug  
With DC Plug + 1.5m Cable  
With QC 2.0 USB Output  
Finish: Gray



Wireless Charging

NEW

# with Wireless Charger

LED/E27 Bulb



- TLED-164C
- TLK-164C



Material: PC + ABS + Iron  
Lamp: 8W (24pcs 0.5W SMD2835 3000K LED)  
4-Way Touch Switch: 6000K-3000K-4500K-Off  
Long Press for Dimming  
Wireless Charger: 5W Wireless Charging Module  
With SAA Transformer + Plug  
With DC Plug + 1.5m Cable  
With QC 2.0 USB Output  
Finish: Gray

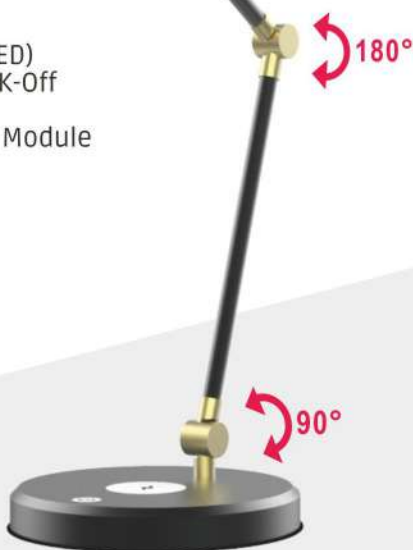

Wireless Charging

**NEW**

# LED RECHARGEABLE CLIP Light

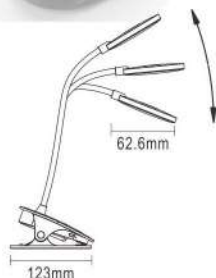

● TCLED-224



Material: ABS + Steel + PP  
With 3W (24pcs 0.2W SMD2835 LED 3000K)  
Touch On/Off Switch: Long Press for Dimming  
Battery: 1pc Built-in 1200mAh 18650 Battery  
Battery Charging Time: 4-6H  
Battery Working Time: 2-8H  
With 1.2M USB cable  
Color: white



Material: ABS Body + Iron & Silicone Tube  
Lamp: 3W (22pcs 0.2W SMD2835 4000K LED)  
Touch On/Off Switch: Long Press for Dimming  
Battery: 1pc Built-in 1200mAh 18650 Battery  
Battery Charging Time: 4-6H  
Battery Working Time: 2-8H  
Color: White / Black  
With 1.2M USB Cable



● TCLED-221



Material: ABS + Iron  
Lamp: 3.6W (18pcs 0.2W SMD2835 4000K LED)  
Touch On/Off Switch: Long Press for Dimming  
Battery: 1pc Built-in 1200mAh 18650 Battery  
Battery Charging Time: 4-6H  
Battery Working Time: 2-8H  
Color: White / Black  
With 1.2M USB Cable

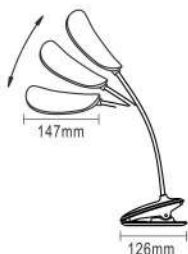

● TCLED-222





**HOME RESOURCE IND. CO., LTD.**  
Home Resource LEDS The World

**The 31st Home Resource Prize Golf Invitation Tournament**  
to be held at Agile Golf & Country Club, Zhongshan, China

**EXPECT YOUR PATICIPATION**



■ **Home Resource Golf Team**

Welcome Your Participation for a Friendly Golf Competition



Please contact us: [hr@homerresource.com.tw](mailto:hr@homerresource.com.tw)

SINCE 1988 HOME RESOURCE  
31<sup>st</sup>  
ANNIVERSARY

*Manufacturer • Buying Agent • Inspection Agent*



**Home Resource Ind. Co., Ltd.**

Taipei Headquarter:

4F, No. 69-5, Sec. 2, Chungcheng East Rd., Tamshui Dist., New Taipei City, Taiwan

China Factory:

No.8, Yanjiang W. 1st Rd., Keji Ave., Torch Development Zone, Zhongshan City, Guangdong

Tel: 886-2-2809-1212 (Rep. 12 Lines)

Fax: 886-2-2808-1565

E-mail: [hr@homerresource.com.tw](mailto:hr@homerresource.com.tw)

<http://www.homerresource.com.tw>



ISO 9001