

2022

NEW EDITION PART 1



OUTDOOR LIGHTING



Home Resource Ind. Co., Ltd.
Home Resource LEDS The World



HOME RESOURCE HISTORY TIMELINES

- 2021 Winner of the iF Design Award, Germany 
- 2017 Received The Best Innovation Award of Taiwan Lighting Association
- 2015 Received National Excellent Lighting Quality Award in Japan
- 2013 Awarded the BSCI certification
- 2010
 - Established New Factory in Zhongshan (Guangdong)
 - Established the Research & Development Center
- 2008
 - Red Dot Design Award, Germany 
 - Good Design Product, Taiwan 
- 2007 Awarded as one of the best "ISO 9001:2000" companies listed as members of KEMA organization
- 2006 Acquired 26,000 square meters land in Zhongshan City, Guangdong
- 2005 Received National Quality Award in Taiwan
- 2004 President Sam Chen was being the Chairman of Taiwan Lighting Association (2004-2007)
- 2003
 - Awarded from TUVPS as one of the TOP 5 Golden Clients in Asia
 - Founded the scholarships in Longung Elementary School in Taichung City, Taiwan
- 1999
 - Established Home Resource in Qinxi, Dongguan (Guangdong)
 - Awarded the ISO 9001:2000 certification
- 1998 Established Charitable Memorial Foundation of caring for the elderly
- 1997 Established Home Resource Golf Team
- 1996 Received Excellent Quality Award, Spain
- 1995 HR being the 1st Taiwanese company in receipt of SEMKO, NEMKO, and DEMKO Certificates
- 1992 Established Home Resource in Shanghai/Ningbo
- 1988 Established Home Resource Ind. Co., Ltd. in Taiwan



OUR VISION

To Illuminate Every Part of the World

OUR MISSION

- Be one of the best lighting manufacturers in Taiwan and China
- Pursue sustainability, build to last concept, truth/goodness/beauty as an ideal state

PHILOSOPHY & COMPANY CULTURE

- Our promise to customers:
 1. Quality guaranteed
 2. Fast lead time
 3. Competitive price
 4. Continuously launch products
 5. Homeresource=Responsibility=Warranty
- We keep pursuing excellence & perfection forever
- There is no best, only better

OUR CORE COMPETENCE

- Integrity
- Innovation
- Passion
- Efficiency
- Responsibility
- Teamwork

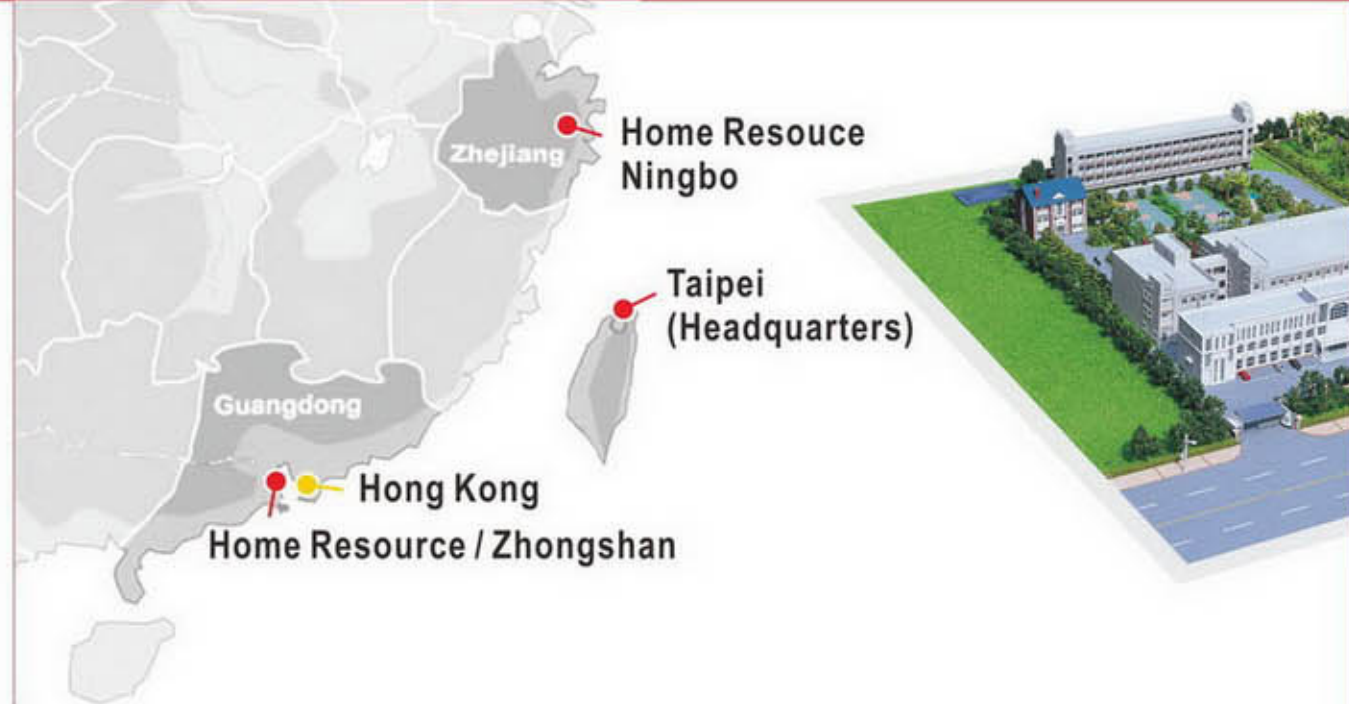

Taipei



Zhongshan



Ningbo

China Factory

Our own factories are located in ZhongShan, Guangdong, China (26,000 square meters) and Ningbo, Zhejiang, China (7,000 square meters). We remain 100% dedicated to our quality management, and our factory has certifications of ISO 9001/ TÜV GS/ SEMKO/NEMKO/ FI/DEMKO/UL/CSA/CUL.

Zhongshan Home Resource Factory

Location: Zhongshan City, Guangdong Province, China
Facility Size: 26,000 m²

Ningbo Home Resource Factory

Location: Ningbo, Zhejiang Province, China
Facility Size: 7,000 m²



PRESIDENT'S MESSAGE

Sam Chen Psy.D.

- Chairman of TLFEA (2004-2007)
TLFEA: Taiwan Lighting Fixture Export Association
- Director of CEECA and LABC
CEECA: The Central, Eastern Europe and CIS Association
LABC: Latin American Business Council
- Vice Chairman of Taiwan Investors Association in Zhongshan
-  Rotary Member

Since its establishment in 1988, Home Resource Ind. Co., Ltd. has been dedicated to production and development of lighting products for three decades.

We would like to take this opportunity to express our sincere appreciation for your fully supports and concerns over the past 33 years.

With years of efforts on upgrading production capability and capacity, Home Resource has grown into a consummate manufacturer of lightings on OEM and ODM basis. Globally reputed R&D talent has also helped Home Resource to enhance popularity and recognition of its own-brand products in recent years.

In addition to existing branches, Home Resource has opened a constructed plant of 26,000 square meters in China(Zhongshan City, Guangdong Province), which employs advanced production equipment to assure even shorter delivery and more considerate services for clients than before.

We strive for success not only in having determination and courage, but also developing innovative products and marketing intelligence base on our core competence: innovation,

David Chen Vice President



efficiency, integrity and passion. Home Resource will definitely get hold of past success to carry on growing continuously in the lighting territory now and then. Let's witness the brand new, prosperous Home Resource to achieve an even higher peak of success in the coming future.

Home Resource was established in 1988. Since then, the company has developed into one of the most professional lighting manufactures in Taiwan and Mainland China.

Home Resource would like to express our sincere thanks to all customers, every one of our employees. It is their continuing support and hard work that has allowed Home Resource to grow as rapidly as they have been able to. HR will continue to make even greater efforts in the future.

We strive to attain a position of long-term, sustainable pre-eminence in the lighting field "lighting up" both our customers and ourselves.

We look forward to working with you all continuously to create a brilliant future.

中山偉聖照明有限公司
HOME RESOURCE IND. CO., LTD. (Zhongshan)
GREEN RESOURCE ILLUMINATION CO., LTD.

HOME RESOURCE

HAS RECEIVED THE FOLLOWING AWARDS:

Design Awards:



• iF Design Award of Germany



• Reddot Award of Germany



L: Sam Chen
(President of Home Resource)
R: P. K. Chiang
(Minister of Economic Department, Taiwan)
• Being as Chairman of
Taiwan Lighting Association (2004)



• Good Design Product of Taiwan



L: Sam Chen
(President of Home Resource)
R: Alfred Albrecht, TUVPS
(GTS Testing & Certification)
• Awarded from TUVPS as one of the
Top 5 Golden Clients in Asia (2003)



David Chen
(General Manager of Home Resource)
• Received Innovation Award for
Mushroom Lamp in 2008 Frankfurt
Light + Building Exhibition.



L: Jack Chen
(Former President of HR & GR)
R: Representative of Senior Group
• Awarded from Senior Group
towards annual charity donation

Certifications:

CE, GS, CUL, ETL



GS Certificate

CUL, ETL Certificate

More than 80 US/EU patents:



INDEX

EXTERIOR LIGHT

◆Path Light, Wall Light -----	01~49
◆Lantern -----	50~64
◆Garden Light -----	65~75
◆LED Deck Light Set -----	76~84
◆Flood Light, Work Light -----	85~97
◆Bulkhead -----	98~103
◆Security Light -----	104~108
◆Party Light -----	109~112
◆Tri-Proof, High Bay, Garden Socket -----	113~118

**WALL LIGHT
PATH LIGHT
LANTERN**

NEW
Products



OUTDOOR LANTERN CANE SERIES

Material: Aluminum Body + Glass Diffuser
Bulb Adaptable: E27 60W Max
Voltage: 110-240V 50/60Hz



● EL-1140HG

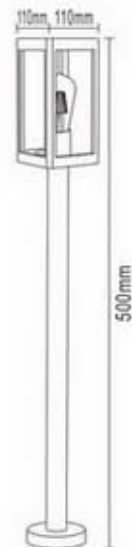

● EL-1140BP1 ● GPL-1140B



● EL-1140BUP



● EL-1140BDN

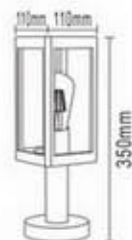

● EL-1140BP1

NEW
Products



OUTDOOR LANTERN FUCHSIA SERIES

Material: Aluminum Body + Glass Diffuser
Bulb Adaptable: E27 40W Max
Voltage: 110-240V 50/60Hz

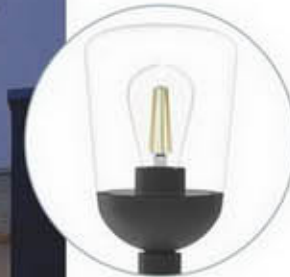

2 Types Available

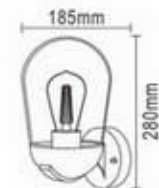

● EL-135UP

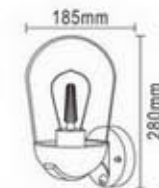

● EL-135UPS



● EL-135HG



● EL-135P1



● GPL-135

NEW
Products



OUTDOOR LANTERN BELL SERIES

Material: Aluminum Body + PC Diffuser
Bulb Adaptable: LED G9 6W Max
Voltage: 220-240V

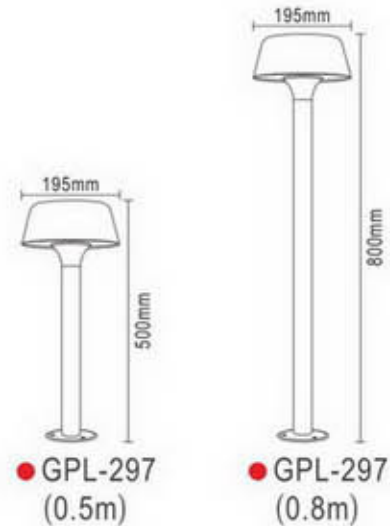

NEW
Products



OUTDOOR LANTERN SQUARE PODS

Material: Aluminum Body + PC Diffuser
Lamp: 10W(24 pcs SDM2835 LED)
Voltage: 110-240V



● ELED-185

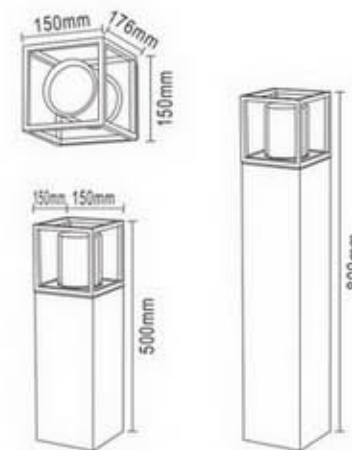

● GPL-185 (0.5m)



● GPL-185 (0.8m)

NEW
Products



OUTDOOR LANTERN ROUND PODS

Material: Aluminum Body + PC Diffuser
Lamp: 10W(24 pcs SDM2835 LED)
Voltage: 110-240V



● ELED-187



● GPLED-187 (0.8m)



● GPLED-187 (0.5m)

LED OUTDOOR WALL SCONCE



Material: Die-Cast Aluminum + Glass
Lamp: 9.8W(3000K LED)
Voltage: 100-240V
Color: Black
IP54

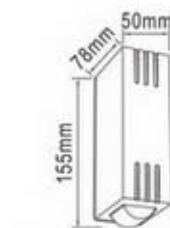

● ELED-177-2



LED COVER WALL LIGHT



Delivered Lumens: 500
Watts: 13W
Voltage: 120V/100-240V
Mounting Options: Wall
CCT: 3000K
CRI: 80+
IP65

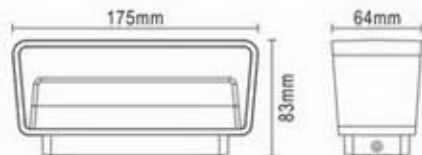

● ELED-642

LED SPIN WALL LIGHT



Delivered Lumens: 600
Watts: 13W
Voltage: 120V/100-240V
Mounting Options: Wall
CCT: 3000K
CRI: 80+
IP65

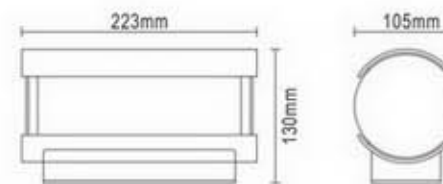

● ELED-644

MODERN UP & DOWN LED WALL LAMP

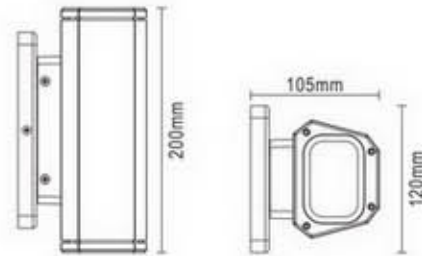

● ELED-646B

Delivered Lumens: 680
Watts: 11W
Voltage: 100-240V
Beam Angle: 266 °
Mounting Options: Wall
CCT: 3000K
CRI: 80+
IP65

2 IN 1 ADJUSTABLE LED WALL LAMP



Delivered Lumens: 400
Watts: 11W
Voltage: 100-240V
Beam Angle: 217 °
Mounting Options: Wall
CCT: 3000K
CRI: 80+
IP65

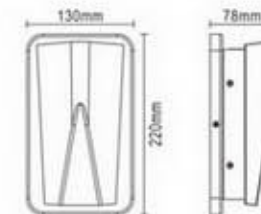

● ELED-645

LED BOX WALL LAMP



Delivered Lumens: 800
Watts: 13W
Voltage: 120V/100-240V
Mounting Options: Wall
CCT: 3000K
CRI: 80+
IP65



● ELED-506

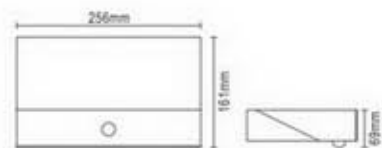
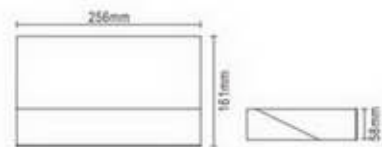

● ELED-506S

LED CURVE WALL LAMP

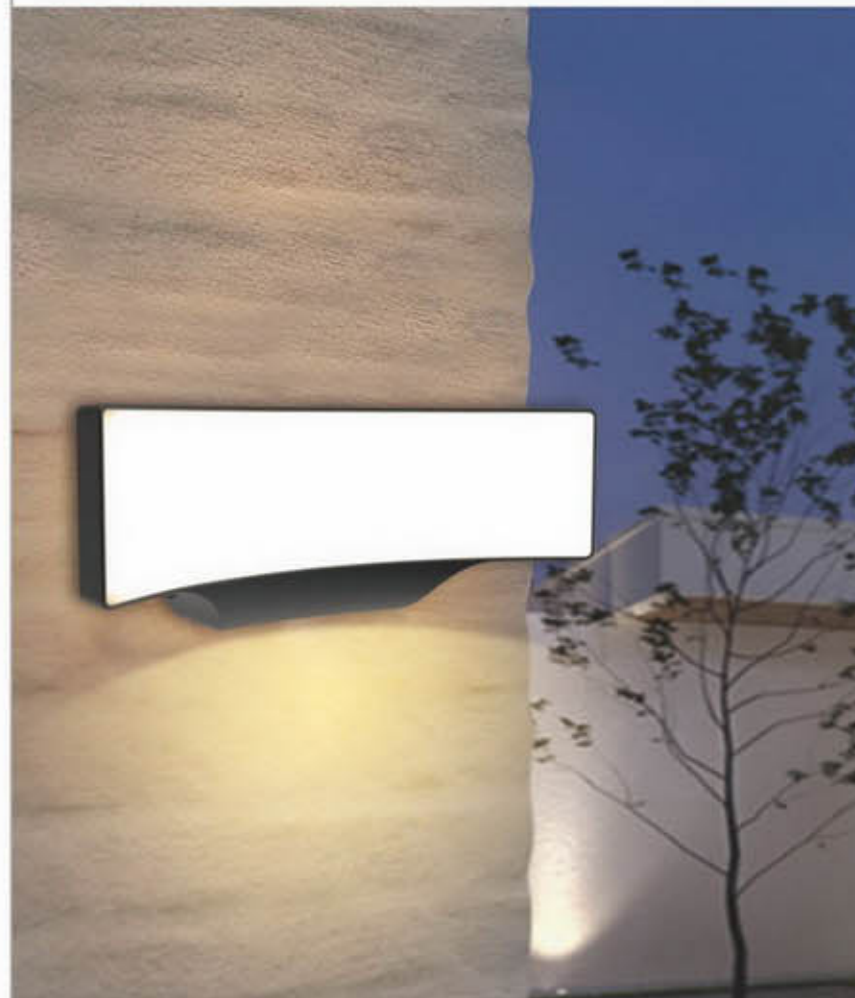

● ELED-643

Delivered Lumens: 980
Watts: 12W
Voltage: 100-240V
Beam Angle: 110.9°
Mounting Options: Wall
CCT: 3000K
CRI: 80+
IP65

LED PLASTIC LANTERN



Material: PP Housing + PC Diffuser
 Voltage: 110-240V
 Mounting Options: Wall
 Bulb: Max. 18W/ Max. 60W (excl.)
 IP44



● EL-P251UP



● EL-P466DN



● EL-P458UP

LED PLASTIC LANTERN



Material: PP Housing + PC Diffuser
 Voltage: 110-240V
 Mounting Options: Wall
 Bulb: Max. 18W/ Max. 60W (excl.)
 IP44



Opal



Clear

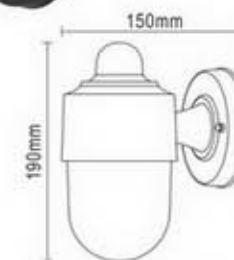

● EL-P455DN



● EL-P456DN

HOT
Selling



WALL/CORNER FIXING 2-IN-1 LAMP

Material: PC
Lamp: 12W(14pcs SMD2835 4000K LED)
Lumen: 900LM
Color: White/Black
With Detachable Corner Bracket
Ra: 80
IP44



Corner Installation



Wall Installation



Detachable

Corner Bracket

- ELED-083DN (Basic)
- ELED-083DN-PH (Photocell)

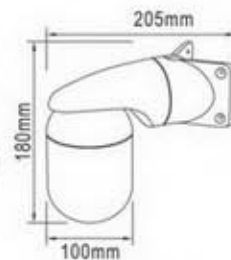

- ELED-083DNS (PIR Sensor)

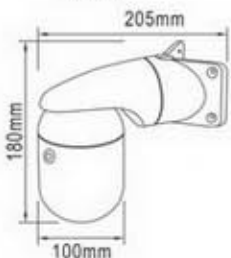

LED EXTERIOR WALL LIGHT

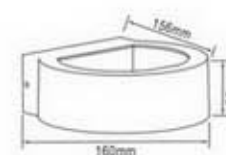

● ELED-634A



● ELED-634B

Material: Die-cast Aluminum
Input Voltage: 220-240V/50-60Hz
Lamp: 1 x 6W CREE LED
Color: black
IP54

HOT
Selling



LED EXTERIOR WALL LAMP

LED EXTERIOR WALL LIGHT



Material: Aluminum + Glass
Voltage: 110V-240V
SMD MAX: 12W
Lumen: 555LM
Color: Black
IP54

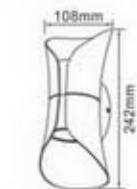

● ELED-501

Material: Aluminum + Glass
Voltage: 110V-240V
Lamp: 9.7W(60PCS x SMD2835 LED)
Lumen: 322LM
Color: White
IP44

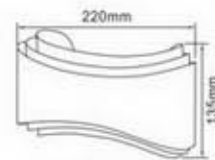

● ELED-502

LED EXTERIOR WALL LIGHT



Material: Die-cast Aluminum + Acrylic
Input Voltage: 220-240V/50-60Hz
Lamp: 8W(48pcs x SMD LED)
Color: black
IP54

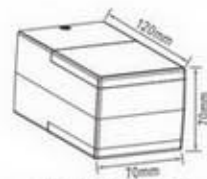

● ELED-632-2

LED EXTERIOR WALL LIGHT



Material: Die-cast Aluminum + PC
Input Voltage: 220-240V/50-60Hz
Lamp: 12W(2pcs COB LED)
Color: black
IP54

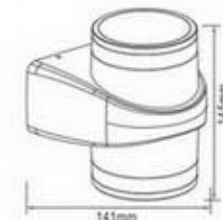

● ELED-635

HOT
Selling

LED EXTERIOR ROTATABLE WALL LIGHT



Material: Die-cast Aluminum + PC
Input Voltage: 220-240V/50-60Hz
Color: black
IP54

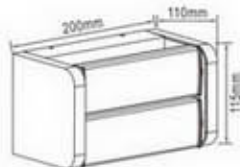

● ELED-630-2
Lamp: 12W(48pcs x SMD LED)

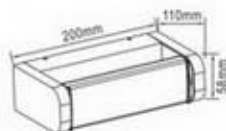

● ELED-630
Lamp: 6W(24pcs x SMD LED)

LED EXTERIOR ROTATABLE WALL LIGHT



Material: Die-cast Aluminum + Acrylic
Input Voltage: 220-240V/50-60Hz
Color: black
IP54

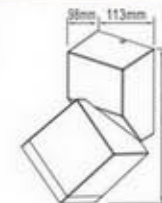

● ELED-631
Lamp: 6W(24pcs x SMD LED)

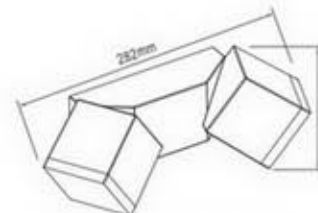

● ELED-631-2
Lamp: 12W(48pcs x SMD LED)



LED EXTERIOR ADJUSTABLE **WALL** LAMP

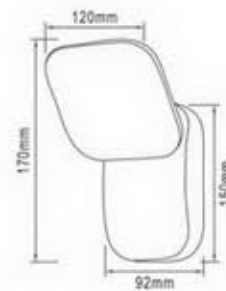

● ELED-058

Material: Aluminum-Die Cast + PC
Lamp: 12.5W(36pcs x SMD 2835 LED)
Lumen: 1007LM
Voltage: 220-240V
Color: Black
With Built-in Driver
IP54

LED EXTERIOR **WALL** LIGHT



Material: Aluminum-Die Cast+ PC
Lamp: 12W(60pcs x SMD 2835 LED)
Lumen: 830LM
Voltage: 110V-240V
Color: Black
IP44

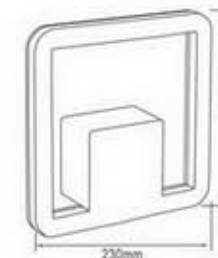

● ELED-060



LED EXTERIOR WALL LIGHT



Material: Aluminum-Die Cast + PC
 Lamp: SMD 8W LED
 Lumen: 353LM
 Voltage: 220-240V
 Color: Black
 IP54



● ELED-395



● ELED-395S

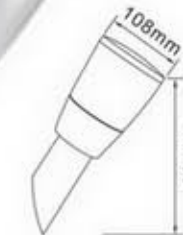

● ELED-395W



● GPLED-395 (1m)

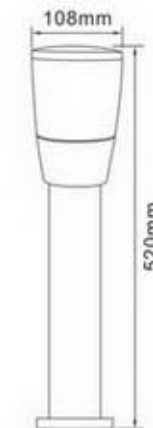

● GPLED-395 (0.52m)



LED EXTERIOR WALL LIGHT



With Sensor
 Detection Range: 160°
 Detection Distance: Max 6M
 Detection Time: 10sec-7min



Material: ABS+PC
 Lamp: 6W(27pcs x SMD2835 4000K LED)
 Lumen: 300LM
 Color: White/Black/Gray
 IP65

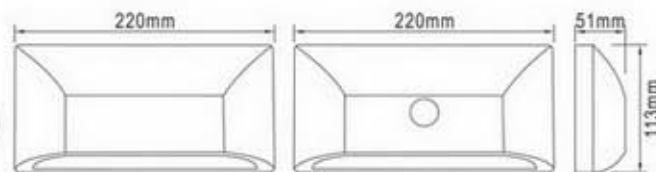

● ELED-337

● ELED-337S

LED EXTERIOR WALL LIGHT

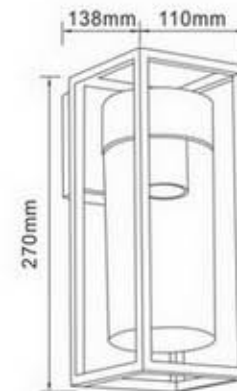

● EL-1140A

Material: Aluminum-Die Cast + PC
 Lamp: Built-in 3W (1x3W) LED + E27 6W LED Bulb (Excl.)
 Finish: Black

LED MODERN WALL LAMP



Material: Aluminum Die-casting + PC
Voltage: 220-240V / 50Hz
Color: Black
With Built-in Driver
IP54

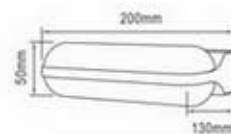

● ELED-121
Lamp: 13W SMD LED

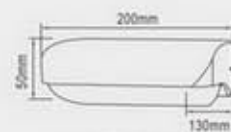

● ELED-122
Lamp: 7.5W SMD LED

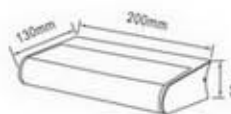

● ELED-123
Lamp: 10W SMD LED

LED GARDEN WALL/PATH LIGHT



Material: Aluminum Die-Casting + Opal PC
Voltage: 220-240V, 50Hz
Lamp: 8W SMD 2835 LED
Lumen: 600LM
Finish: Black
With Isolated Driver
IP44

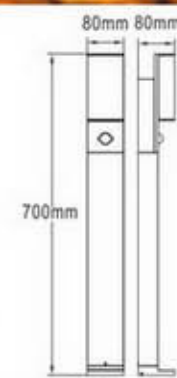

● GPLED-125S

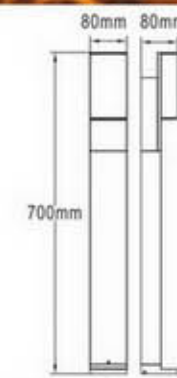

● GPLED-125

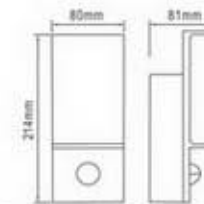

● ELED-125S

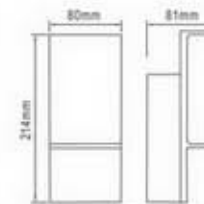

● ELED-125

LED WALL LIGHT



Material: Die Cast ABS Body + Clear Glass Diffuser
 Input Voltage: AC220-240V/50-60HZ
 Bulb Adaptable: GU10 LED 8W (Excl.)
 Color: Black
 IP44

MODERN WALL LAMP



Material: Die-casting Aluminum + PC + Glass
 Bulb Adaptable: GU10 20W Bulb (Excl.)
 Input Voltage: 100-240V
 Finish: Black
 IP44



• EL-112

LED WALL LIGHT



Delivered Lumens: 430
 Watts: 9W
 Voltage: 120V/100-240V
 Mounting Options: Wall
 CCT: 3000K
 CRI: 80+
 IP65

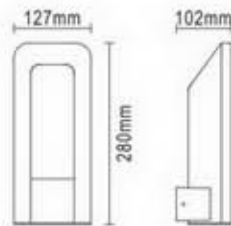

● ELED-504

LED COVER WALL LIGHT



Delivered Lumens: 800
 Watts: 13W
 Voltage: 120V/100-240V
 Mounting Options: Wall
 CCT: 3000K
 CRI: 80+
 IP65

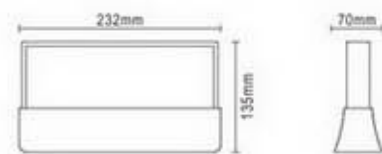

● ELED-640

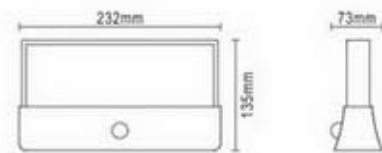

● ELED-640S



LED COVER WALL LIGHT



Delivered Lumens: 800
Watts: 13W
Voltage: 120V/100-240V
Mounting Options: Wall
CCT: 3000K
CRI: 80+
IP65

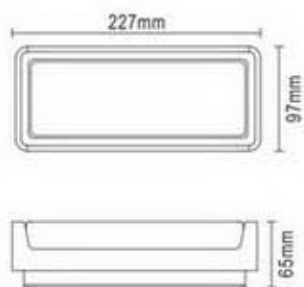

● ELED-641

LED MODERN WALL LAMP

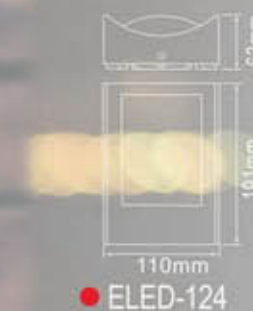

● ELED-124



● ELED-124S



Material: Aluminum Die-Casting +Opal PC
Voltage: 220-240V, 50Hz
Lamp: 6W SMD 2835 LED
Lumen: 380LM
Finish: Black
With Isolated Driver
IP44



ENERGY SAVING WALL/PATH LIGHT



Material: Die-casting Aluminum + PC
Bulb Adaptable: E27 18W Bulb (Excl)
Input Voltage: 100-240V
Finish: Black
IP44



● EL-397

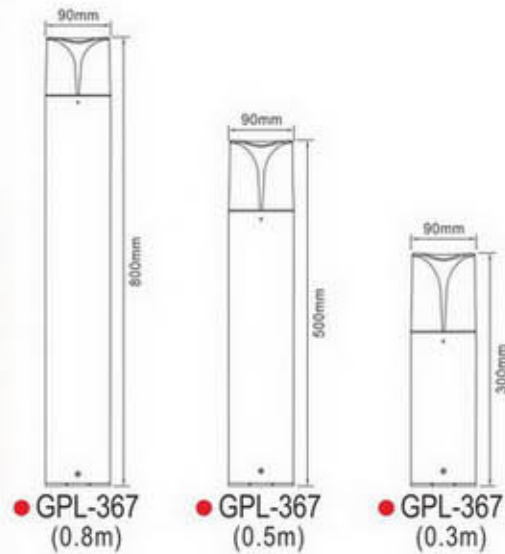

● GPL-367 (0.8m)

● GPL-367 (0.5m)

● GPL-367 (0.3m)

LED GARDEN WALL/PATH LIGHT



Material: Aluminum Body + PC & Glass Diffuser
Voltage: 100V - 240V
Color Temperature: 2700K ~ 6400K
Finish: Granulated Matt Black
IP44



● ELED-325

● GPLED-325(0.5m)

● GPLED-325(0.8m)

Lamp: 12W (2×30×0.2W SMD2835 LED)
Lumen: 760LM (4000K)

Lamp: 12W (2×30×0.2W SMD2835 LED)
Lumen: 760LM (4000K)

Lamp: 12W (2×30×0.2W SMD2835 LED)
Lumen: 760LM (4000K)



● GPLED-325A(0.8M)

● GPLED-325A(0.5M)

● ELED-325A

Lamp: 12W (2×30×0.2W SMD2835 LED)
Lumen: 650LM (4000K)

Lamp: 12W (2×30×0.2W SMD2835 LED)
Lumen: 775LM (4000K)

Lamp: 12W (2×30×0.2W SMD2835 LED)
Lumen: 680LM (4000K)

LED GARDEN WALL/PATH LIGHT

Glare-Free



Material: Alu. Body + PC Diffuser
 Lumen: 350LM (4000K)
 Color Temperature: 2700K - 6500K
 Finish: Granulated Matt Black / Grey / White
 CRI: Ra≥80
 IP54



● ELED-728 5W COB LED
 ● GPLED-728 (0.6M) 5W COB LED
 ● GPLED-728 (0.8M) 5W COB LED
 ● GPLED-728 (1M) 5W COB LED

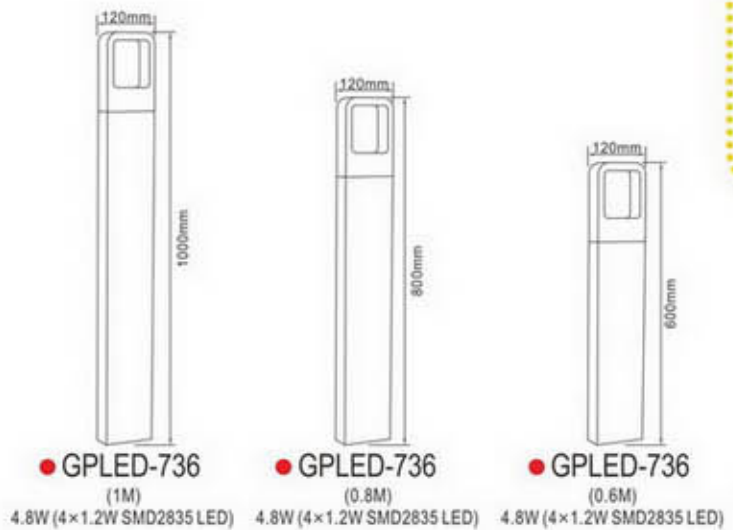

● GPLED-736 (1M) 4.8W (4×1.2W SMD2835 LED)
 ● GPLED-736 (0.8M) 4.8W (4×1.2W SMD2835 LED)
 ● GPLED-736 (0.6M) 4.8W (4×1.2W SMD2835 LED)



● ELED-736 4.8W (4×1.2W SMD2835 LED)

LED GARDEN WALL/PATH LIGHT

Material: Aluminum Body + PC Diffuser
 Voltage: 100V ~ 240V
 Lamp: 12W (60 x 0.2W SMD2835 LED)
 Finish: Granulated Matt Black
 IP44



● GPLED-328(0.8m) Lumen: 600LM (4000K)



● GPLED-328(0.5m) Lumen: 680LM (4000K)



● ELED-328DN Lumen: 680LM (4000K)

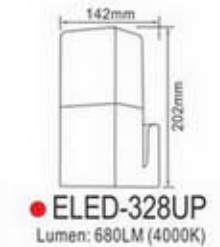

● ELED-328UP Lumen: 680LM (4000K)

Material: Aluminum Body + Glass Diffuser
 Voltage: 100V ~ 240V
 Lamp: 9W (45pcs x 0.2W SMD2835 LED)
 Lumen: 695LM (4000K)
 Finish: Black
 IP54



● ELED-285



● ELED-285S With Sensor (8M, 120°)



● GPLED-285(0.8M)



● GPLED-285S(0.8M) With Sensor (8M ; 120°)



● GPLED-285(0.5M)



ENERGY SAVING WALL/PATH LIGHT

Material: Stainless Steel + PC
 Voltage: 220~240V
 Lamp Adaptable: E27 Max 40W A60 Bulb (Excl.)
 or 23W ESB Spiral (Excl.)
 Finish: Stainless Steel
 IP44

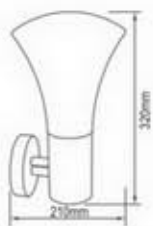

● EL-762



● GPL-762
(0.45M)



● GPL-762
(0.9M)



● GPL-857
(0.8M)



● GPL-857
(0.5M)

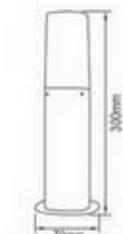

● GPL-857
(0.3M)

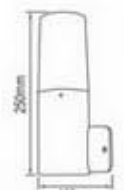

● WG-857



Material: Aluminum + PC Diffuser
 Bulb Adaptable: E27 6W LED Bulb (Excl.)
 Input Voltage: 220~240V
 Finish: Gray/Dark Gray/Black
 IP54

LED GARDEN WALL/PATH LIGHT

Material: Stainless Steel + Clear PC
 Finish: Stainless Steel
 Lamp: 6W(30 x 0.2W LED)
 Input Voltage: 100-240V
 IP44



● GPL-757
(1M)



● GPL-757
(0.5M)



● ELED-757A

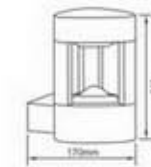

● ELED-156



● GPL-156

Material: Aluminum + PC
 Lamp: 5.4W(90 x 0.06W LED)
 Lumen: 2700K 585LM
 Finish: Dark Gray/Black
 IP54



● GPL-162



● ELED-162



STEEL GARDEN WALL/PATH LIGHT

Material: Iron + Clear PC Shade
 Bulb Adaptable: E27 10W LED Bulb A Type (Excl.)
 Finish: Matt Black
 IP44

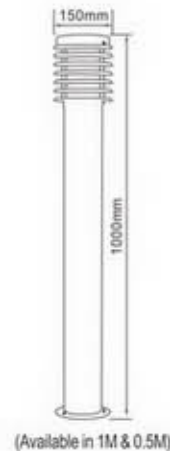
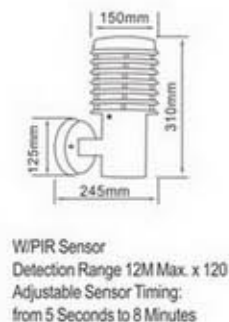

(Available in 1M & 0.5M)



● GPL-SS05

W/PIR Sensor
 Detection Range 12M Max. x 120°
 Adjustable Sensor Timing:
 from 5 Seconds to 8 Minutes

STAINLESS STEEL GARDEN WALL/PATH LIGHT

Material: Stainless Steel + PC Diffuser
 Bulb Adaptable: E27 10W LED Bulb A Type (Excl.)
 Finish: Stainless Steel
 IP44

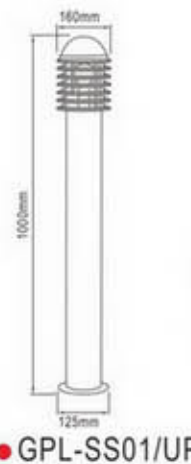

● GPL-SS01/UP



● GPL-SS01/W



● GPL-SS01

STAINLESS STEEL GARDEN WALL/PATH LIGHT

Material: Brushed Stainless Steel + Clear PC Shade
 Bulb Adaptable: E27 10W LED Bulb A Type (Excl.)
 Finish: Stainless Steel
 IP44

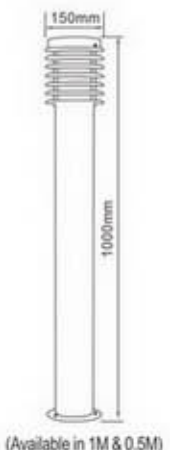
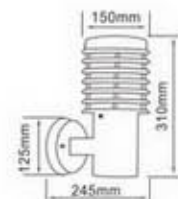

(Available in 1M & 0.5M)



● GPL-SS05-SS

W/PIR Sensor
 Detection Range 12M Max. x 120°
 Adjustable Sensor Timing:
 from 5 Seconds to 8 Minutes

ALUMINUM GARDEN WALL LIGHT

Material: Die Cast Aluminum + PC
 Bulb Adaptable: E27 10W LED Bulb A Type (Excl.)
 Finish: Black
 IP44



● GPL-01 (1M)



● GPL-01 (0.75M)



● GPL-01 (0.5M)

GARDEN WALL/PATH LIGHT

Material: Stainless Steel + Glass
 Bulb Adaptable: E27 10W LED Bulb A Type (Excl.)
 IP44

Material: Iron + Glass
 Bulb Adaptable: E27 10W LED Bulb A Type (Excl.)
 Finish: Galvanized Iron/White/Black
 IP44



● EL-555UPS
 Sensor Range: 10M x 110°



● EL-555UP



● EL-555UP

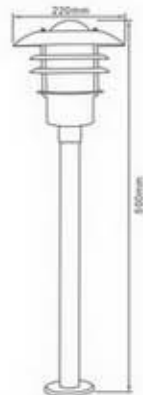

● EL-555PE2



● EL-555DN



● EL-555HG



● EL-555DN1

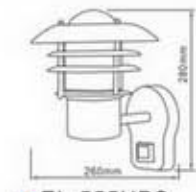

● EL-555UPS
 Sensor Range: 10M x 110°



● EL-555PE2



WATER-PROOF SPOT WALL LIGHT

Material: Stainless Steel + Glass
 Finish: Stainless steel
 Bulb Exclusive
 IP44

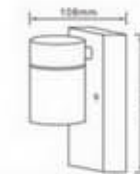

● EL-426DN
 GU10 5W LED Bulb

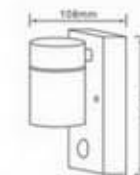

● EL-426DNS
 GU10 5W LED Bulb
 With Sensor
 Sensor Range: 8M x 120°

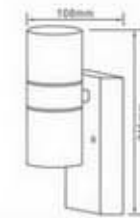

● EL-426DN-2
 2 x GU10 5W LED Bulb

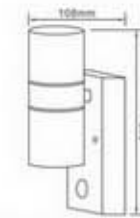

● EL-426DNS-2
 2 x GU10 5W LED Bulb
 With Sensor
 Sensor Range: 8M x 120°

Material: Aluminum Die-Casting Body + PC Diffuser
 Voltage: 220V ~ 240V
 Color Temperature: 2700K ~ 6500K
 Finish: Black / Aluminum Die-Cast
 Bulb Exclusive
 Ra > 70
 IP54



● EL-413
 Bulb Adaptable: 2 x GU10 5W LED Bulb

● ELED-413
 Lamp: 3W (1 x 3W LED)
 Lumen: 360LM(4000K)



● EL-413-2
 Bulb Adaptable: 2 x GU10 5W LED Bulb

● ELED-413-2
 Lamp: 6W (2 x 3W LED)
 Lumen: 2 x 360LM(4000K)

ALUMINUM WALL LAMP

Material: Aluminum Die-cast
 Finish: Polished
 Bulb Exclusive
 IP44



● EL-420W-1
 GU10 5W LED Bulb

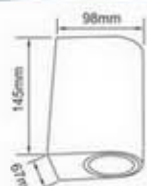

● EL-420W-2
 2x GU10 5W LED Bulb

Material: Aluminum + PC
 Lamp: 10W (20 x 0.5W LED)
 Finish: Dark Gray / Gray
 Input Voltage: 220~240V
 IP44
 Ra:>80

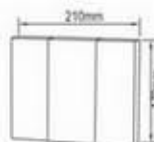

● ELED-173
 Without Sensor

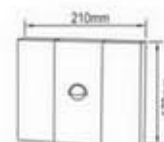

● ELED-173S
 With Sensor

Detection Range: 90° Max. 8M
 Duration Time: 10+/-5 Secs ~ 4+/-1 Mins (adjustable)

LED LIGHT-DOOR PLATE LIGHT

Glare-Free



Material: Alu. Body + PC Diffuser
 Lamp: 7.2W (6x1.2W SMD2835 LED)

Lumen: 420LM (4000K)

Color Temperature: 2700K ~ 6500K

Finish: Granulated Matt Black / Grey / White

CRI: Ra ≥ 80

IP54

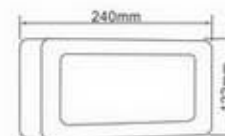

● ELED-729DP



● ELED-729DPA
 Doorplate: Numbers 0-9 Incl.

MODERN LANTERN



Material: Aluminum Die Cast Body + PC Diffuser
Voltage: AC220V-240V
Finish: Black
IP44



Material: Aluminum Die Cast Body
+ PC Diffuser
Voltage: AC220V-240V
Finish: Black
IP44



- EL-467DN
E27 / 10W LED Bulb
- ELED-467DN
10W(14pcs x 1W SMD2835 LED)
550LM(4000K)



- EL-467UP
E27 / 10W LED Bulb
- ELED-467UP
10W(14pcs x 1W SMD2835 LED)
550LM(4000K)



- GPL-467
E27 / 10W LED Bulb
- GPL-467
E27 / 10W LED Bulb
- GPL-467
E27 / 10W LED Bulb



- EL-467HG
E27 / 10W LED Bulb
- ELED-467HG
10W(14pcs x 1W SMD2835 LED)
550LM(4000K)



- EL-467P2
E27 / 10W LED Bulb
- ELED-467P2
10W(14pcs x 1W SMD2835 LED)
550LM(4000K)



- GPL-467PE3
E27 / 10W LED Bulb
- GPL-467PE3
E27 / 10W LED Bulb
- GPL-467PE3
E27 / 10W LED Bulb

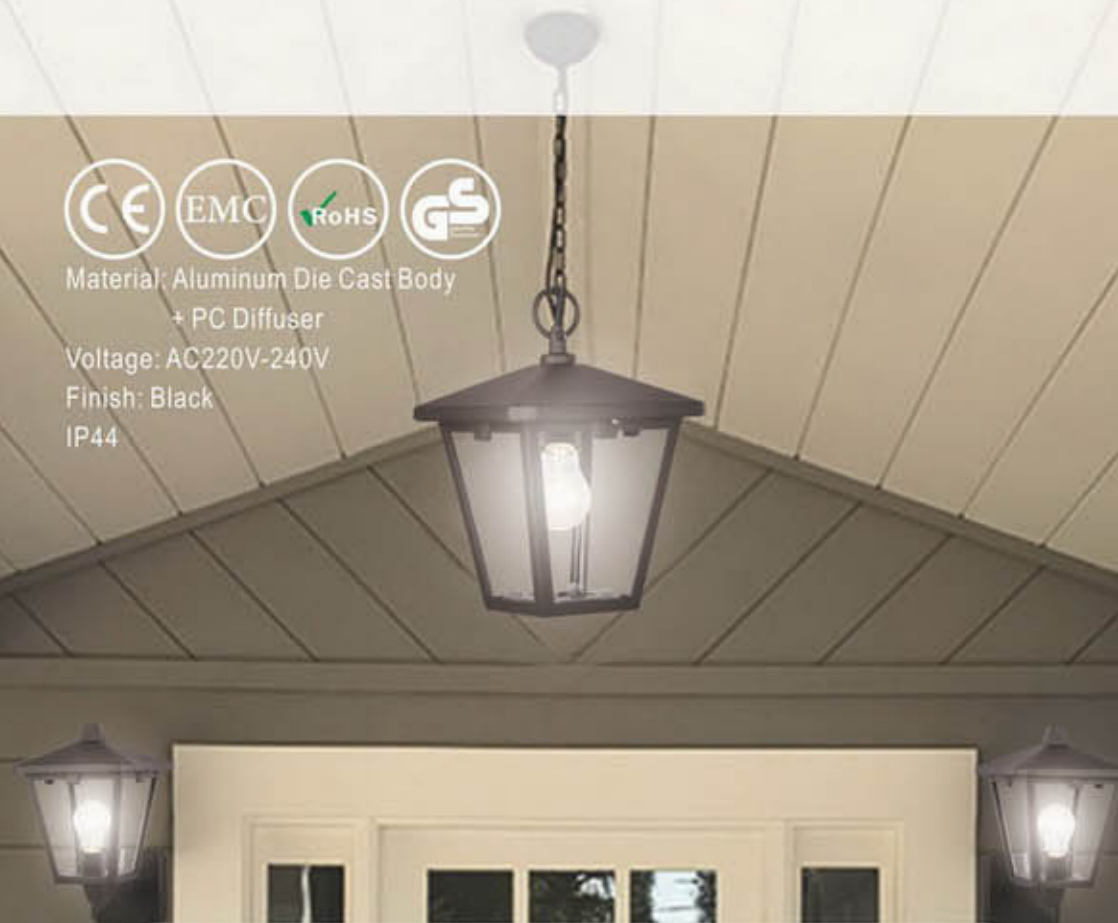

- EL-468DN
E27 / 10W LED Bulb
- ELED-468DN
10W(14pcs x 1W SMD2835 LED)
550LM(4000K)



- EL-468UP
E27 / 10W LED Bulb
- ELED-468UP
10W(14pcs x 1W SMD2835 LED)
550LM(4000K)



- EL-468P2
E27 / 10W LED Bulb
- ELED-468P2
10W(14pcs x 1W SMD2835 LED)
550LM(4000K)



- EL-468HG
E27 / 10W LED Bulb
- ELED-468HG
10W(14pcs x 1W SMD2835 LED)
550LM(4000K)



- GPL-468
E27 / 10W LED Bulb
- GPL-468
E27 / 10W LED Bulb
- GPL-468
E27 / 10W LED Bulb

LED MODERN LANTERN



Material: Aluminum-Die Cast + PC
 Lamp: 8W SMD LED
 Lumen: 640LM
 Ra>80
 Color: Black
 IP54



LED MODERN LANTERN

Material: Aluminum Die-Casting Body + PC Diffuser
 Voltage: 220V ~ 240V
 Color Temperature: 2700K ~ 6500K
 Lamp: 7W (14pcs x 0.5W SMD2835 LED)
 Lumen: 360LM (4000K)
 Ra > 70
 Finish: Black / White
 IP54

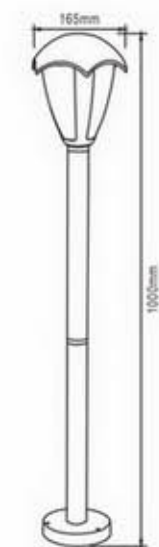

● GPLED-469

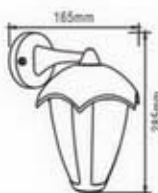

● ELED-469DN

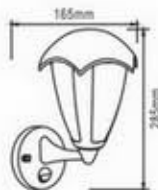

● ELED-469UPS



● ELED-469P2



● GPLED-459



● ELED-459HG



● ELED-459P2



● ELED-459UP



● ELED-459DN

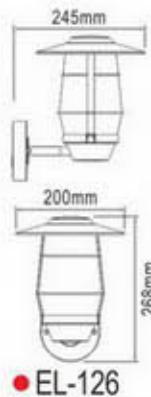

● EL-126

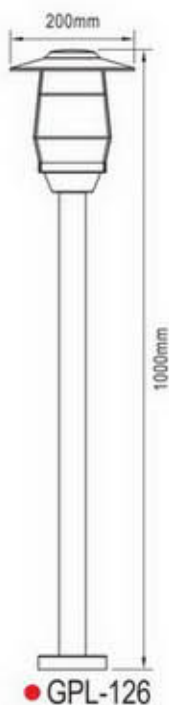

● GPL-126

ENERGY SAVING WALL/PATH LIGHT



Material: Aluminum + Iron + PC
Voltage: 110-240V, 50Hz
Color: Black
Without E27 60W Bulb (Excl.)
IP54



● EL-640UP



● EL-640DN



● EL-640PE2



● EL-640P1



● EL-640P2

Material: Die Cast Aluminum + Glass
Bulb Adaptable: E27 10W LED Bulb A Type
Finish: White/Black/Matt Rust/Black Gold/Verdi Green
IP44



● EL-560HG



● EL-560UPS



● EL-560UP



● EL-560DN



● EL-560P1



● EL-560P2



● EL-560PE3

ALUMINUM LANTERN

Material: Die Cast Aluminum + Glass
Bulb Adaptable: E27 10W LED Bulb
Finish: Black / White / Black Gold / Verdi Green
IP44

ALUMINUM LANTERN

Material: Die Cast Aluminum + Frosted Glass
 Bulb Adaptable: E27 10W LED Bulb
 Finish: Black



● EL-252UP
IP44

● EL-252UP	Product size: 24 x 20 x 44cm
● EL-252DN	Product size: 24 x 20 x 44cm
● EL-252HG	Product size: 20 x 18 x 32cm
● EL-252P2	Product size: 20 x 18 x 41cm



● EL-253DN
IP23

● EL-253UP	Product size: 23 x 16 x 29cm
● EL-253DN	Product size: 23 x 16 x 29cm
● EL-253HG	Product size: 16 x 16 x 26cm
● EL-253P1	Product size: 16 x 16 x 33cm



● EL-254DN
IP23

● EL-254UP	Product size: 24 x 18 x 37cm
● EL-254DN	Product size: 24 x 18 x 31cm
● EL-254HG	Product size: 18 x 18 x 27cm
● EL-254P2	Product size: 18 x 18 x 38cm

LANTERN IN PC

Material: PC Frame + PC Clear/Milky White Shade
 Bulb Adaptable: E27 LED 6W
 Finish: Black/White



● EL-P180APE2



● EL-P180AHG



● EL-P180AP2



● EL-P180AUP



● EL-P180ADN



● EL-P260AUP



● EL-P260AHG



● EL-P260ADN



● EL-P260AP2



● EL-P260APE2



ALUMINUM LANTERN

Material: Die Cast Aluminum + Glass
 Bulb Adaptable: E27 10W LED Bulb A Type
 Finish: Black/White/Verdi Green/
 Black Gold/Matt Rust
 IP44



● ● EL-260PE2
 Overall Ht: 1M



● ● EL-260HG

● ● EL-260DN



● ● EL-260UP

● ● EL-260UPS
 Sensor Range: 10M x 110°



● ● EL-260P2

● ● EL-260P1

ALUMINUM LANTERN

Material: Aluminum Die-Cast Body + Glass Shade
 Bulb Adaptable: G45 6W LED Bulb
 Finish: Black / White



● EL-655HG



● EL-655PE2



● EL-655P1



● EL-655DN



● EL-655UP



● EL-655UPS

LANTERN

IN PC

Material: PC(PP)

Bulb Adaptable: E27 10W LED Bulb A Type

Finish: White/Black

IP44



LANTERN

IN PP

Material: PP Body + Glass Clear Shade

Bulb Adaptable: E27 LED 6W

Finish: White / Black Body

IP44



LANTERN IN PLASTIC

Material: PC(PP)
 Bulb Adaptable: E27 10W LED Bulb A Type
 Finish: White/Black
 IP44



● ● EL-P490DN



● ● EL-P490HG



● ● EL-P490UP



● ● EL-P490P2

ALUMINUM LANTERN

Material: Die Cast Aluminum + Frosted PC
 Bulb Adaptable: E27 10W LED Bulb A Type
 Finish: White/Black/Matt Rust



● EL-341HG
IP23



● EL-341DN
IP23



● EL-341P2
IP44

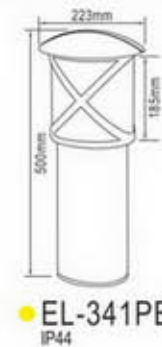

● EL-341PE2
IP44

METAL

LANTERN

Material: Iron + Clear Glass

Bulb Adaptable: E27 10W LED Bulb A Type

Finish: Black/White/Galvanized

IP44

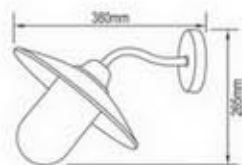

● EL-991DN



Material: Iron + Bubble Glass

Bulb Adaptable: E27 10W LED Bulb A Type

Finish: Red Antique Brass / Black

IP23



● EL-199DN



GARDEN LIGHT

NEW
Products

2 IN 1 PATH & SPIKE



Cordless Battery Operated

Material: PP + ABS + PMMA + Aluminum spike + ABS base
 Power: Dry cell Battery 3°C 1.5V (Excl.)
 Lamp: 2.5W COB LED in white (6000K)
 Lumen Output: Dimmable from 25lm to 200lm
 Working time: 40 hrs at 200lm/ 180 hrs at 25lm
 battery life at least 1.5 year (at 8 activations per day)
 PIR+ photocell sensor: (1)Delay time: 20-25s
 (2)Detection distance: 3-5 meters
 (3)Detection angle: max.90°

IP44



● GLED-182BOS

Sensor Light



Spike Mounting Plate



The high lumen battery operated path light is easy installed (no wires, no worries), while keeps your home, elders, children in SAFE surroundings.

2 in 1 Design- Spike + Mounting Plate

GLED-182BOS can be used as a garden spike for lawn; it can also be mounted on the deck, easy to TRANSFORM! A perfect solution for path lighting in the yard.



High Lumen COB + PIR Sensor

GLED-182BOS offers 200(lm) lighting output with dimming function. With the PIR sensor, the light only activates when needed.



Battery Operated & Easy Installation

The cordless design makes it widely applicable. Don't have to wire electrical plug, saving time for installation. No wires, no worries, more SAFE!



2-in-1 Battery Operated

WALL/SPIKE LED LIGHT

(with Sensor)

Material: Plastic
 Power: 2W
 Lamp: 1pc COB
 Lumen: 100LM
 Battery: 4AA(not included)
 Color: White/Black
 Mode: OFF/Eco
 (Sensor with 50% output)/High
 (Sensor with 100% output)
 IPX5



Function 1
Wall Light



Function 2
LED Spike



Accessories



● GLED-175BOS

LED GARDEN

HOT Selling

SPIKE 2 pcs/pack     

Material: Aluminum + PC
Lamp: 3W 3000K LED / each
Lumen: 270LM total
Cable: AWM 2464 24AWG VW-1
transformer to light: 4M
light to light: 2M
Output: 6V 1000MA
Input: 100-240V 50/60Hz
Color: Black

“ A must-have basic & essential item that every store needs! With complete CE/ RoHS/ErP testing report, we provide you a quality-guaranteed hot selling product.



Features

- Complete testing reports
CE(EMC/LVD), RoHS, ErP, we bring you high quality garden spike
- Durable & Long Lasting Use
The spike light is made of solid Aluminum, and it is designed to be long-lasting.
- Basic and essential
The classic & low-key spike matches all kinds of houses & gardens. A must-have item for every DIY store.

Accessories

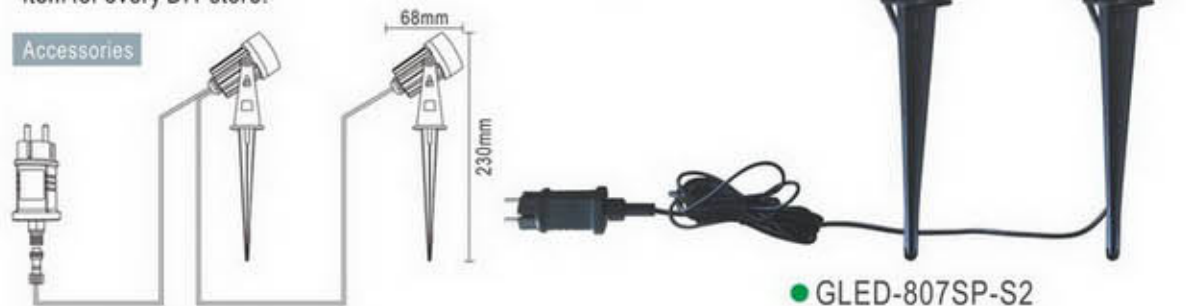

GARDEN

SPOT LIGHT

ENERGY SAVING



Material: PP
Bulb Adaptable: E27 230v 100W Max. Par38 Bulb (Excl.)
With 1.5m 2G1.0mm2 Rubber Cable + VDE Plug
Color: Black
IP44

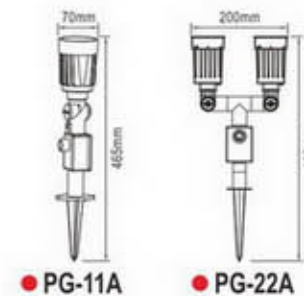

LED GARDEN SPOT LIGHT



Set of 2
Lumen: 2 x 125LM (4000K)
Each Fitting with 1M SPT-2W (18awg) /
H05RN-F 2 x 0.75mm² Cable
Each set with 4M SPT-2W (18awg) /
H05RN-F 2 x 0.75mm² Extension Cable
With Outdoor Driver
IP44



● **GLED-320SP-S2(Juno)**
Material: Die Cast Aluminum + Glass
Per Head with 3W High Power LED
Finish: Black/White/Silver



● **GLED-862SP-S2(Vesta)**
Material: Zinc Alloy + Aluminum + Glass
Per Head with 1 x 3W High Power LED
Finish: Black/White



● **GLED-863SP-S2(Nox)**
Material: Zinc Alloy + Aluminum + Glass
Per Head with 1 x 3W High Power LED
Finish: Black/White

2 in 1 LED UNDER WATER SPOT LIGHT

Premium

Material: Solid Alu. Body
Lamp: 1W&3W LED (6000K/Cool White)
Finish: Aluminum Anodize
IP68



● **GLED-36BA/SP**
1W 6000K 80Lm Build-in Driver
3W 6000K 220Lm Build-in Driver



Option 1
● **GLED-36BA**
2.5M H05RN-F Cable
IP68 VDE Plug

Option 2
● **GLED-36SP**
2.5M H05RN-F Cable
IP68 VDE Plug



Option 2
● **GLED-311SP**
2.5M H05RN-F Cable

Option 1
● **GLED-311BA**
2.5M H05RN-F Cable



● **GLED-311BA/SP**
3 x 1W = 3W
6000K: 210Lm
Build-in Driver

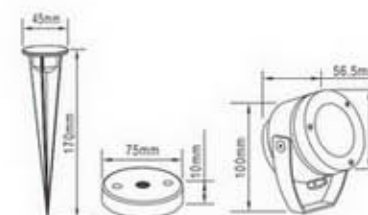

ENERGY SAVING

ALUMINUM SPOT LIGHT

Material: Brushed Aluminum Alloy + Glass Shade
IP44

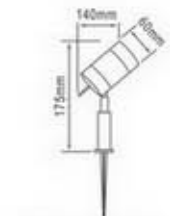

● GL-860SP
MR16 5W LED Bulb

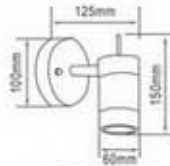

● EL-860DN
GU10 5W LED Bulb

• Assembly

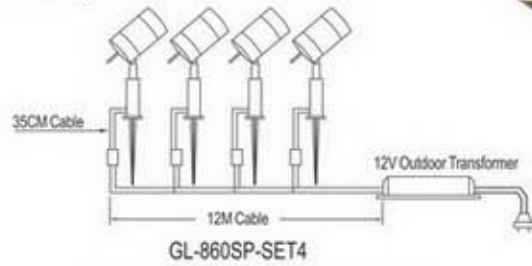

Material: Die Cast Aluminum + Glass Lens
Bulb Adaptable: MR16 5W LED Bulb
Finish: Aluminum
IP44

● GL-840SP

• Assembly

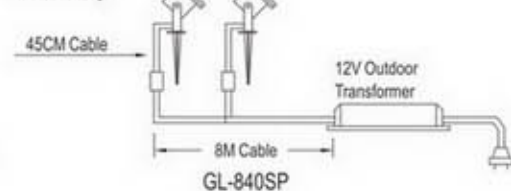

GARDEN

SPOT LIGHT

• Assembly

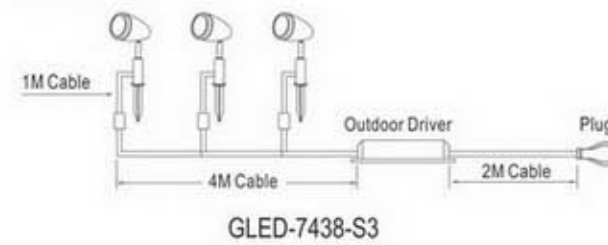

GLED-7438-S3

Set of 3

Material: Aluminum + Glass
Per Head with 1x3w High Power Led
Lumen: 3 x 270LM (4000K)
Each Fitting with 1M SPT-2W (18awg)
H05RN-F 2x0.75mm² Cable + 01 PLug
Each Set with 4M SPT-2W (18awg)
H05RN-F 2x0.75mm² Cable
+ Water-proof Female Plug + 01 Plug
With Outdoor Driver
Finish: Aluminum / Black
IP44

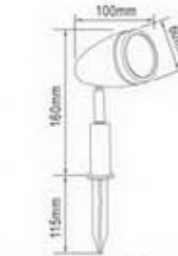

● GLED-7438



Material: Die Cast Aluminium Body + Glass
Bulb Adaptable: GU10 5W LED Bulb
Finish: Matt Black / Alu.
IP44



● WG-851

Material: Die Cast Aluminum Body + Glass Diffuser
+ Plastic Spike
Bulb Adaptable: GU10 5W LED Bulb
With 1M H05RN-F 3x1.0mm² Cable + Connection Box
IP44

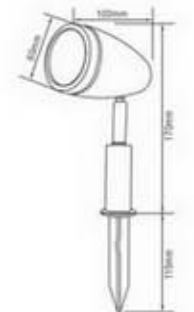

● GL-7438



LED SPOT LIGHT

Material: Die-cast Aluminum
Bulb Adaptable: GU10 50W LED Bulb (Excl.)
IP54



● GL-810SP

● GL-830SP

● GL-820SP

● GL-850SP

LED GARDEN LIGHT

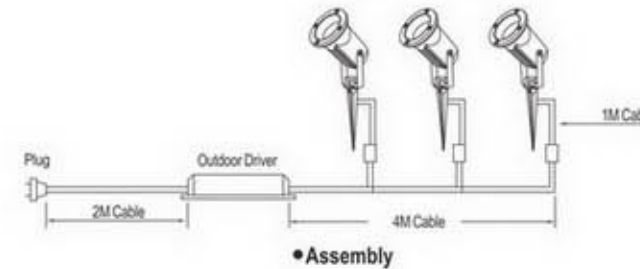

Set of 3
Material: Aluminum Die-Cast + Glass
Lamp: Per head with 1 x 3W COB LED
Color Temperature: 2700~6500K
Lumen: 3 x 100LM (4000K)
Each Fitting with 1M SPT-2W (18awg)
1M H05RN-F 2 x 0.75mm² Cable + DC Plug
Each Set with 4M SPT-2W (18awg)
4M H05RN-F 2 x 0.75mm² Extension Cable
+ Waterproof Female Plug + DC Plug
With Outdoor Driver
Finish: Black
IP44



● GLED-850SP-S3

NEW
Products



Material: Die-Cast Aluminum + Plastic
 Voltage: AC100-240V
 Lamp: 2W(11pcs x 2W Everlight 2835 LED)
 Color Temperature: 3000K
 With 15cm Cable
 Color: Silver
 IP65

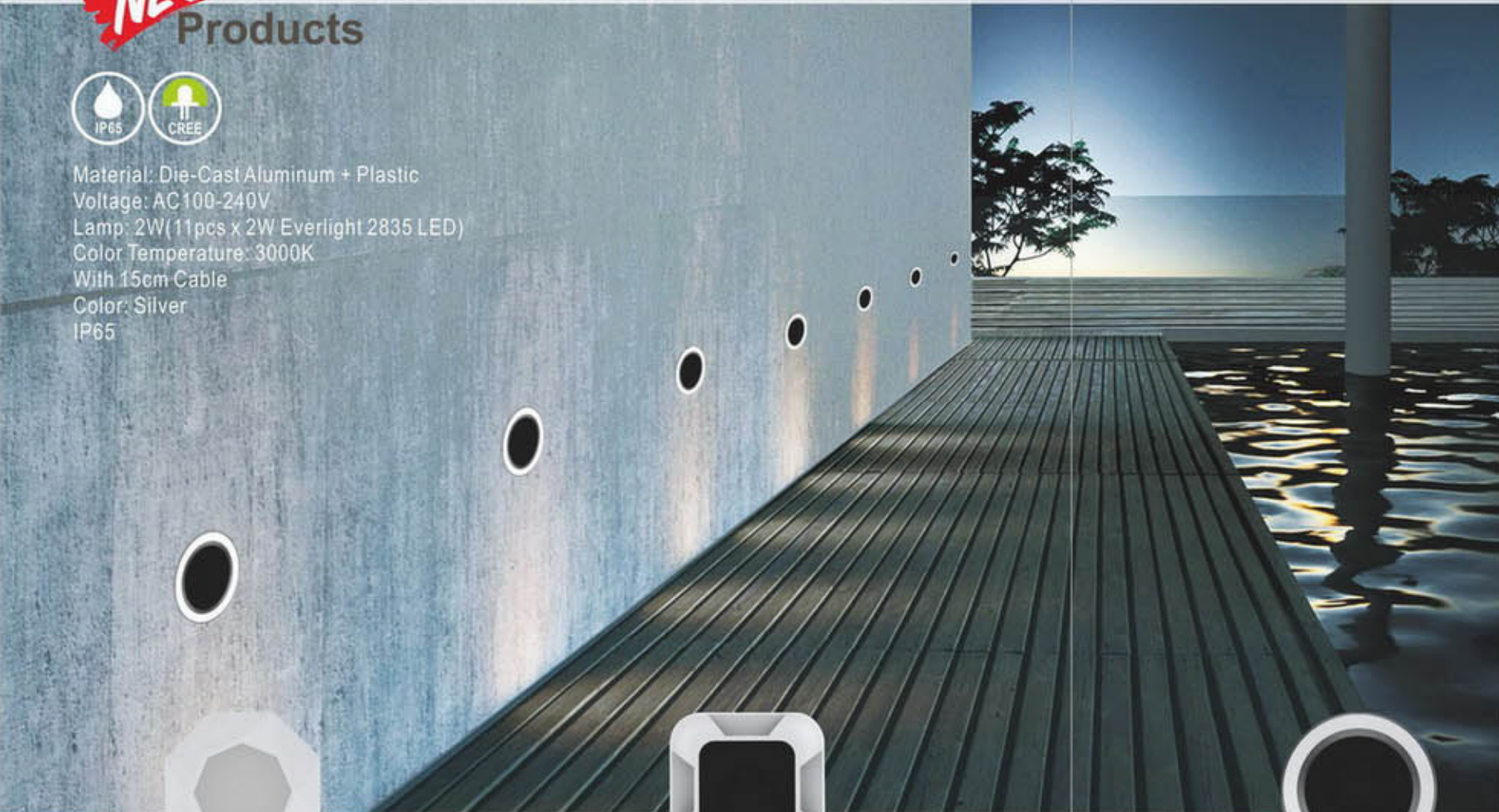

LED EXTERIOR
RECESSED
 WALL LIGHT

Material: Die-Cast Aluminum + Plastic
 Voltage: AC100-240V
 Lamp: 2W(11pcs x 2W Everlight 2835 LED)
 Color Temperature: 3000K
 With 15cm Cable
 Color: Silver
 IP65



● GLED-158A



● GLED-159A



● GLED-160A



● GLED-160B

LED EXTERIOR **RECESSED** WALL LIGHT



Material: Die-Cast Aluminum + PC
Lamp: 3W (6×0.5W LED)
LED Brand: CREE XTE
Color Temperature: 3000K-6000K
Lumen: 110LM
Color: Black
With Waterproof Driver
IP65

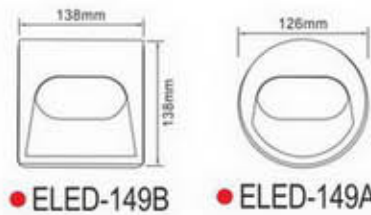

● ELED-149B ● ELED-149A



Material: Aluminum
Voltage: 220-240V
Lamp: 3W (1pc × 3W CREE LED)
Lumen: 160LM
Finish: Stainless Steel
IP54



● GLED-150 ● GLED-151

Material: Die-Cast Aluminum + Plastic
Voltage: AC100-240V
Lamp: 2W (11pcs × 2W Everlight 2835 LED)
Color Temperature: 3000K
Color: Silver
IP65



● GLED-153A ● GLED-153B

Material: Die-Cast Aluminum + Plastic
Voltage: AC100-240V
Lamp: 2W (11pcs × 2W Everlight 2835 LED)
Color Temperature: 3000K
With 15cm cable
Color: Silver
IP65

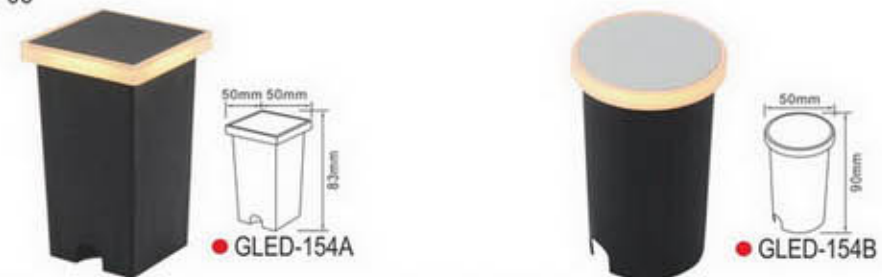

● GLED-154A ● GLED-154B

LED DECK LIGHT SET



Set of 6
Material: Stainless Steel + Tempered Glass
With 5W VDE Driver
RGB type is optional
Finish: Stainless Steel
IP67

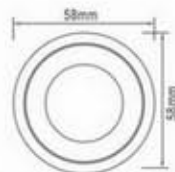

DKLED-60-S6

Lamp: 6 x 0.5W SMD3350 LED (6000K)
Lumen: 7LM (6000K) per Light

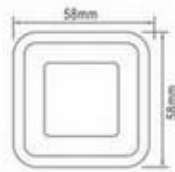

DKLED-61-S6

Lamp: 6 x 0.6W SMD3350 LED (6000K)
Lumen: 9LM (6000K) per Light



Super Thin 9mm Thickness

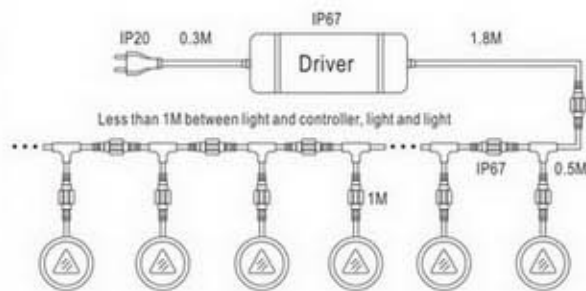

LED DECK LIGHT SET

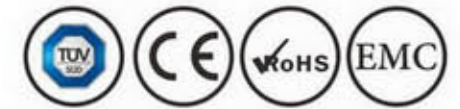

Set of 6
Material: Stainless Steel + PC
With 5W VDE Driver
Finish: Stainless Steel
IP67



DKLED-63-S6

Lamp: 6 x 0.3W SMD3528 LED (6000K)
Lumen: 9 LM (6000K) per Light

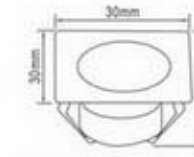

DKLED-65-S6

Lamp: 6 x 0.6W SMD2835 LED (6000K)
Lumen: 40 LM (6000K) per Light
RGB type is optional

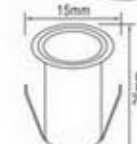

DKLED-64-S6

Lamp: 6 x 0.4W SMD3528 LED (3000K)
Lumen: 7 LM (3000K) per Light



DKLED-62-S6

Lamp: 6 x 0.4W SMD5050 RGB LED
Lumen: 4LM (RGB) per Light
With IR RGB Controller(3M, 360°)

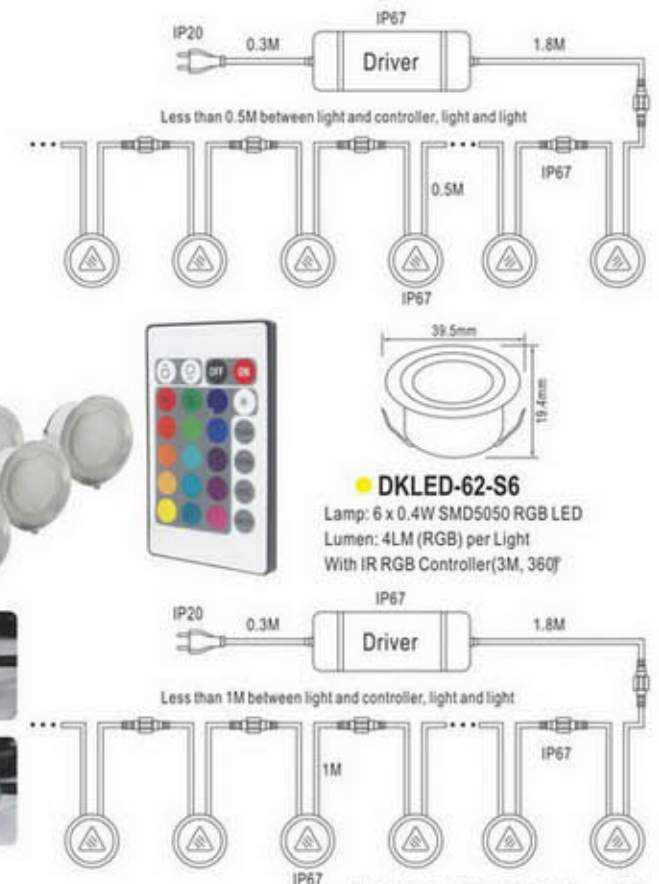

LED IN-GARDEN LIGHT



Material: 304 Stainless Steel Cover

+ Die-Casting Aluminum Body + PP Housing

+ Clear Glass Diffuser

Voltage: 220V ~ 240V

Finish: Stainless Steel Natural Color for Cover + Black Color for Housing

IP67



●	Lamp	Lumen	Product size
● GLED-147	3W (1 x 3W LED)	215LM (3000K)	Dia. 6.2 x H. 9.8cm
● GLED-SS139	3W (3 x 1W LED)	215LM (3000K)	Dia. 10 x H. 11.5cm
● GLED-139A	3W (3 x 1W LED)	215LM (3000K)	Dia. 16 x H. 10.5cm
● GLED-S139	9W (9 x 1W LED)	720LM (3000K)	Dia. 18 x H. 11.5cm
● GLED-M139	12W (12 x 1W LED)	960LM (3000K)	Dia. 21 x H. 11.5cm
● GLED-L139	18W (18 x 1W LED)	1300LM (3000K)	Dia. 26 x H. 11.5cm
● GLED-139-5	5W (5 x 1W LED)	445LM (3000K)	Dia. 16.2 x H. 10.5cm
● GLED-139-6	6W (6 x 1W LED)	520LM (3000K)	Dia. 16.2 x H. 10.5cm
● GLED-139-9	9W (9 x 1W LED)	720LM (3000K)	Dia. 16.2 x H. 10.5cm



● GLED-139-5



AC Type 2-in-1

LED In-Ground Light & Deck Light

4-in-1 version is optional

Material: Aluminum
 Lamp: 2.4W (8 x 0.3W SMD2835 LED)
 Lumen: 135LM (4000K)
 With 1M 2x0.75mm² H05RN-F Cable
 Finish: Silver / Black
 IP67

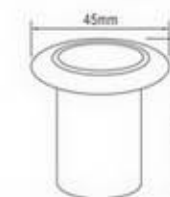

● GLED-148

(1) In-Ground Light



(2) Decking Light



With Red, Green, Blue Color Filters



FLOODLIGHT WORK LIGHT

ALUMINUM **BULKHEADS** STEP LIGHT

Material: Die Cast Aluminum
Bulb Adaptable: E27 5W LED Bulb G45 Type
Finish: Black/White
IP44



● RL-20A

100mm | 233mm — 77mm |

● RL-20C

100mm | 233mm — 77mm |

● RL-20B

100mm | 233mm — 77mm |

NEW
Products



Omni-Directional Adjustable

Material: Die Cast Aluminum Housing + PC
Wattage: 10W, 20W, 30W, 50W, 80W(+/-10%)
Color: White/Black
Efficacy: 80 lm/watt
IP65

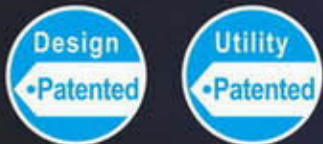

Hey Google, set the flood light to party mode.

Okay.

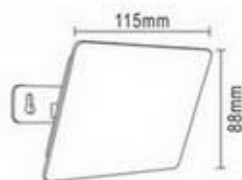

● FLED-747BW-10

Item NO.	Lamp	Lumen	Product Size
● FLED-747BW-10W	10W	800LM	L115xW56xH88mm
● FLED-747BW-20W	20W	1650LM	L131xW60xH95mm
● FLED-747BW-30W	30W	2500LM	L159xW69xH121mm
● FLED-747BW-50W	50W	4200LM	L190xW69xH145mm
● FLED-747BW-80W	80W	6600LM	L224xW78xH169mm

SMART

CONTROL FLOOD LIGHT



Material: Die Cast Aluminum
Build-in Junction Box
Finish: Black
IP65

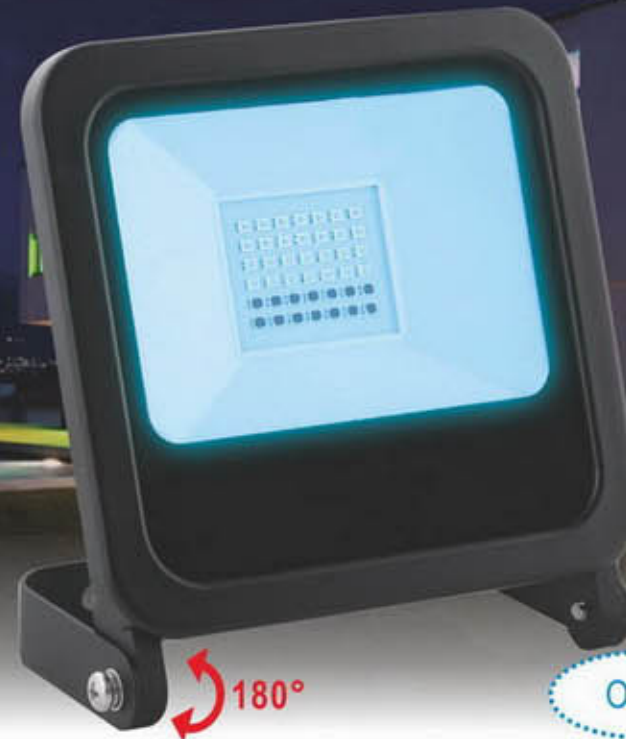

Okay.

Hey Google, set the flood light to party mode.



● FLED-513W-10

●	Lamp	Lumen	Product size(mm)
FLED-513W-10	10W	750LM	L118xW43xH127
FLED-513W-20	20W	1500LM	L126xW43xH142

FULL SCREEN FLOOD LIGHT

HOT Selling

Omni-Directional Adjustable

Material: Die Cast Aluminum Housing + PC
 Wattage: 10W, 20W, 30W, 50W, 80W (+/-10%)
 Sensor: detection range: max6-8M (<24degree)
 Time setting: 10Sec+/-3s, 7min+/-2min,
 ambient light: <10-2000Lux.
 Color: White/Black
 Efficacy: 80 lm/watt
 IP65/IP44



Angle Adjustable Heads & Sensor

747B LED Flood light can be adjusted to the angle you desired. Both Light and Sensor.



Patented Swivel Bracket Design

Unique solid bracket design brings flexibility to accommodate the applications.



Quick Connector Design

Quick Connector helps the installation easier and safer.



Frameless Full Screen

Patented Swivel Bracket Design

Excellent Heat Sink

Quick Connector

Adjustable PIR Sensor

Standard Version

Item NO.	Lamp	Lumen	Product Size
• FLED-747B-10W	10W	800LM	L115xW56xH88mm
• FLED-747B-20W	20W	1650LM	L131xW60xH95mm
• FLED-747B-30W	30W	2500LM	L159xW69xH121mm
• FLED-747B-50W	50W	4200LM	L190xW69xH145mm
• FLED-747B-80W	80W	6600LM	L224xW78xH169mm

Sensor Version

Item NO.	Lamp	Lumen	Product Size
• FLED-747BS-10W	10W	800LM	L115xW62xH121mm
• FLED-747BS-20W	20W	1650LM	L131xW63xH128mm
• FLED-747BS-30W	30W	2500LM	L159xW73xH154mm
• FLED-747BS-50W	50W	4200LM	L190xW73xH178mm
• FLED-747BS-80W	80W	6600LM	L224xW78xH201mm

SLIM LED FLOOD LIGHT

with 3D adjustable Bracket

Material: Die-casting Aluminum Housing + PC
 Voltage: AC 220-240V / 50-60HZ
 Color Temperature: 4000K
 Sensor: With 360° Rotating Bracket
 With Fast Connector
 CRI: Ra:80+
 Color: Black/White
 Waterproof: IP65



Microwave Sensor



Only support Vertical Rotation

Additional support Horizontal Rotation

Additional support Corner Rotation

3 Types Optional Bracket

Item NO.	Lamp	Lumen	Product Size
• FLED-726BS-20	20W(30pcs SMD2835 LED)	1700LM	L148xW57xH160mm
• FLED-726BS-30	30W(42pcs SMD2835 LED)	2550LM	L155xW65xH181mm
• FLED-726BS-50	50W(70pcs SMD2835 LED)	4250LM	L175xW66xH211mm

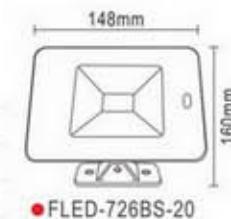

SLIM LED FLOOD LIGHT

with 3D adjustable Bracket

Material: Die-casting Aluminum Housing + PC
Voltage: AC 220-240V / 50-60HZ
Color Temperature: 4000K
Sensor: With 360° Rotating Bracket
With Fast Connector
Color: Black/White
Waterproof: IP65



Detection Range:
9M±2(<24°C)
Detection Angle: 120°
Ambient Light:
5LUX±5LUX-2000LUX Adjustable
Delay Time:
10S±3S-10Min±3Min Adjustable
Working Temperature and Humidity:
<93%RH
Maximum Load: (LED 50W)



Normal Bracket

Only support
Vertical Rotation

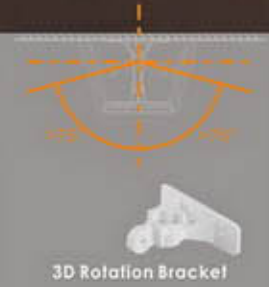

3D Rotation Bracket

Additional support
Horizontal Rotation

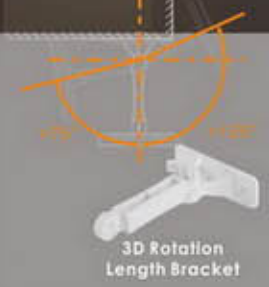

3D Rotation
Length Bracket

Additional support
Corner Rotation



● FLED-727B-20W

3 Types Optional Bracket

Item NO.	Lamp	Product Size	Item NO.	Lamp	Product Size
● FLED-727B-10	10W	L108xW53xH105mm	● FLED-727BS-10	10W	L101xW36xH127mm
● FLED-727B-20	20W	L138xW53xH125mm	● FLED-727BS-20	20W	L133xW39xH153mm
● FLED-727B-30	30W	L182xW71xH158mm	● FLED-727BS-30	30W	L174xW40xH184mm
● FLED-727B-50	50W	L208xW35xH198mm	● FLED-727BS-50	50W	L208xW48xH216mm

SENSOR DETACHABLE LED FLOODLIGHT

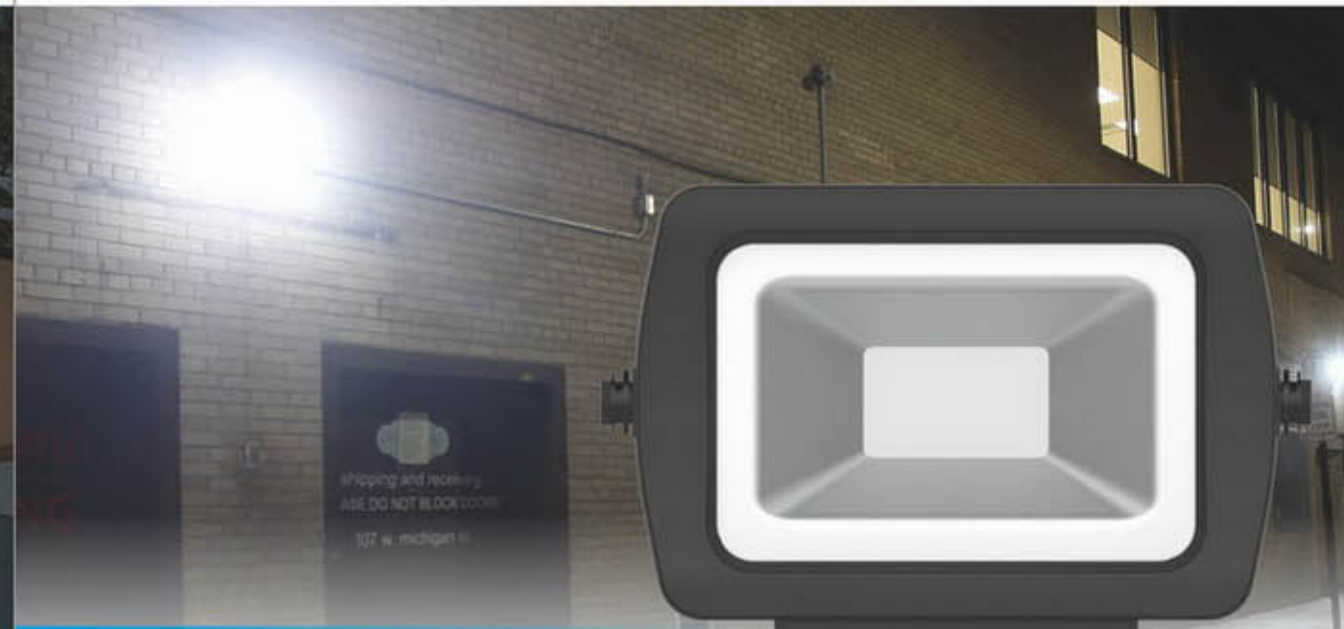

about GRAPHENE...

Excellent Heat Dissipation Performance
Chemical Resistance
Surface Hardness

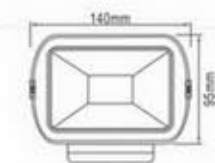

● FLED-597-10W



Material: Graphene + 316 Stainless Steel Bracket
Detachable PIR & Photocell Sensor for Optional
Input Voltage: 200-265V 50/60Hz
Finish: Black
IP65

●	Lamp	Lumen	Product size(cm)
FLED-597-10	10W(15pcs x SMD2835LED)	800LM(4000K)	L 11 x W 16 x H 9
FLED-597-20	20W(30pcs x SMD2835LED)	1600LM(4000K)	L 12.5 x W 17.8 x H 9
FLED-597-30	30W(42pcs x SMD2835LED)	2400LM(4000K)	L 15 x W 22 x H 9
FLED-597-50	50W(56pcs x SMD2835LED)	4000LM(4000K)	L 17 x W 25 x H 9

Easily Change Sensor
by Yourself

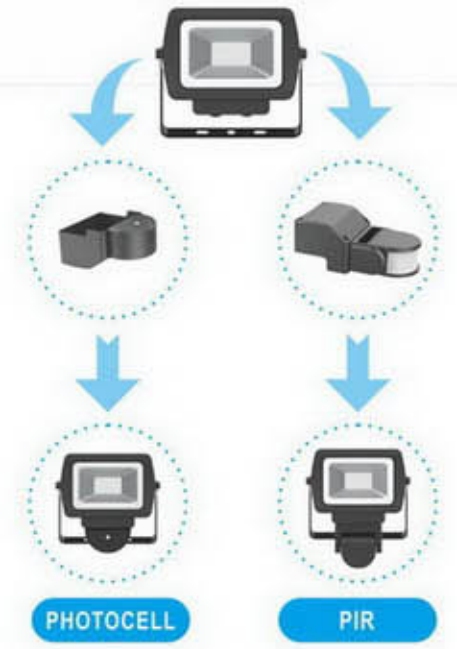

CCT ADJUSTABLE

LED EXTERIOR LIGHT

with PIR Sensor

Wattage: 10W+/-10%, stable watt>9W
 Sensor Detection Range: max6-8M (<24degree)
 Time Setting: 10Sec+/-3s, 7min+/-2min,
 Ambient Light: <10-2000Lux.



CCT Adjustable:
 Cool White
 Natural White
 Warm White



Material: Aluminum body +Glass cover
 Color Temp: 3000K/4000K/6000K
 With PIR sensor
 Color: White/Black
 IP65

Item NO.	Lamp	Product Size
● FLED-695S-10W	10W	L113.4xW64.4xH127.9mm
● FLED-695S-20W	20W	L130.8xW64.4xH147.1mm
● FLED-695S-30W	30W	L147.6xW67.5xH166.3mm
● FLED-695S-50W	50W	L166.8xW67.5xH188mm

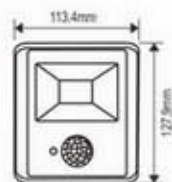

● FLED-695S-10W

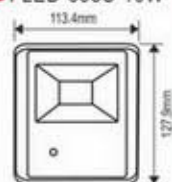

● FLED-695-10W



Item NO.	Lamp	Product Size
● FLED-695-10W	10W	L113.4xW52xH127.9mm
● FLED-695-20W	20W	L130.8xW52xH147.1mm
● FLED-695-30W	30W	L147.6xW56.3xH166.3mm
● FLED-695-50W	50W	L166.8xW56.3xH188mm

LED FLOOD LIGHT

with IC Driver



Material: Aluminium + Glass
 Voltage: AC100-240V
 Color Temperature: 3000K-6500K
 With 15cm 3 x 1.0MM² Rubber Wire
 With IC Driver
 Color: Black/White
 IP65/IP44

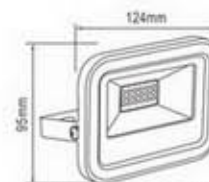

FLED-701-10W

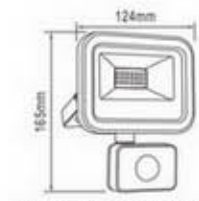

FLED-701S-10W

	Lamp	Lumen	Product Size(mm)
● FLED-701-10	10W(18pcs SMD2835 LED)	800LM	L124 x W95 x H30
● FLED-701-20	20W(36pcs SMD2835 LED)	1600LM	L153 x W117 x H33
● FLED-701-30	30W(60pcs SMD2835 LED)	2400LM	L185 x W139 x H39
● FLED-701-50	50W(100pcs SMD2835 LED)	4000LM	L232 x W175 x H43
● FLED-701-100	100W(200pcs SMD2835 LED)	8000LM	L310 x W240 x H44

	Lamp	Lumen	Product Size(mm)
● FLED-701S-10	10W(18pcs SMD2835 LED)	800LM	L124 x W165 x H51
● FLED-701S-20	20W(36pcs SMD2835 LED)	1600LM	L153 x W187 x H55
● FLED-701S-30	30W(60pcs SMD2835 LED)	2400LM	L185 x W209 x H55
● FLED-701S-50	50W(100pcs SMD2835 LED)	4000LM	L232 x W245 x H58
● FLED-701S-100	100W(200pcs SMD2835 LED)	8000LM	L241 x W314 x H45

LED FLOOD LIGHT

with Junction Box

AC Type



Material: Aluminum + Glass
 Voltage: AC220-240V
 Color Temperature: 3000K-6500K
 Color: Black / White
 With 15cm 3 × 1.0MM² Rubber Wire
 With Junction Box
 IP65 / IP44

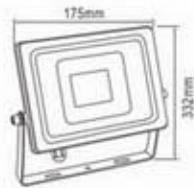

● FLED-735-20W

	Lamp	Lumen	Product Size(mm)
● FLED-735-10W	10W(14pcs SMD2835 LED)	800LM	L105 × W88 × H294
● FLED-735-20W	20W(28pcs SMD2835 LED)	1600LM	L175 × W114 × H332
● FLED-735-30W	30W(70pcs SMD2835 LED)	2400LM	L213 × W142 × H353
● FLED-735-50W	50W(70pcs SMD2835 LED)	4000LM	L241 × W163 × H373

	Lamp	Lumen	Product Size(mm)
● FLED-735S-10W	10W(14pcs SMD2835 LED)	800LM	L138 × W149 × H294
● FLED-735S-20W	20W(28pcs SMD2835 LED)	1600LM	L175 × W175 × H332
● FLED-735S-30W	30W(70pcs SMD2835 LED)	2400LM	L213 × W203 × H353
● FLED-735S-50W	50W(70pcs SMD2835 LED)	4000LM	L241 × W224 × H373

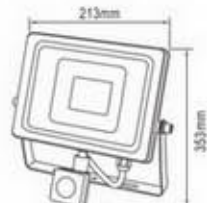

● FLED-735S-30W

Sensor: 8M; 120°; 8-10Mins

RECHARGEABLE & PORTABLE LED FLOODLIGHT

Rechargeable by Li-batteries, 12V/24V Car charger and mains charger



Material: Steel Stand + Aluminum Heat Sink/Reflector
 + ABS Housing + Tempered Glass Diffuser
 Color Temperature: 2700K ~ 6500K
 Accessories: Batteries, Car Charger and Mains Charger (Incl.)
 On/Off Switch
 Finish: Black Body + Yellow Stand
 IP65



● FLED-556P1-10



	Lamp	Working Time	Charging Time	Rechargeable Batteries	Lumen(6000K)	Product Size
● FLED-556P1-10	10W(8pcs x 1W SMD2835 LED)	3H	2.5H	7.4V 1500mAh	500LM	L145 × W165 × H275mm
● FLED-556P1-20	20W(20pcs x 1W SMD2835 LED)	3H	4H	7.4V 3000mAh	1000LM	L215 × W185 × H315mm

SLIM & PORTABLE LED FLOODLIGHT



Material: ABS + Aluminum + Glass
Lamp: COB LED
Input Voltage: AC 85-265V
Battery: 3.7V 220mAh Rechargeable
18650 Lithium Battery
With Main Charger and Car Charger
Charger Output: DC 4.2V 1000mA
Color: Black + Yellow
IP44

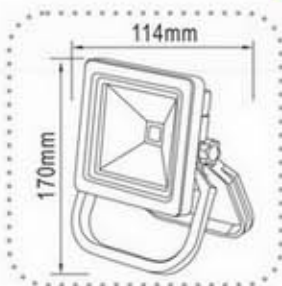

• FLED-651P5-10

Medium

•	Lamp	Batteries Q'ty & Total Capacity	Lumen(6000K)	Product Size
FLED-651P5-10	10W COB	1pc(3.7V, 2200mAh)	500LM	L114 × W57 × H170mm
FLED-651P5-20	20W COB	2pcs(3.7V, 4400mAh)	1000LM	L160 × W65 × H230mm
FLED-651P5-30	30W COB	4pcs(7.4V, 4400mAh)	1500LM	L225 × W75 × H272mm
FLED-651P5-50	50W COB	8pcs(14.8V, 4400mAh)	2500LM	L225 × W75 × H272mm

Battery Working Time: 2H; Battery Charging Time: 3-4H



Exclusive
for North
Europe

FLUORESCENT WORK LIGHT

Material: Base (ABS) + Ball (PE)
Bulb Adaptable: E27 20W LED Corn Bulb
Voltage: 230V
6M H07RN-F 3G 1.5MM² Cable + Plug
IP44



• OS-40PR

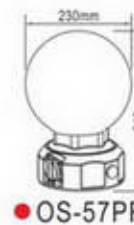

• OS-57PR



BULKHEAD



ENERGY SAVING BULKHEAD

Material: Stainless Steel Cover + PC Body

Lamp: E27 / 10W LED Bulb or 14W Energy Saving Bulb (Excl.)

Finish: Stainless Steel / Silver Grey / Dark Grey / Black

IP44

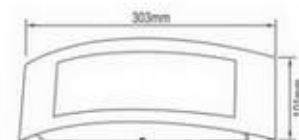

● AL-168A



● AL-168B



● AL-168C

LED BULKHEAD

AC Type

Material: ABS Body + PC Diffuser

Voltage: AC 180V ~ 260V

Color Temperature: 2700K ~ 6500K

Finish: White / Black

Without Driver

IP54

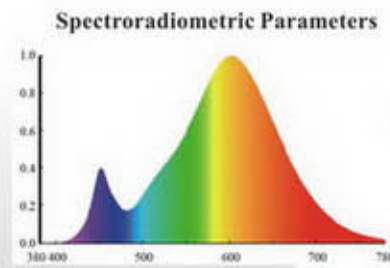

●	Watt	Lamp	Lumen	Product size
ALED-573	5W	18pcs x 0.3W SMD2835 LED	400LM (4000K)	L:171 x W:113 x H:70mm
ALED-M573	10W	24pcs x 0.5W SMD2835 LED	800LM (4000K)	L:211 x W:134 x H:77mm
ALED-574	5W	18pcs x 0.3W SMD2835 LED	400LM (4000K)	L:156 x W:139 x H:70mm
ALED-M574	10W	24pcs x 0.5W SMD2835 LED	800LM (4000K)	L:184 x W:169 x H:77mm



●	Watt	Lamp	Lumen	Product size
ALED-573S	5W	18pcs x 0.3W SMD2835 LED	400LM (4000K)	L:171 x W:144 x H:70mm
ALED-M573S	10W	24pcs x 0.5W SMD2835 LED	800LM (4000K)	L:211 x W:185 x H:77mm
ALED-574S	5W	18pcs x 0.3W SMD2835 LED	400LM (4000K)	L:178 x W:156 x H:70mm
ALED-M574S	10W	24pcs x 0.5W SMD2835 LED	800LM (4000K)	L:208 x W:184 x H:77mm

Sensor: 120°, 8~10M, 5 Secs~12 Mins

100 HOMERESOURCE

www.homeresource.com.tw

LED

BULKHEAD

Material: Aluminum Die-Casting Body

+ Opal PC Diffuser

Voltage: 220V ~ 240V

Finish: Black / White / Grey

IP44



● ALED-S583
Lamp: 7W (40 x SMD2835 LED)
Lumen: 550LM (4000K)

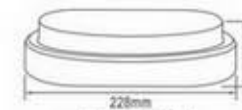

● ALED-583
Lamp: 10W (60 x SMD2835 LED)
Lumen: 850LM (4000K)

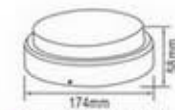

● ALED-S584
Lamp: 7W (40 x SMD2835 LED)
Lumen: 550LM (4000K)

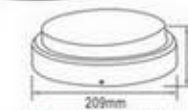
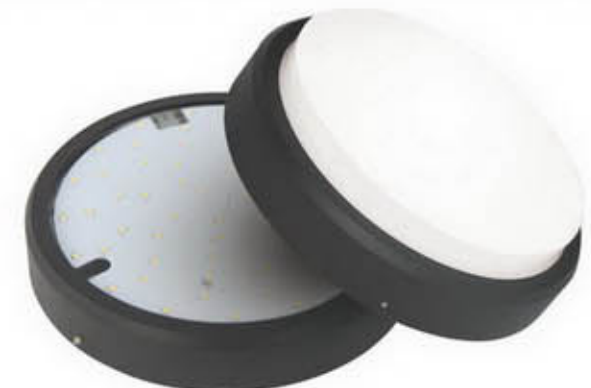

● ALED-584
Lamp: 10W (60 x SMD2835 LED)
Lumen: 850LM (4000K)

www.homeresource.com.tw

HOMERESOURCE 101

ALUMINUM BULKHEADS

Material: Die Cast Aluminum + Glass
Finish: White / Black
IP44



● **AL-512** E27 10W LED Bulb A type
205mm | 315mm — 130mm |
● **AL-512S** E27 5W LED Bulb G45 type
140mm | 210mm — 108mm |

● **AL-514** E27 10W LED Bulb A type
205mm | 315mm — 130mm |
● **AL-514S** E27 5W LED Bulb G45 type
140mm | 210mm — 108mm |

● **AL-520** E27 10W LED Bulb A type
260mm | 260mm — 100mm |
● **AL-520S** E27 5W LED Bulb G45 type
190mm | 190mm — 94mm |

● **AL-522** E27 10W LED Bulb A type
260mm | 260mm — 110mm |
● **AL-522S** E27 5W LED Bulb G45 type
190mm | 190mm — 106mm |

● **AL-524** E27 10W LED Bulb A type
260mm | 260mm — 110mm |
● **AL-524S** E27 5W LED Bulb G45 type
190mm | 190mm — 106mm |

● **AL-533** E27 10W LED Bulb A type
185mm | 280mm — 110mm |

ALUMINUM BULKHEADS

Material: Die Cast Aluminum + Glass
Finish: White / Black
IP44

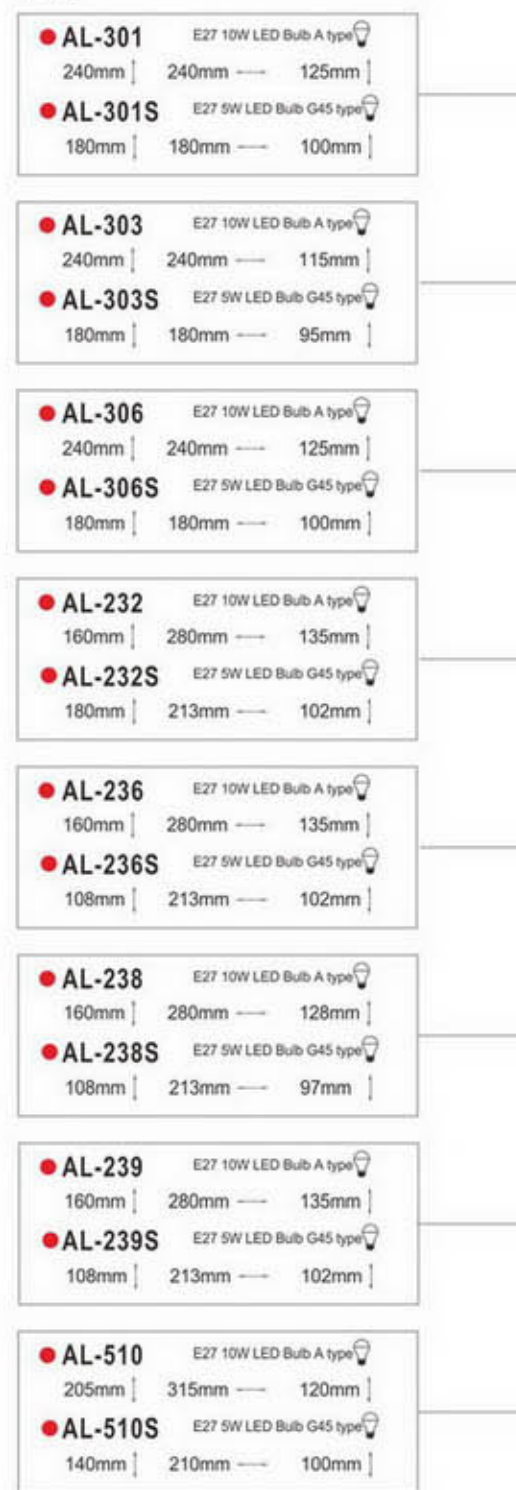

● **AL-301** E27 10W LED Bulb A type
240mm | 240mm — 125mm |
● **AL-301S** E27 5W LED Bulb G45 type
180mm | 180mm — 100mm |

● **AL-303** E27 10W LED Bulb A type
240mm | 240mm — 115mm |
● **AL-303S** E27 5W LED Bulb G45 type
180mm | 180mm — 95mm |

● **AL-306** E27 10W LED Bulb A type
240mm | 240mm — 125mm |
● **AL-306S** E27 5W LED Bulb G45 type
180mm | 180mm — 100mm |

● **AL-232** E27 10W LED Bulb A type
160mm | 280mm — 135mm |
● **AL-232S** E27 5W LED Bulb G45 type
180mm | 213mm — 102mm |

● **AL-236** E27 10W LED Bulb A type
160mm | 280mm — 135mm |
● **AL-236S** E27 5W LED Bulb G45 type
108mm | 213mm — 102mm |

● **AL-238** E27 10W LED Bulb A type
160mm | 280mm — 128mm |
● **AL-238S** E27 5W LED Bulb G45 type
108mm | 213mm — 97mm |

● **AL-239** E27 10W LED Bulb A type
160mm | 280mm — 135mm |
● **AL-239S** E27 5W LED Bulb G45 type
108mm | 213mm — 102mm |

● **AL-510** E27 10W LED Bulb A type
205mm | 315mm — 120mm |
● **AL-510S** E27 5W LED Bulb G45 type
140mm | 210mm — 100mm |

SECURITY LIGHT

Security Light Foldable



Compact package, easy to transform



FEATURES

- (1) Wide range angle adjustable
Solar/Battery version are available



- (2) Compact Design
With PIR Sensor



SPECIFICATIONS

	Version1 Solar & USB Version	Version2 Battery Version
	● SOL-318S-2	● ELED-318S-2
Material	PC+ABS	
Power	8W(40pcs x SMD2835 LED)	
Luminous Flux	400lm	300lm
Solar Panel	5.5V 220mA 1.5W Polycrystalline Silicon Solar Panel	NA
Battery	1x3.7V 4000mAh 18650	3xC battery(exclude)
Charging Time	9 hours	NA
Discharging Time	900 times for 10 sec. lighting	1200 times for 10 sec. lighting
Maximum Detection Range	8m	
Lighting Time Adjustment	3s-7mins	
Lux Adjustment	20-20000 lux	
Sensor Angel	120 degree	
Color	Black	
IP Rating	IP44	

BATTERY OPERATED WALL Security Light



(with Sensor)

Material: Plastic
Color: White /Black
IPX5



• ELED-316S

Lamp: 5.5W(1 COB)
Battery: 3 x D batteries(not included)
Lumen: 350LM
Mode: High(Sensor with 100% output)

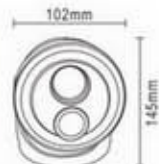

• ELED-317S

Lamp: 8W(16SMD)
Battery: 4 x D batteries(not included)
Lumen: 500LM
Mode: OFF/ON/Eco(Sensor with 50% output)
/High(Sensor with 100% output)

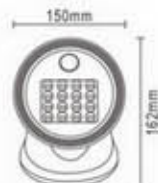

BATTERY OPERATED SECURITY LIGHT

with Sensor



Material: Alu. + ABS + PC
Battery: 3pcs x 1.5V DC AA Battery (Excl.)
PIR Sensor: 8-12m; 140°; 3 secs - 5 mins
Lux Adjustment: 20-10000LX
IP44



Full Screen

• ELED-310S

Lamp: 5W (27pcs x SMD3014 LED)
Lumen: Approx. 300LM

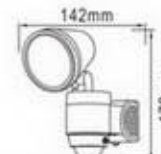

Spot-Single Heads

• ELED-309S-1

Lamp: 3W(6pcs x SMD2835 LED)
Lumen: Approx. 200LM

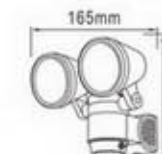

Spot-Double Heads

• ELED-309S

Lamp: 6W(12pcs x SMD2835 LED)
Lumen: Approx. 350LM

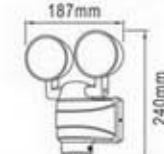

Spot-Double Heads

• ELED-311S

Lamp: 9W(9pcs x SMD2835 LED*2)
Lumen: Approx. 600LM

BATTERY OPERATED

LED SECURITY LIGHT



Material: ABS Body + PC Diffuser + Aluminum Reflector

Battery: 4 x C Excl.

Sensor: 8M, 100°, 5Secs~7Mins, 20~10000Lux

Color: Black/White

IP44

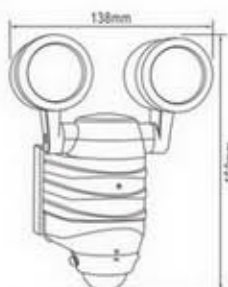

TIME



LUX

● ELED-304S-2

Lamp: 10W (2 x 5W LED)
Lumen: 450LM (6000K)
Battery Working Time: 5H

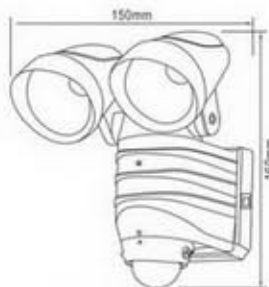

● ELED-303S-2

Lamp: 2W (2 x 1W LED)
Lumen: 100LM (6000K)
Battery Working Time: 12H



PARTY LIGHT

Outdoor



christmas

LED Light



Material: Plastic
10pcs LED G45 Bulb
Transparent Lampshade
With 5M PVC Cable(black)
With 3.5V 3.6W IP44 Transformer + Waterproof Plug
Color: Transparent

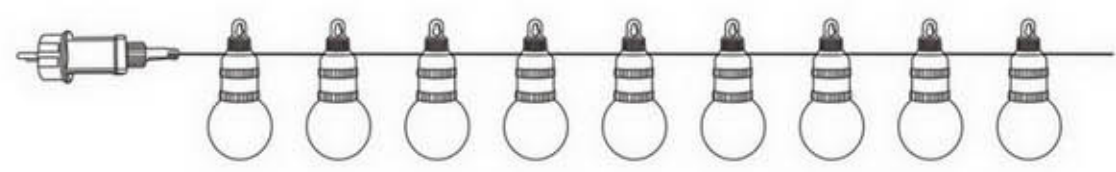
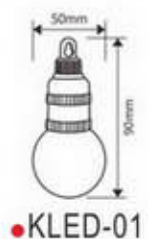

Outdoor



christmas

LED Light



Material: Plastic
10pcs LED G50 Bulb
E40 lamp holder
colorful lampshade
With 3M PVC Cable (black)
With 24V 3.6W IP44 Transformer + Waterproof Plug
Color: Colorful

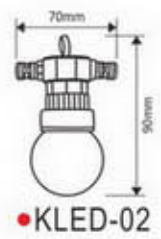
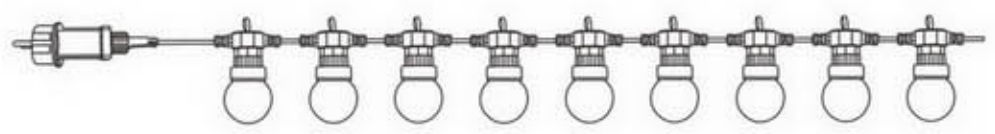

Indoor

Battery Operated christmas LED Light



Material: Plastic
Rated Wattage: 0.36 W
Power Supply: 3xAA Battery 4.5V (excluded)
Working Temperature: -10°C ~ 40°C
IP20

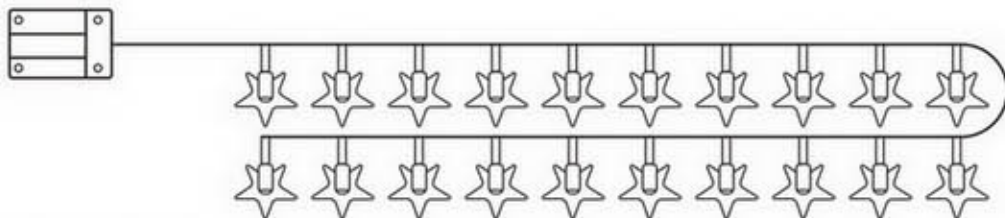

TRI-PROOF HIGH BAY GARDEN SOCKET

LED TRI-PROOF LIGHT



Material: Plastic
 Voltage: AC170-265V 50-60Hz
 Power Factor : PF>0.5
 Beam Angle: 120°
 Working Temperature: -20~40°C
 CRI:Ra>80
 Color: White
 IP65



	Lamp	Lumens	Product Size(mm)
●			
EFLED-606-16W	16W (84pcs x 0.2W SMD2835 LED)	750LM	L622 x W28 x H24.5
EFLED-606-18W	18W (96pcs x 0.2W SMD2835 LED)	1500LM	L622 x W28 x H24.5
EFLED-606-32W	32W (168pcs x 0.2W SMD2835 LED)	1500LM	L1232 x W28 x H24.5
EFLED-606-36W	36W (192pcs x 0.2W SMD2835 LED)	3060LM	L1232 x W28 x H24.5
EFLED-606-40W	40W (240pcs x 0.2W SMD2835 LED)	1800LM	L1532 x W28 x H24.5
EFLED-606-45W	45W (240pcs x 0.2W SMD2835 LED)	3900LM	L1532 x W28 x H24.5

LED TRI-PROOF LIGHT



Material: Plastic
 Voltage: AC170-265V
 Color Temperature: 2700K~7000K
 Beam Angle: 120 Degrees
 Power Factor: >0.9
 CRI 70
 With M20 Joint
 With Openable Cap
 Without Aluminum Heat Dissipation Plate
 Color: White
 IP65

	Lamp	Lumen	Product Size(mm)
●			
EFLED-S607-20W	20W(96pcs SMD2835 LED)	1650LM	L649 x W83 x H63
EFLED-S607-40W	40W(192pcs SMD2835 LED)	3350LM	L649 x W83 x H63



● EFLED-S607-20W

LED

TRI-PROOF LIGHT

Material: PC Housing
 Voltage: 85V ~ 265V
 Color Temperature: 3000K ~ 6000K
 Finish: White
 IP65



● EFLED-400

	Lamp	Lumen	Product size
● EFLED-400(18W)	18W (96pcs x SMD2835 LED)	1710LM(4000K)	L: 65 x W: 5.8 x H: 3.5cm
● EFLED-400(36W)	36W (192pcs x SMD2835 LED)	3420LM(4000K)	L: 125 x W: 5.8 x H: 3.5cm
● EFLED-400(45W)	45W (240pcs x SMD2835 LED)	4275LM(4000K)	L: 155 x W: 5.8 x H: 3.5cm

Material: PC Housing + Aluminum
 Voltage: 85V ~ 265V
 Color Temperature: 3000K ~ 6000K
 Color: White
 IP65



● EFLED-600-18W

	Lamp	Lumen	Product size
● EFLED-600(18W)	18W (96pcs x SMD2835 LED)	1530LM(4000K)	L: 61 x W: 8.2 x H: 4.7cm
● EFLED-600(36W)	36W (192pcs x SMD2835 LED)	3060LM(4000K)	L: 121 x W: 8.2 x H: 4.7cm
● EFLED-600(45W)	45W (240pcs x SMD2835 LED)	3825LM(4000K)	L: 151 x W: 8.2 x H: 4.7cm
● EFLED-600(30W)	30W (180pcs x SMD2835 LED)	2550LM(4000K)	L: 61 x W: 8.2 x H: 4.7cm
● EFLED-600(60W)	60W (288pcs x SMD2835 LED)	5100LM(4000K)	L: 121 x W: 8.2 x H: 4.7cm
● EFLED-600(70W)	70W (384pcs x SMD2835 LED)	5950LM(4000K)	L: 151 x W: 8.2 x H: 4.7cm



● HBLED-28-200 with Beam Angle 120° Reflector



● HBLED-28-60

● HBLED-28-100

● HBLED-28-150

● HBLED-28-200

● HBLED-28DIM-150

LED HIGH BAY LIGHT-UFO

Material: Aluminum Body & Reflector + PC Diffuser
 Voltage: 90V ~ 305V
 Finish: Black Body + Natural Alu. Reflector
 Meanwell Driver
 Beam Angle: 125°
 IP65

Optional Reflector



Beam Angle 60°



Beam Angle 90°



Beam Angle 120°

	Lamp	Lumen
● HBLED-28-60	60W(60 x Philip SMD3030 LED)	7500LM(2700K - 3500K)
● HBLED-28-100	150W(117 x Philip SMD3030 LED)	11000LM(2700K - 3500K)
● HBLED-28-150	150W(182 x Philip SMD3030 LED)	16900LM(2700K - 3500K)
● HBLED-28-200	200W(238 x Philip SMD3030 LED)	21800LM(2700K - 3500K)
● HBLED-28DIM-150	150W(182 x Philip SMD3030 LED)	16900LM(2700K - 3500K)

GARDEN OUTLET

SOCKET



Material: Resin
 Voltage: 230V
 Rated Current: 16A
 With 1.5M H07RN-F3G1.5mm² Cable + VDE Plug
 Finish: Stone / Wood / White
 IP44

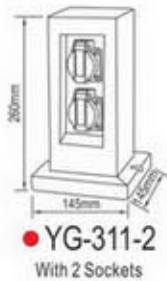

● YG-311-2
 With 2 Sockets



● YG-311TM-2
 With 2 Sockets + 1 Mechanical Timer



● YG-S243-4
 With 4 Sockets



● YG-S243TM-2
 With 2 Sockets + 1 Mechanical Timer

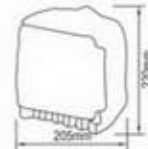

● YG-247-2
 With 4 Sockets



French Socket



German Socket



WALL LIGHT • GARDEN SPIKE • FLOOD LIGHT



Manufacturer • Buying Agent • Inspection Agent



Home Resource Ind. Co., Ltd.

Taipei Headquarter:
 4F, No. 7, Dexing W. Rd., Shilin Dist., Taipei City, Taiwan
 Zhongshan Home Resource Factory:
 No. 8, Yanjiang W. 1st Rd., Keji Ave., Torch Development Zone, Zhongshan City, Guangdong, China
 Ningbo Home Resource Factory:
 Qiaotouhu Industrial Park, Ninghai, Ningbo, China
 Tel: 886-2-2809-1212 (Rep. 12 Lines) E-mail: hr@homeresource.com.tw
 Fax: 886-2-2808-1565
<http://www.homeresource.com.tw>

